

**Chemie-Normpumpe CPK
 Wärmeträger-Umwälzpumpe HPK**

**Standardized Chemical Pump CPK
 Circulating Pumps for Heat Transfer Media HPK**

**Pompes normalisées pour produits chimiques CPK
 Pompes centrifuges pour caloporteurs HPK**

**Bombas químicas estandarizadas CPK
 Bombas centrífugas para aceites caloríficos HPK**

50 Hz, n = 2900, 1450, 960 1/min

Den Kennlinien liegt Abnahmeklasse ISO 2548 bzw. ISO/CD 9906-Klasse 2 zugrunde.

Die in den Kennlinienblättern angegebenen NPSH-Werte sind Meßwerte, die einem Förderhöhenabfall von 3% entsprechen.

NPSH-Wert im Teillastgebiet:

NPSH-Werte für Förderströme kleiner als $Q = 0,3 \times Q_{opt}$ können nur mit sehr hohem Aufwand gemessen werden. Der Nachweis von NPSH-Werten in diesem Förderstrombereich kann nicht akzeptiert werden.

Die Förderhöhen und Leistungsangaben gelten für Fördermedien mit einer Dichte $\rho = 1,0 \text{ kg/dm}^3$ und einer kinematischen Viskosität ν bis max. $20 \text{ mm}^2/\text{s}$. Ist die Dichte $\neq 1,0$, muß die Leistungsangabe mit ρ multipliziert werden.

Bei Viskositäten $> 20 \text{ mm}^2/\text{s}$ sind entsprechende Kaltwasserdaten zu berechnen und der Einfluß auf die Pumpenleistung zu ermitteln. Bei bestimmten Ausführungen (verstärkte Lagerung, bestimmte Wellendichtungen) sind Reibleistungen zu berücksichtigen und als Zusatzleistung im Datenblatt anzugeben.

Diese Drucksache ist unser Eigentum. Sie darf weder vervielfältigt, noch Dritten zugänglich gemacht werden. Zuwiderhandlung verpflichtet zu Schadenersatz.

The performance curves are based on acceptance test class ISO 2548 or ISO/CD 9906 - class 2.

The NPSH values given in the performance curve sheets are measured values which correspond to a loss of discharge head of 3%.

NPSH values at part-load operation:

NPSH values for capacities below $Q = 0.3 \times Q_{optimum}$ can only be measured at considerable expense. Evidence of NPSH values in this range cannot be supplied.

The total heads and the performance characteristics apply to media with a density $\rho = 1.0 \text{ kg/dm}^3$ and a kinematic viscosity ν up to $20 \text{ mm}^2/\text{s}$. If the density is $\neq 1.0$, the friction must be multiplied by ρ .

For viscosities $> 20 \text{ mm}^2/\text{s}$, the cold water data must be calculated and effect of viscosity on pump performance must be determined. On special pump designs (reinforced bearings, special shaft seals) losses friction must be taken into account and indicated separately in the data sheet.

This document remains our property. It must neither be reproduced nor shown or ceded to third parties. Any infringement renders the offending party liable to damages.

Les courbes caractéristiques correspondent au standard de réception ISO 2548 ou ISO/CD 9906 - classe 2.

Les valeurs de NPSH indiquées dans les feuilles de courbes sont des valeurs mesurées correspondant à une perte de la hauteur d'élevation de 3%.

Valeurs du NPSH pour charge partielle:

La mesure des valeurs NPSH, pour des débits inférieurs à $Q = 0,3 Q_{opt}$, est une opération très coûteuse; les valeurs relevées dans cette plage de débits ne peuvent être garanties comme fiables.

Les caractéristiques indiquées sont valables pour un milieu pompé d'une masse volumique égale à 1 et pour une viscosité cinématique n'excédant pas $20 \text{ mm}^2/\text{s}$. Si la masse volumique du milieu pompé a une valeur différente de 1, multiplier les caractéristiques indiquées par cette valeur.

Pour des viscosités $> 20 \text{ mm}^2/\text{s}$ il faut déterminer l'influence de la viscosité sur la puissance de la pompe. Pour certains types de construction (palier renforcé, certaines étanchéités d'arbre), il faut tenir compte de la puissance dissipée par frottement et l'indiquer séparément dans la feuille technique.

Ce document est notre propriété. Il ne peut être ni reproduit, ni communiqué à des tiers. Le non-respect de ces dispositions, nous donnerait droit à dommages et intérêts.

Las curvas características se basan en la clase de recepción ISO 2548 resp. ISO/CD 9906 - clase 2.

Los valores NPSH indicados en las hojas de curvas características son valores de medición, que corresponden a un descenso de la altura de elevación de 3%.

Valores NPSH trabajando la bomba en carga parcial:

Los valores NPSH para caudales menores de $Q = 0,3 \times Q_{optimo}$ pueden ser medidos solamente con grandes dificultades. Las pruebas del NPSH en este sector de caudales no pueden realizarse.

Las alturas de elevación y las indicaciones sobre potencias requeridas son válidas para líquidos a impulsar con una densidad de $\rho = 1,0 \text{ kg/dm}^3$ y una viscosidad cinemática hasta un máximo de $20 \text{ mm}^2/\text{s}$. Si la densidad $\neq 1,0$ debe multiplicarse la potencia por ρ .

En caso de viscosidades $> 20 \text{ mm}^2/\text{s}$ es preciso calcular los datos de agua fría correspondientes y determinar la influencia de la viscosidad en el rendimiento de las bombas. Para ejecuciones determinadas (cojinetes reforzados, juntas de eje determinadas) considerar la potencia de fricción e indicarla como potencia adicional en la hoja de datos.

Este impreso es de nuestra propiedad, no podrá reproducirse ni cederse a terceros. Las contravenciones se sancionan con pago de indemnizaciones por daños y perjuicios.

n = 2900 1/min

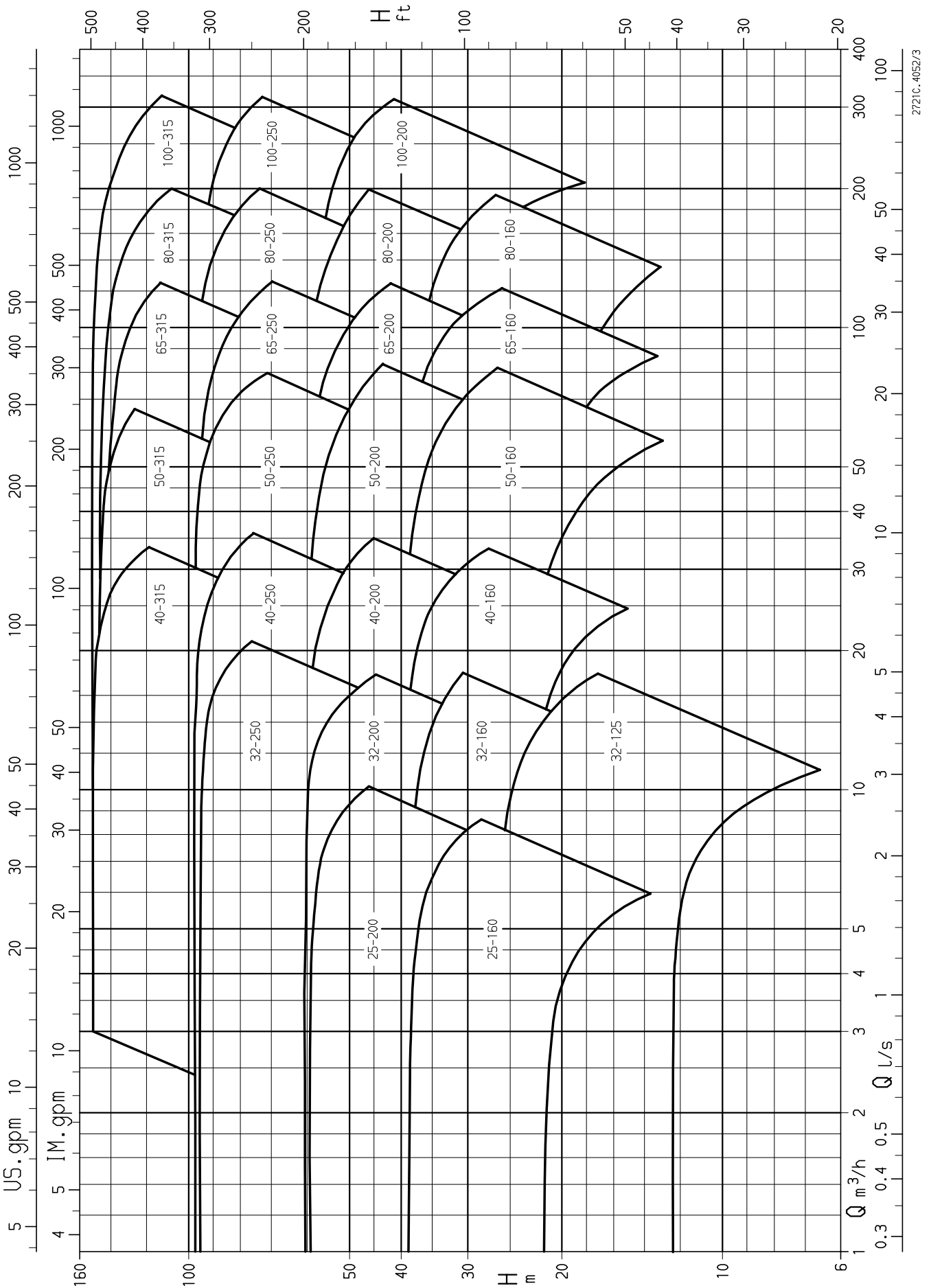

2721C.4052/3

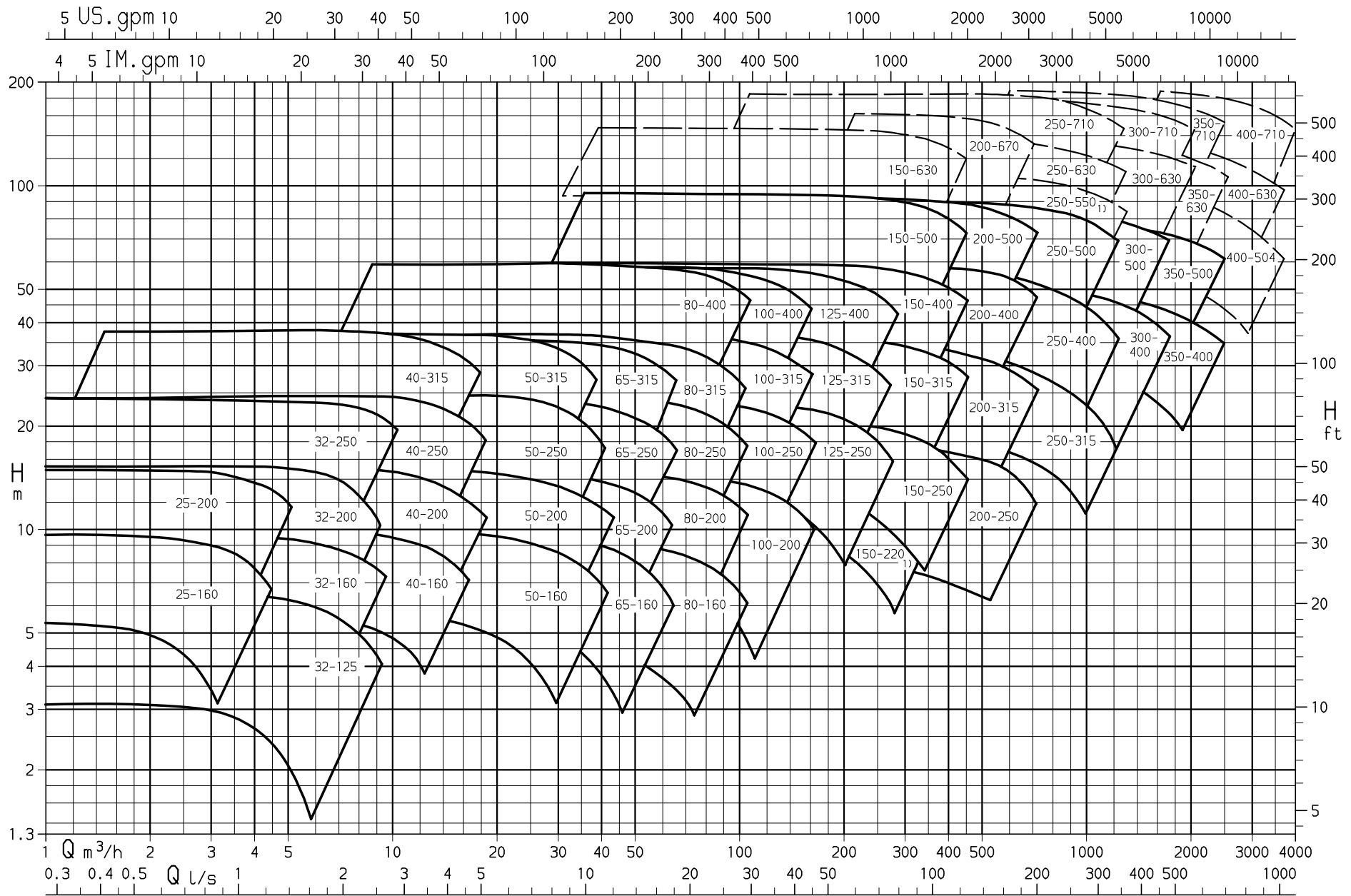

n = 1450 1/min



1) Auf Anfrage 1) on request 1) sur demande 1) según demanda

2721C.4054/3

ω ---- Ergänzungsgrößen; siehe 2721.451 ---- Additional pump sizes; see 2721.451 ---- Autres tailles de pompe; voir 2721.451 ---- Otros tamaños de bombas; véase 2721.451

CPK/HPK

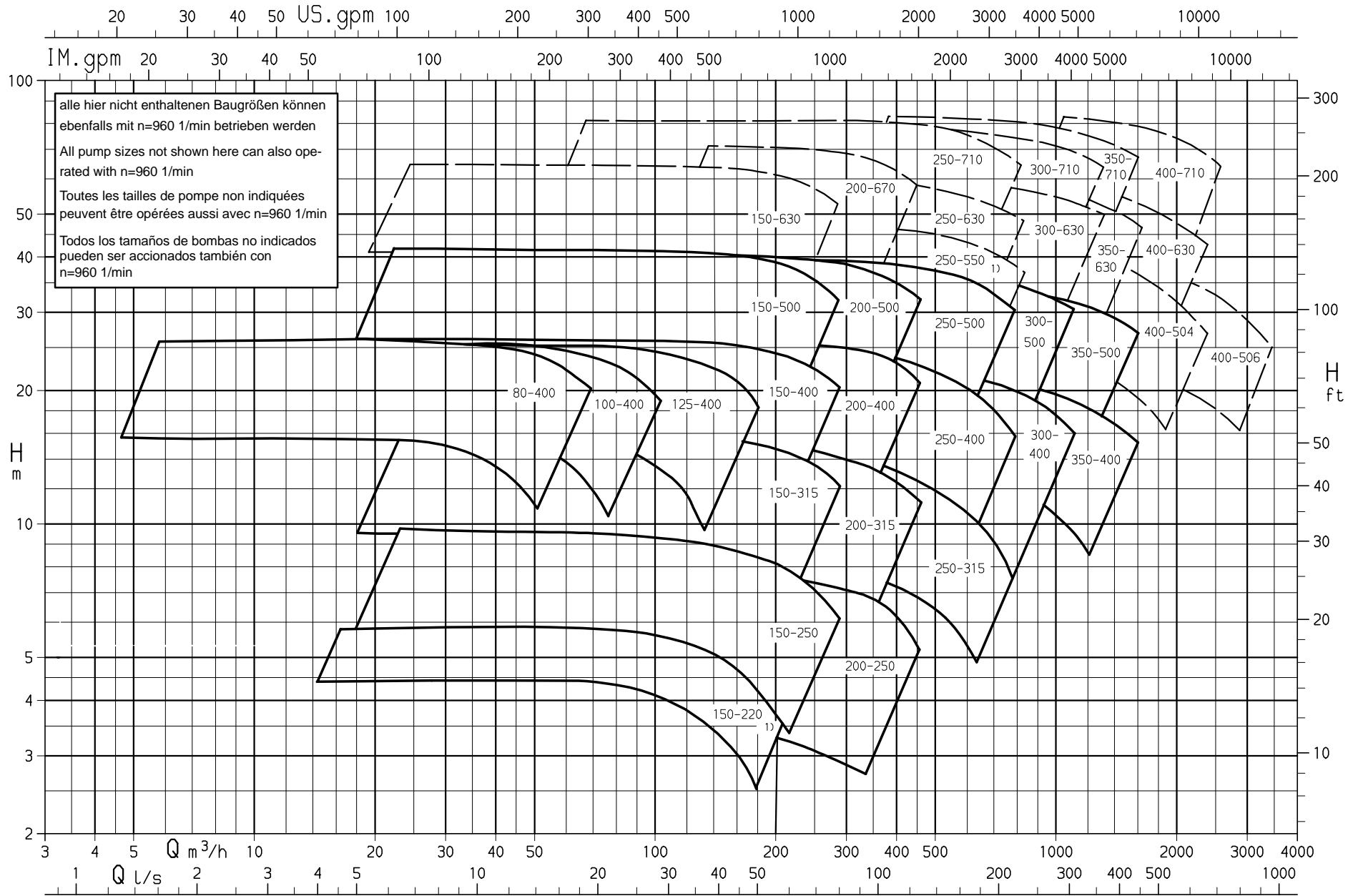

alle hier nicht enthaltenen Baugrößen können ebenfalls mit n=960 1/min betrieben werden
 All pump sizes not shown here can also operated with n=960 1/min
 Toutes les tailles de pompe non indiquées peuvent être opérées aussi avec n=960 1/min
 Todos los tamaños de bombas no indicados pueden ser accionados también con n=960 1/min

n = 960 1/min





CPK/HPK

2721.4056/3

1) Auf Anfrage 1) on request 1) sur demande 1) según demanda
 ---- Ergänzungsgrößen; siehe 2721.451 ---- Additional pump sizes; see 2721.451 ---- Autres tailles de pompe; voir 2721.451 ---- Otros tamaños de bombas; véase 2721.451

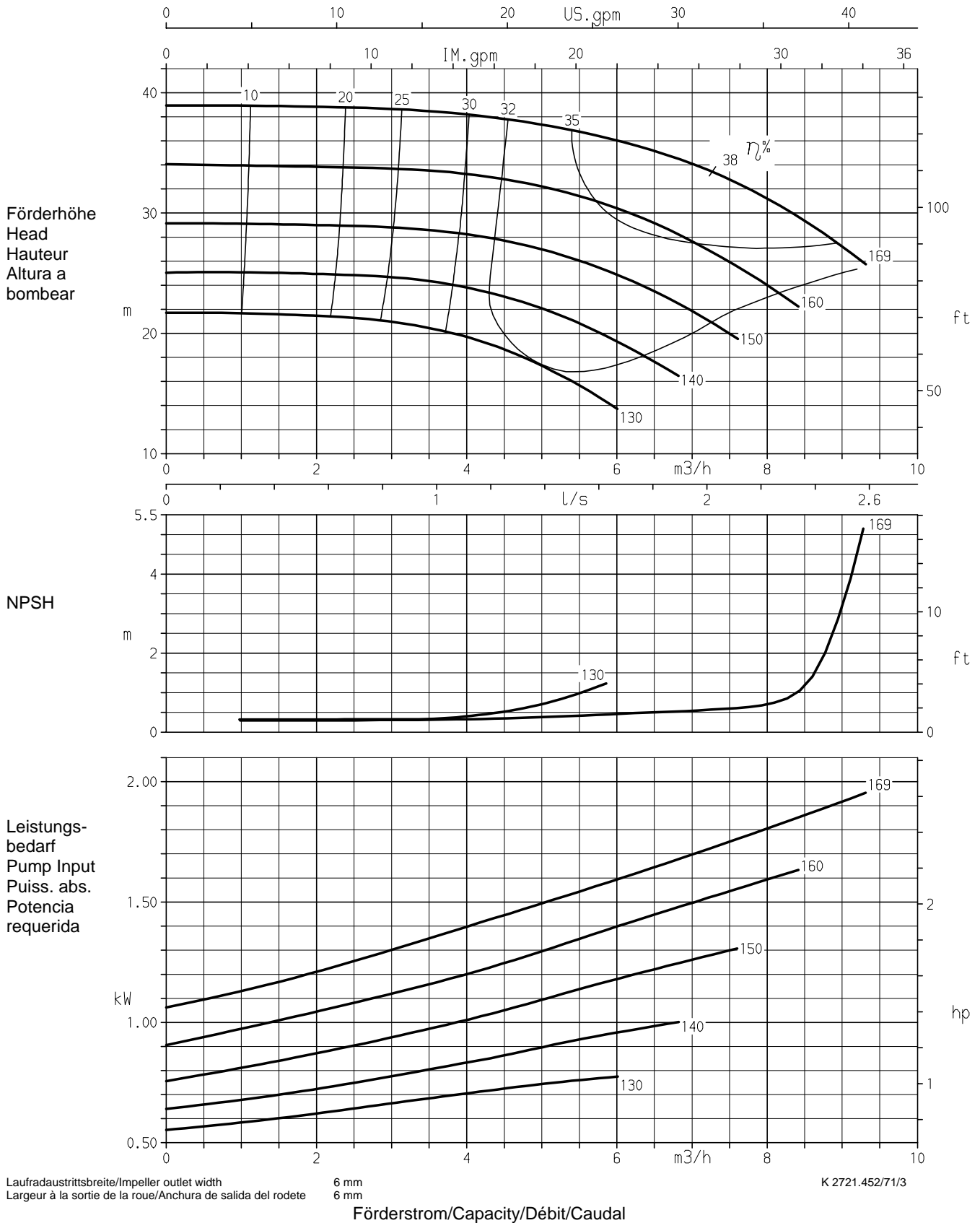
Baureihe Pump type	Modèle Tipo	Nennzahl Nom. speed	Vitesse nom. Revoluciones nom.	 KSB KSB Aktiengesellschaft Pumpen Industrie- und Wassertechnik Postfach 13 60, D-91253 Pegnitz Bahnhofplatz 1, D-91257
CPK/HPK	25-160	2900 1/min		
Angebots-Nr. Project No.	No. de l'offre Oferta-No.	Pos.-Nr. Item No.	No. de pos. No. de pos.	



Baureihe Pump type	Modèle Tipo	Nenn Drehzahl Nom. speed	Vitesse nom. Revoluciones nom.	 KSB KSB Aktiengesellschaft Pumpen Industrie- und Wassertechnik Postfach 13 60, D-91253 Pegnitz Bahnhofplatz 1, D-91257
CPK/HPK	25-200	2900 1/min		
Angebots-Nr. Project No.	No. de l'offre Oferta-No.	Pos.-Nr. Item No.	No. de pos. No. de pos.	

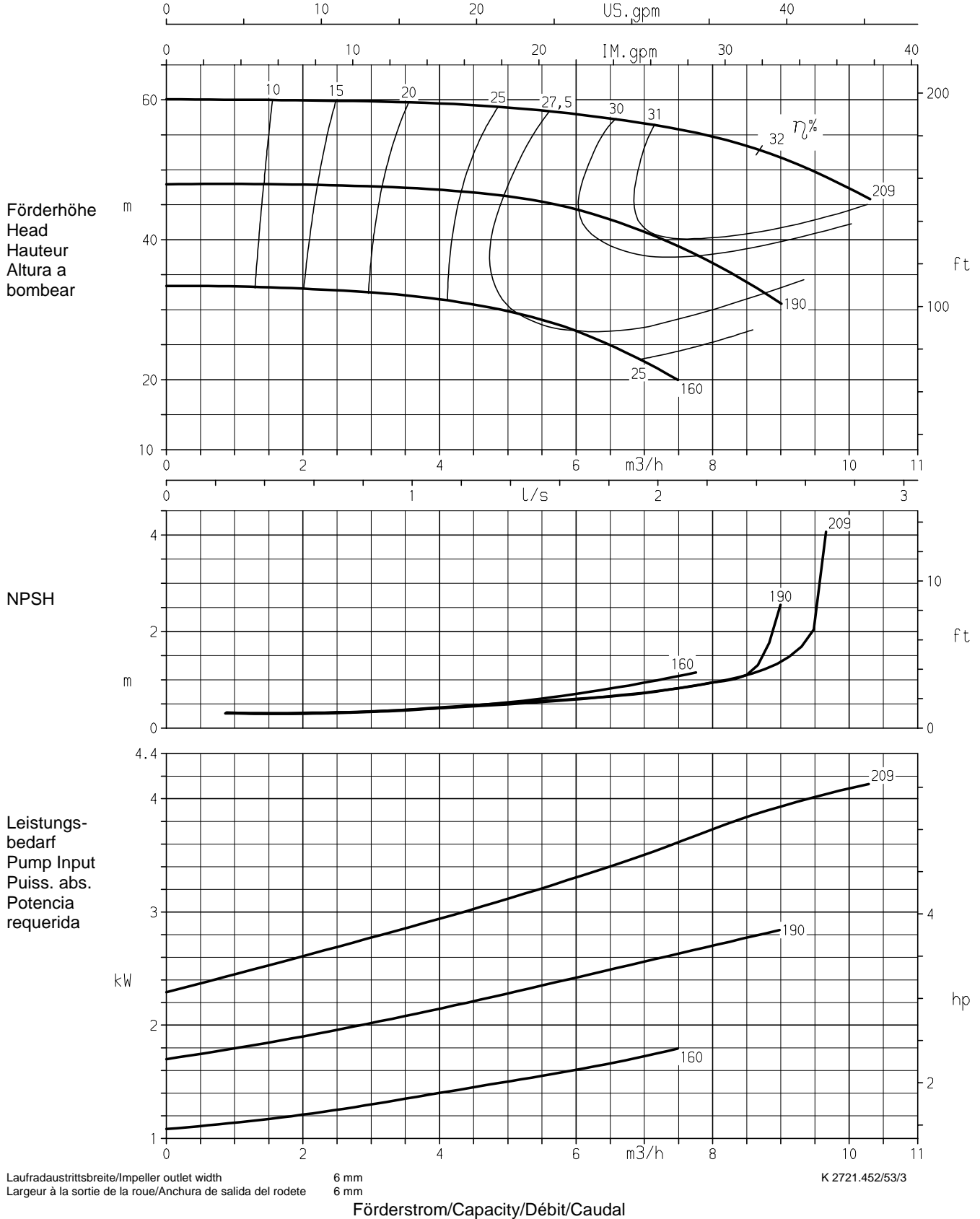

Baureihe Pump type	Modèle Tipo	Nenn Drehzahl Nom. speed	Vitesse nom. Revoluciones nom.	 KSB KSB Aktiengesellschaft Pumpen Industrie- und Wassertechnik Postfach 13 60, D-91253 Pegnitz Bahnhofplatz 1, D-91257
CPK/HPK	32-125	2900 1/min		
Angebots-Nr. Project No.	No. de l'offre Oferta-No.	Pos.-Nr. Item No.	No. de pos. No. de pos.	

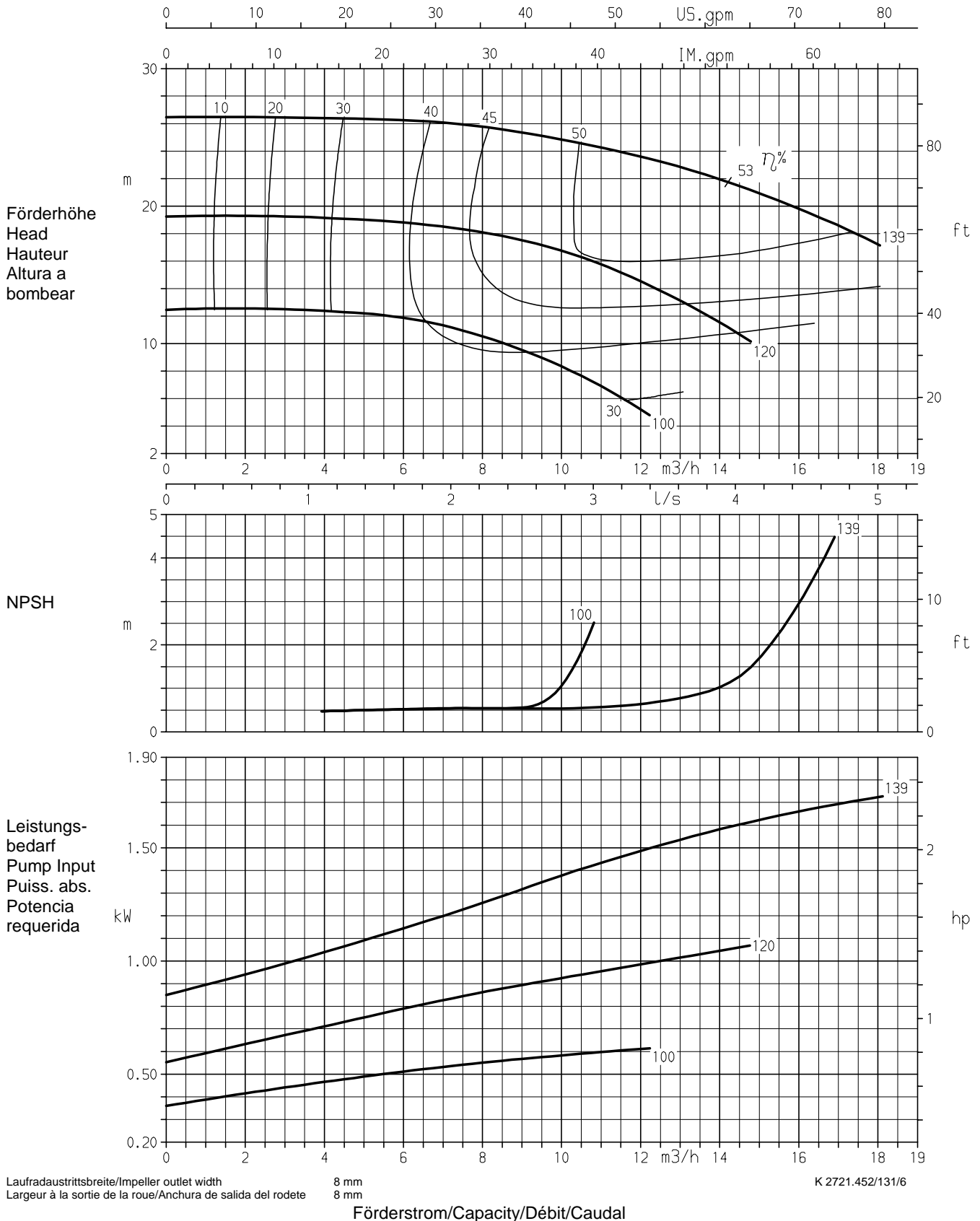

Baureihe Pump type	Modèle Tipo	Nenn Drehzahl Nom. speed	Vitesse nom. Revoluciones nom.	 KSB KSB Aktiengesellschaft Pumpen Industrie- und Wassertechnik Postfach 13 60, D-91253 Pegnitz Bahnhofplatz 1, D-91257
CPK/HPK	32-160	2900 1/min		
Angebots-Nr. Project No.	No. de l'offre Oferta-No.	Pos.-Nr. Item No.	No. de pos. No. de pos.	

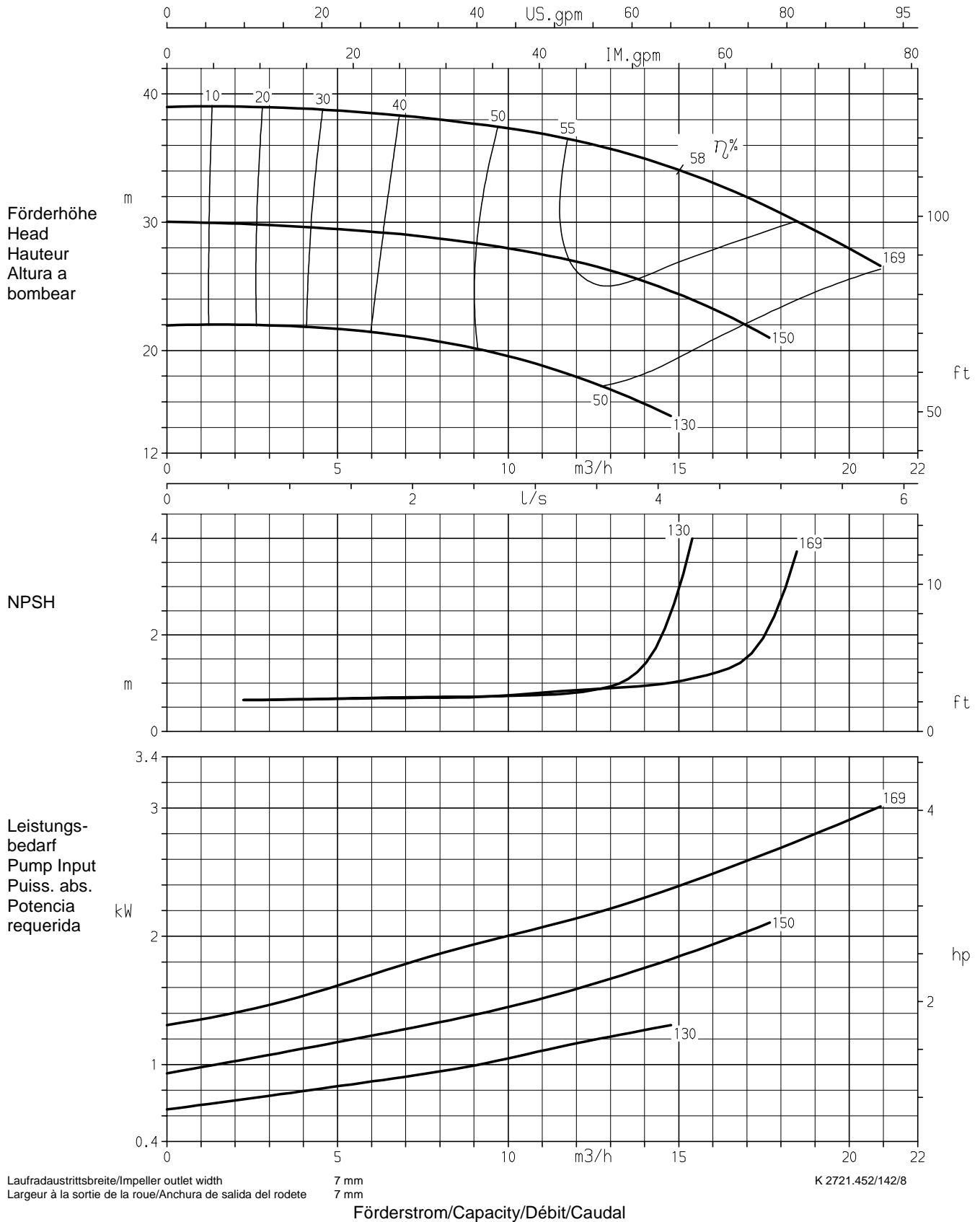

Baureihe Pump type	Modèle Tipo	Nenn Drehzahl Nom. speed	Vitesse nom. Revoluciones nom.	 KSB KSB Aktiengesellschaft Pumpen Industrie- und Wassertechnik Postfach 13 60, D-91253 Pegnitz Bahnhofplatz 1, D-91257
CPK/HPK	32-200	2900 1/min		
Angebots-Nr. Project No.	No. de l'offre Oferta-No.	Pos.-Nr. Item No.	No. de pos. No. de pos.	

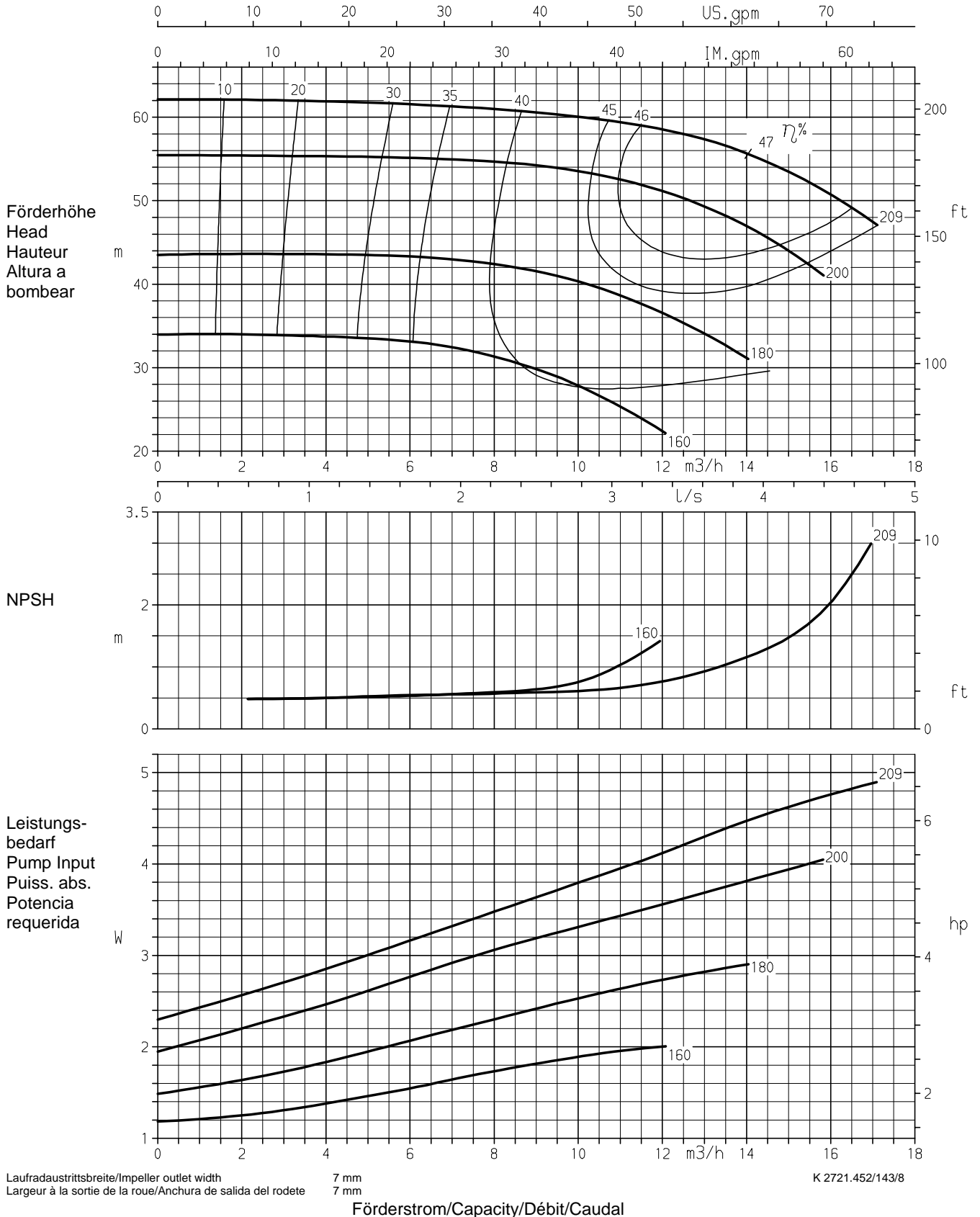

Baureihe Pump type	Modèle Tipo	Nenn Drehzahl Nom. speed	Vitesse nom. Revoluciones nom.	 KSB KSB Aktiengesellschaft Pumpen Industrie- und Wassertechnik Postfach 13 60, D-91253 Pegnitz Bahnhofplatz 1, D-91257
CPK/HPK	32-250	2900 1/min		
Angebots-Nr. Project No.	No. de l'offre Oferta-No.	Pos.-Nr. Item No.	No. de pos. No. de pos.	

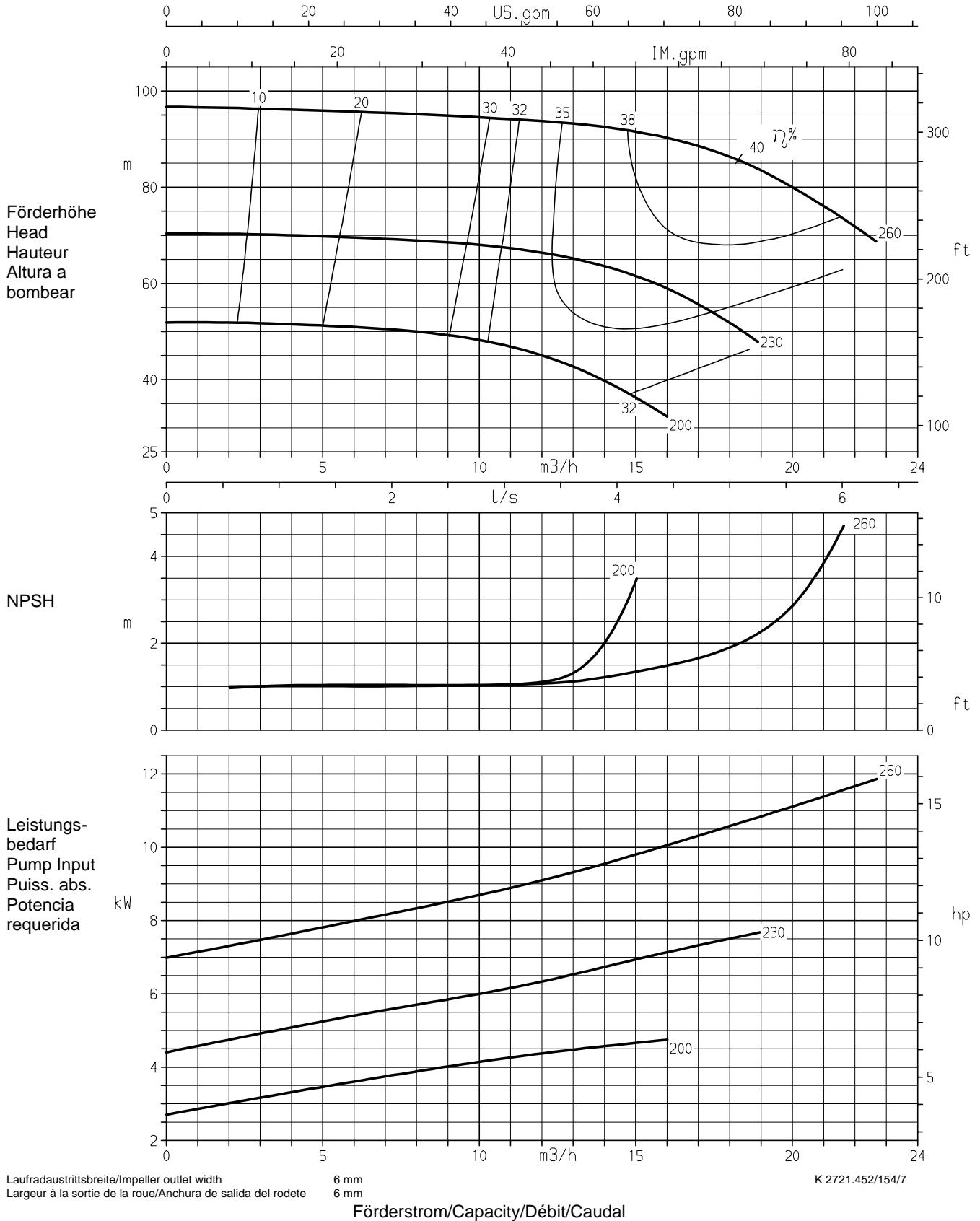

Baureihe Pump type	Modèle Tipo	Nennzahl Nom. speed	Vitesse nom. Revoluciones nom.	 KSB KSB Aktiengesellschaft Pumpen Industrie- und Wassertechnik Postfach 13 60, D-91253 Pegnitz Bahnhofplatz 1, D-91257
CPK/HPK	40-160	2900 1/min		
Angebots-Nr. Project No.	No. de l'offre Oferta-No.	Pos.-Nr. Item No.	No. de pos. No. de pos.	

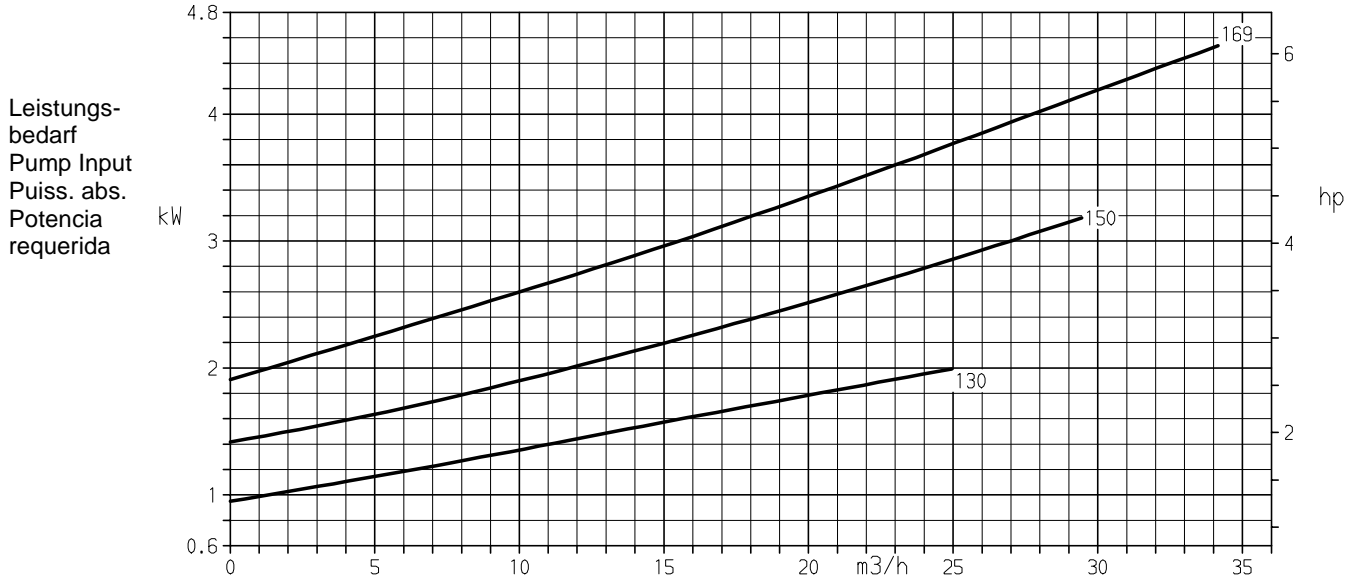
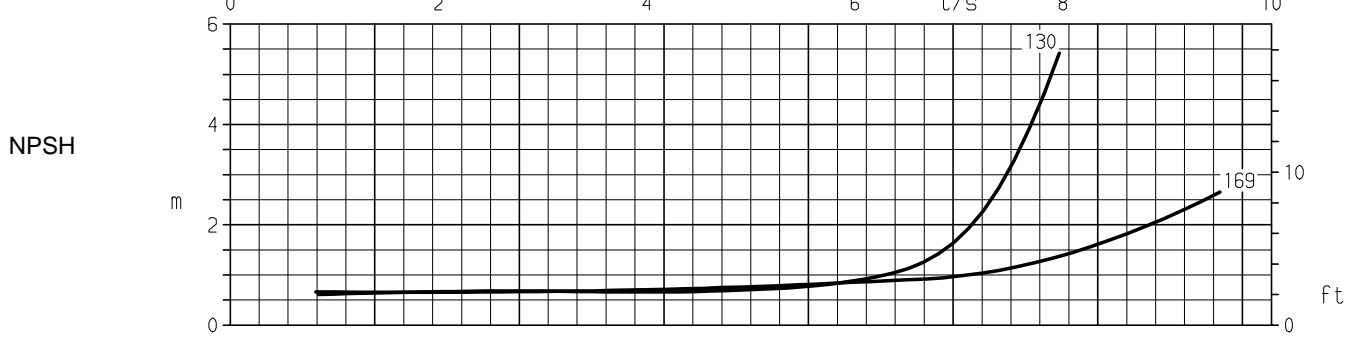
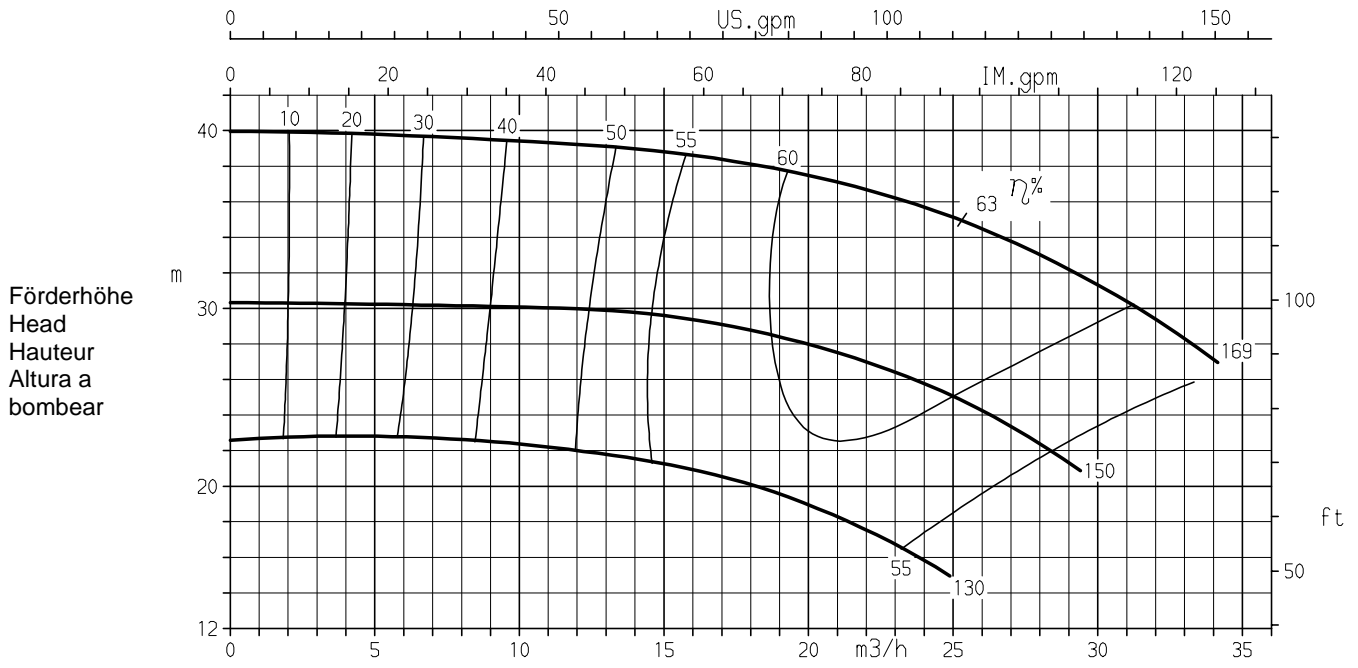



Laufradaustrittsbreite/Impeller outlet width 9 mm
 Largeur à la sortie de la roue/Anchura de salida del rodete 9 mm

Förderstrom/Capacity/Débit/Caudal

K 2721.452/182/7

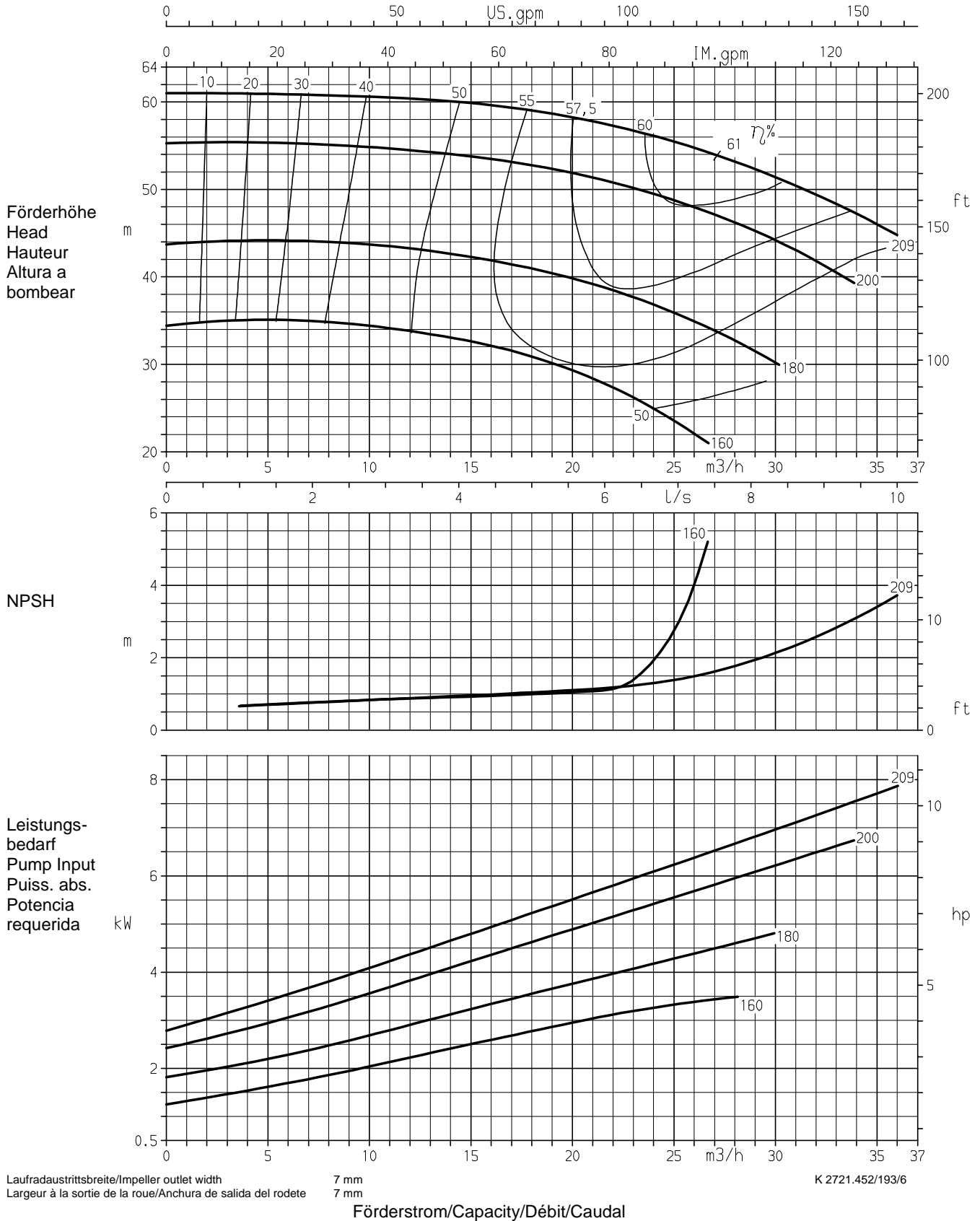
Baureihe Pump type	Modèle Tipo	Nenn Drehzahl Nom. speed	Vitesse nom. Revoluciones nom.	 KSB KSB Aktiengesellschaft Pumpen Industrie- und Wassertechnik Postfach 13 60, D-91253 Pegnitz Bahnhofplatz 1, D-91257
CPK/HPK	40-200	2900 1/min		
Angebots-Nr. Project No.	No. de l'offre Oferta-No.	Pos.-Nr. Item No.	No. de pos. No. de pos.	



Baureihe Pump type	Modèle Tipo	Nennzahl Nom. speed	Vitesse nom. Revoluciones nom.	 KSB KSB Aktiengesellschaft Pumpen Industrie- und Wassertechnik Postfach 13 60, D-91253 Pegnitz Bahnhofplatz 1, D-91257
CPK/HPK	40-250	2900 1/min		
Angebots-Nr. Project No.	No. de l'offre Oferta-No.	Pos.-Nr. Item No.	No. de pos. No. de pos.	

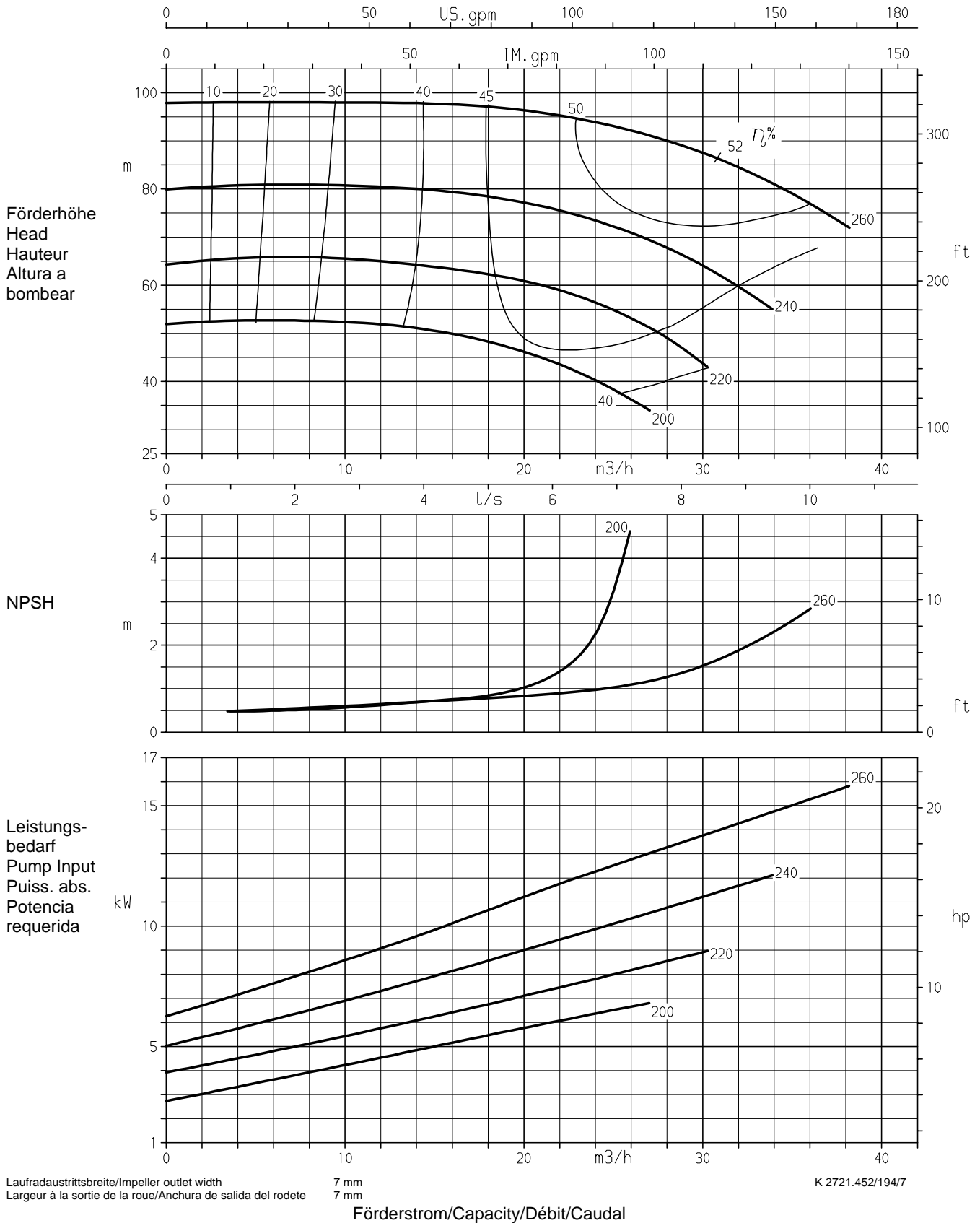

Baureihe Pump type	Modèle Tipo	Nenn Drehzahl Nom. speed	Vitesse nom. Revoluciones nom.	 KSB KSB Aktiengesellschaft Pumpen Industrie- und Wassertechnik Postfach 13 60, D-91253 Pegnitz Bahnhofplatz 1, D-91257
CPK/HPK	40-315	2900 1/min		
Angebots-Nr. Project No.	No. de l'offre Oferta-No.	Pos.-Nr. Item No.	No. de pos. No. de pos.	

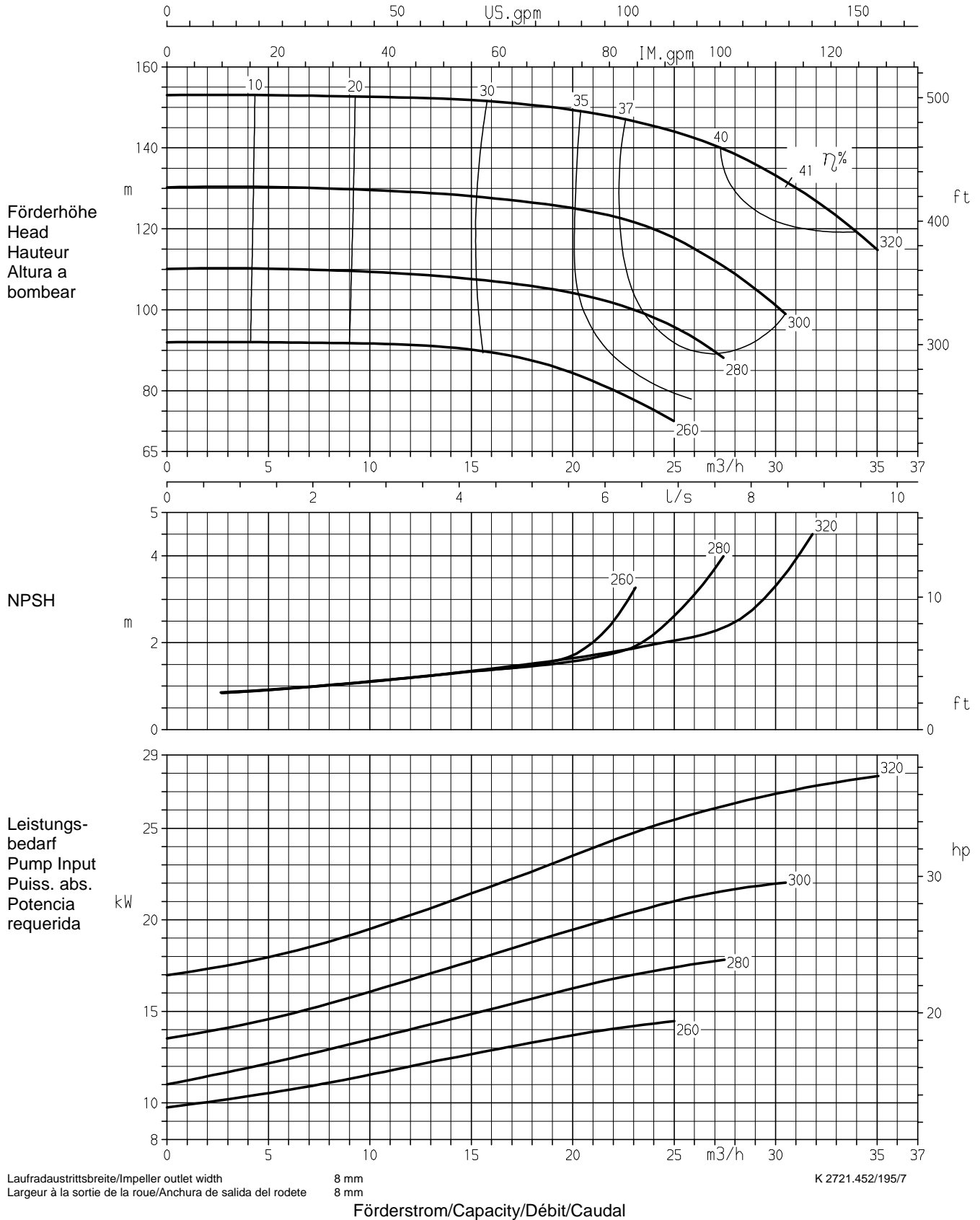

Baureihe Pump type	Modèle Tipo	Nennndrehzahl Nom. speed	Vitesse nom. Revoluciones nom.	 KSB KSB Aktiengesellschaft Pumpen Industrie- und Wassertechnik Postfach 13 60, D-91253 Pegnitz Bahnhofplatz 1, D-91257
CPK/HPK	50-160	2900 1/min		
Angebots-Nr. Project No.	No. de l'offre Oferta-No.	Pos.-Nr. Item No.	No. de pos. No. de pos.	

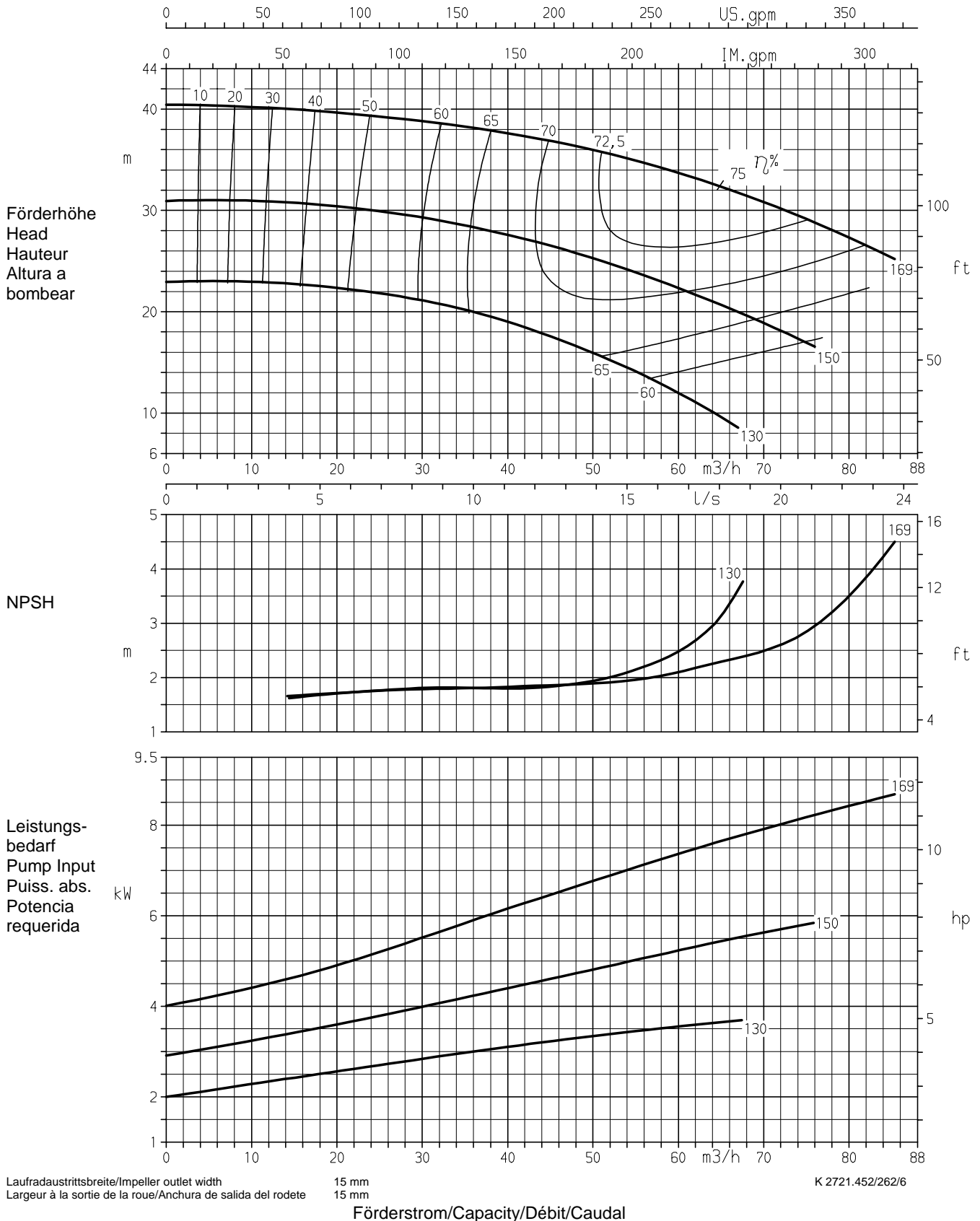

Baureihe Pump type	Modèle Tipo	Nenn Drehzahl Nom. speed	Vitesse nom. Revoluciones nom.	 KSB KSB Aktiengesellschaft Pumpen Industrie- und Wassertechnik Postfach 13 60, D-91253 Pegnitz Bahnhofplatz 1, D-91257
CPK/HPK	50-200	2900 1/min		
Angebots-Nr. Project No.	No. de l'offre Oferta-No.	Pos.-Nr. Item No.	No. de pos. No. de pos.	

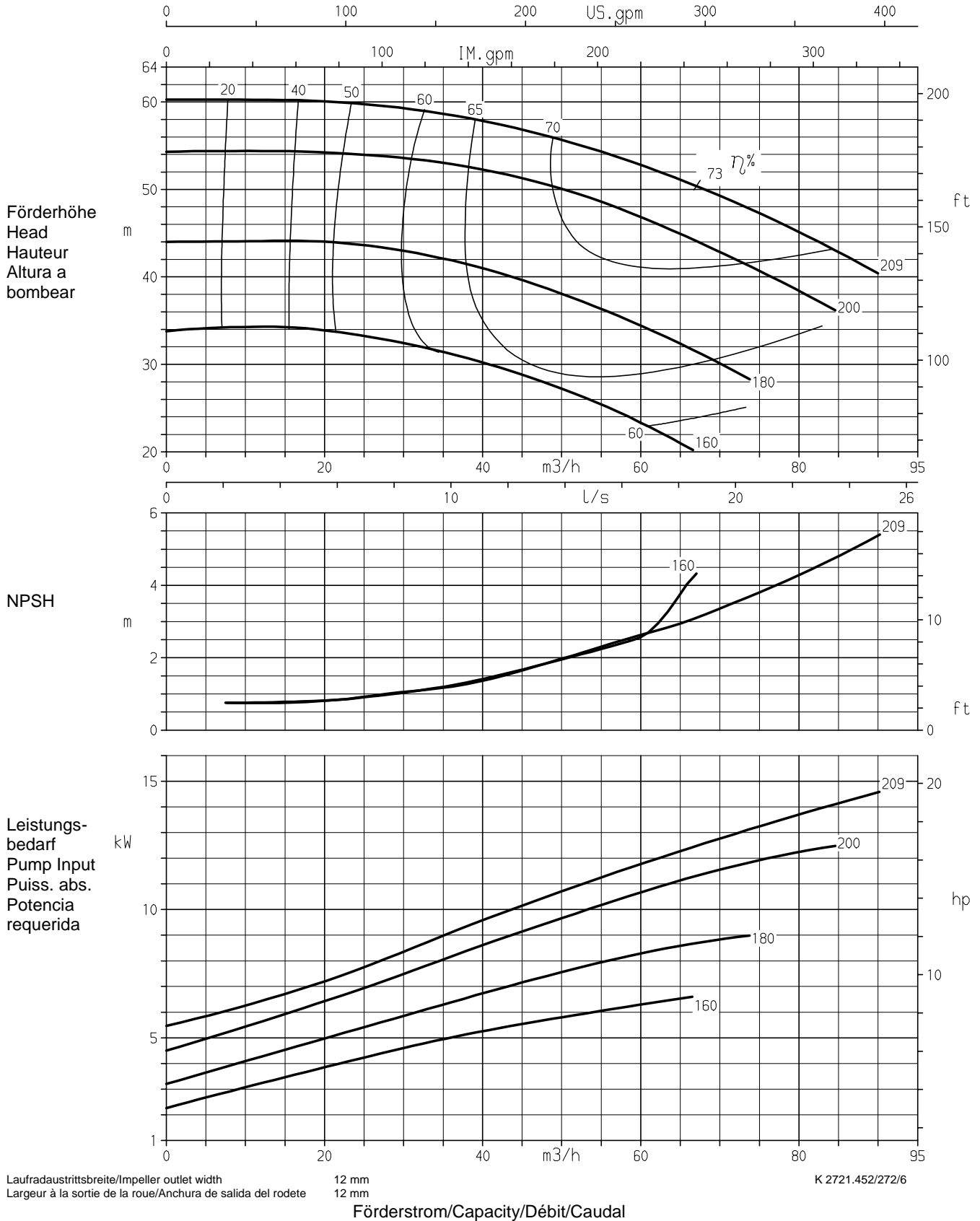

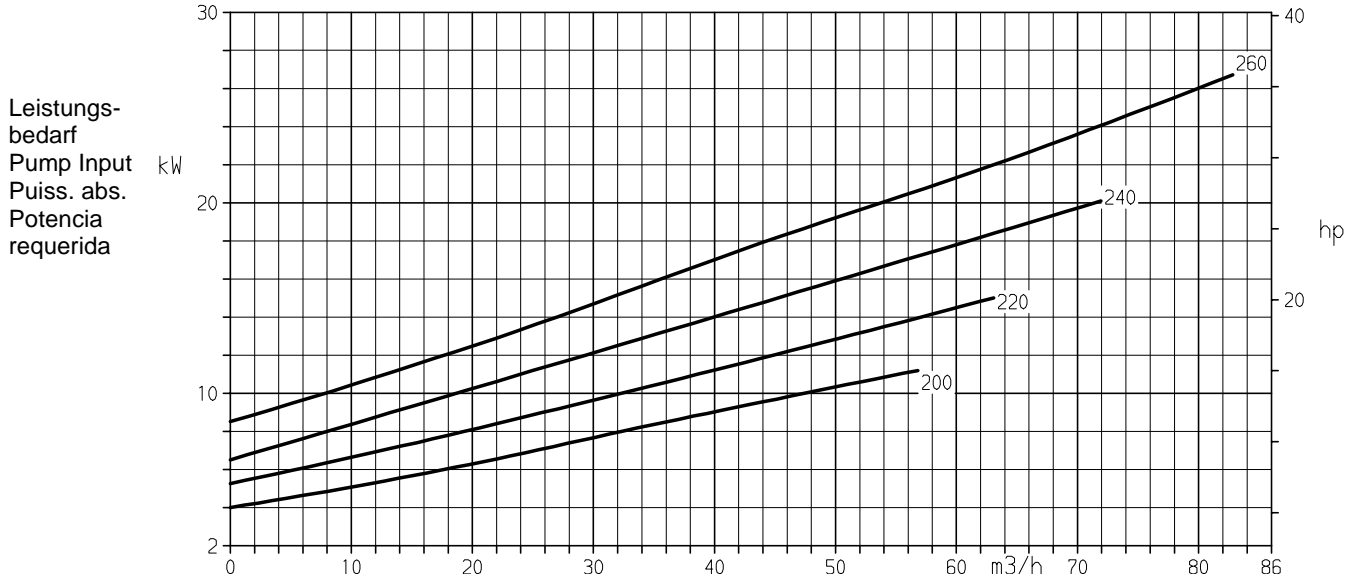
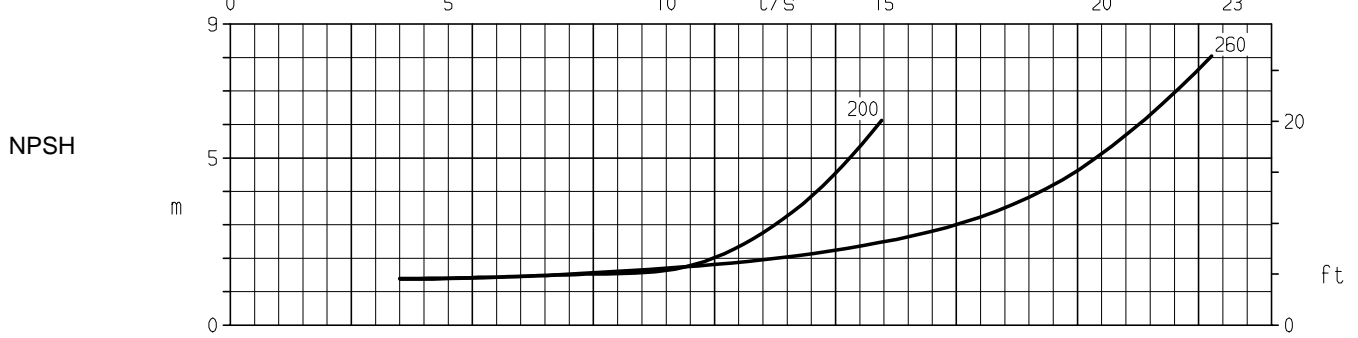
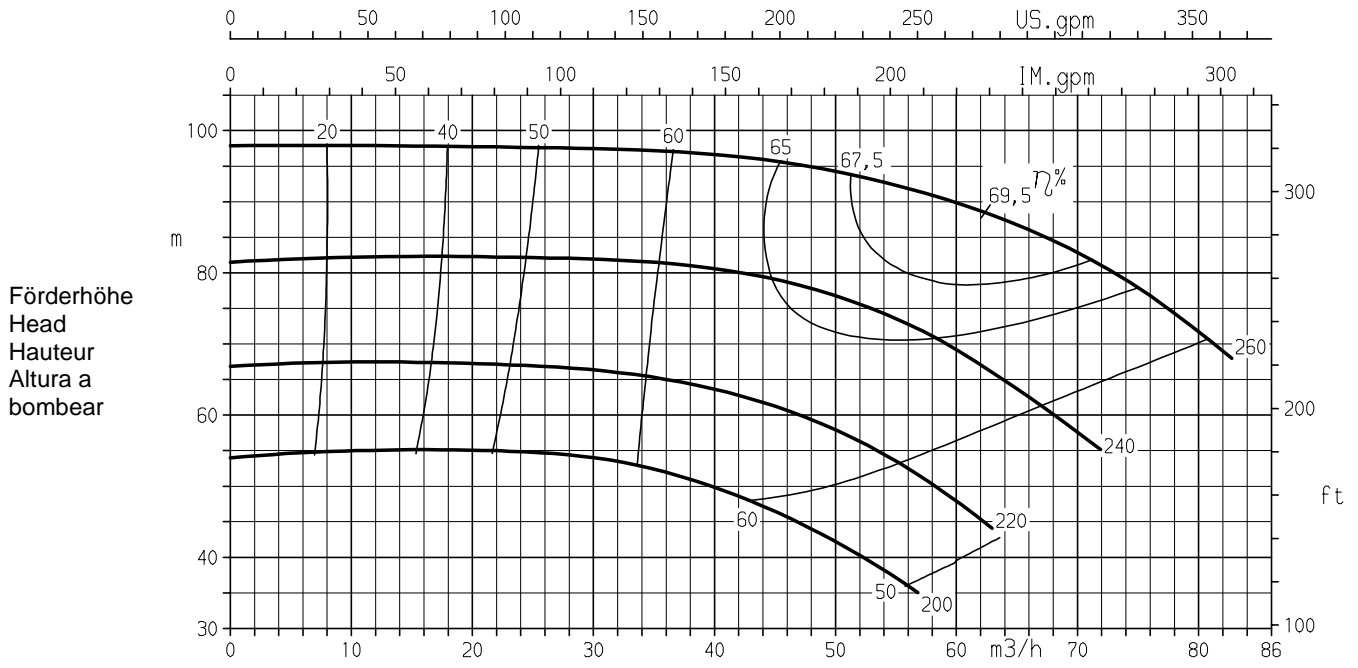

Baureihe Pump type	Modèle Tipo	Nennzahl Nom. speed	Vitesse nom. Revoluciones nom.	 KSB KSB Aktiengesellschaft Pumpen Industrie- und Wassertechnik Postfach 13 60, D-91253 Pegnitz Bahnhofplatz 1, D-91257
CPK/HPK	50-250	2900 1/min		
Angebots-Nr. Project No.	No. de l'offre Oferta-No.	Pos.-Nr. Item No.	No. de pos. No. de pos.	



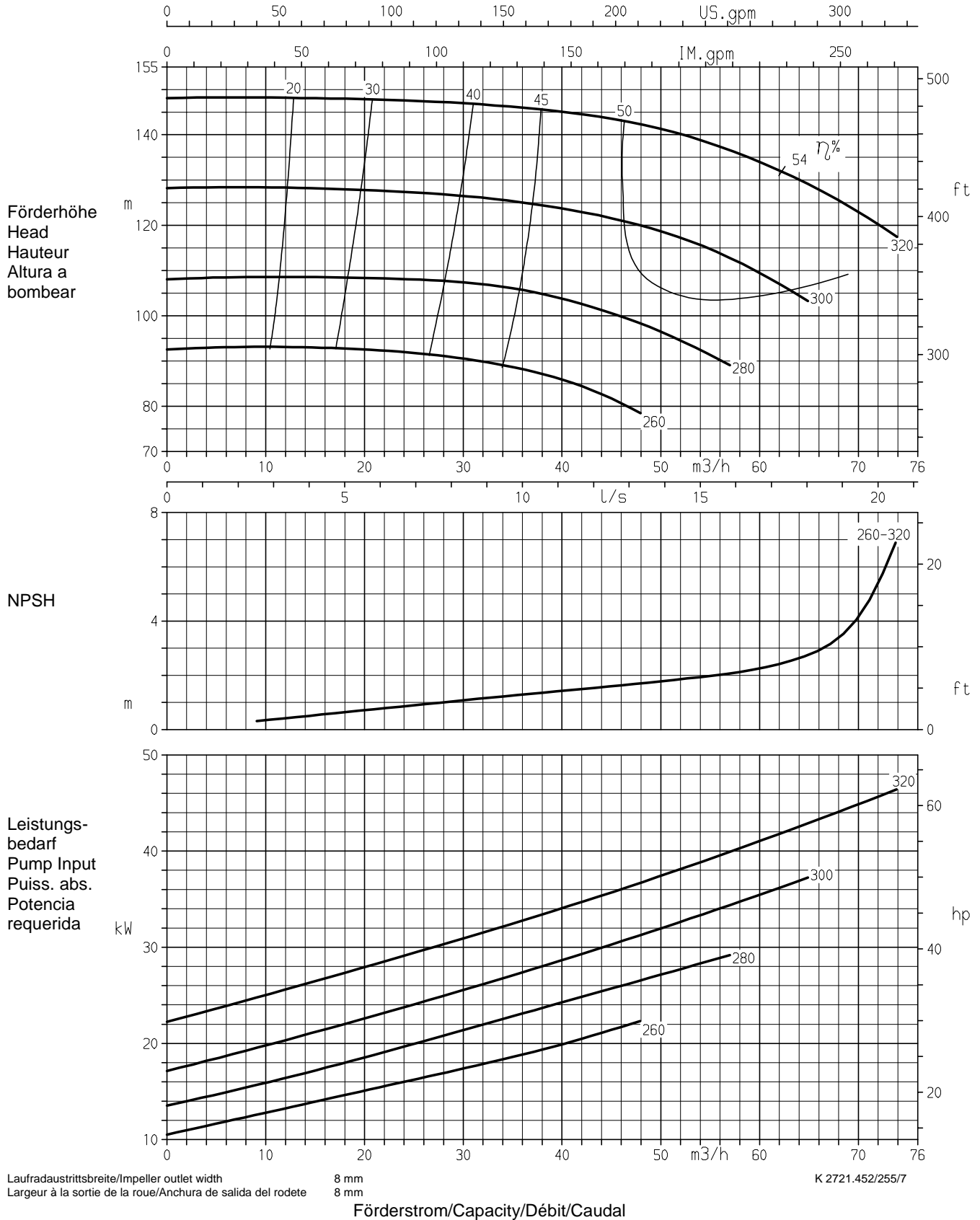

Laufradaustrittsbreite/Impeller outlet width 10 mm
 Largeur à la sortie de la roue/Anchura de salida del rodetete 10 mm
 Förderstrom/Capacity/Débit/Caudal
 K 2721.452/254/7

Baureihe Pump type	Modèle Tipo	Nenn Drehzahl Nom. speed	Vitesse nom. Revoluciones nom.	 KSB Aktiengesellschaft Pumpen Industrie- und Wassertechnik Postfach 13 60, D-91253 Pegnitz Bahnhofplatz 1, D-91257
CPK/HPK	50-315	2900 1/min		
Angebots-Nr. Project No.	No. de l'offre Oferta-No.	Pos.-Nr. Item No.	No. de pos. No. de pos.	

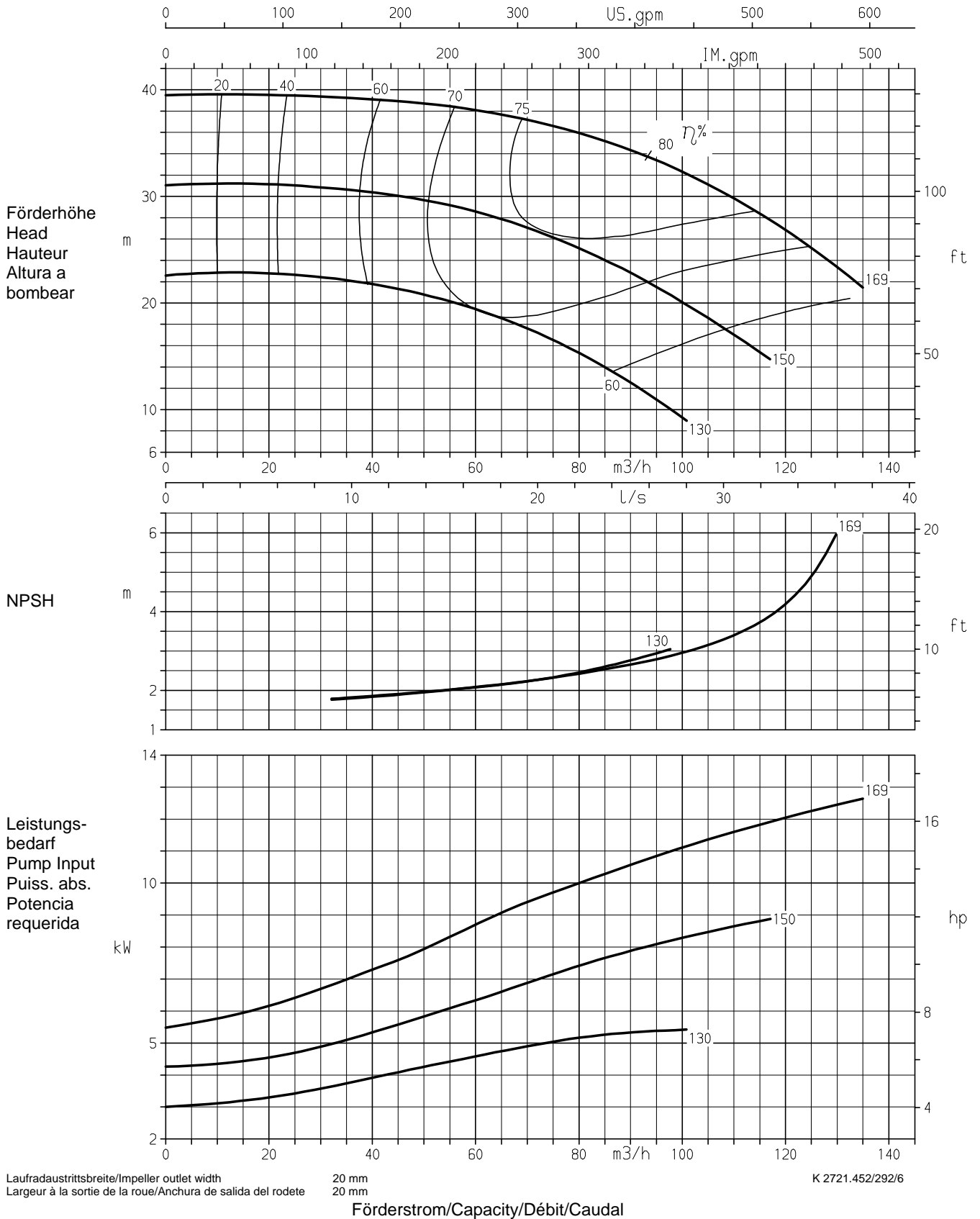

Baureihe Pump type	Modèle Tipo	Nenn Drehzahl Nom. speed	Vitesse nom. Revoluciones nom.	 KSB KSB Aktiengesellschaft Pumpen Industrie- und Wassertechnik Postfach 13 60, D-91253 Pegnitz Bahnhofplatz 1, D-91257
CPK/HPK	65-160	2900 1/min		
Angebots-Nr. Project No.	No. de l'offre Oferta-No.	Pos.-Nr. Item No.	No. de pos. No. de pos.	



Baureihe Pump type	Modèle Tipo	Nenn Drehzahl Nom. speed	Vitesse nom. Revoluciones nom.	 KSB KSB Aktiengesellschaft Pumpen Industrie- und Wassertechnik Postfach 13 60, D-91253 Pegnitz Bahnhofplatz 1, D-91257
CPK/HPK	65-200	2900 1/min		
Angebots-Nr. Project No.	No. de l'offre Oferta-No.	Pos.-Nr. Item No.	No. de pos. No. de pos.	

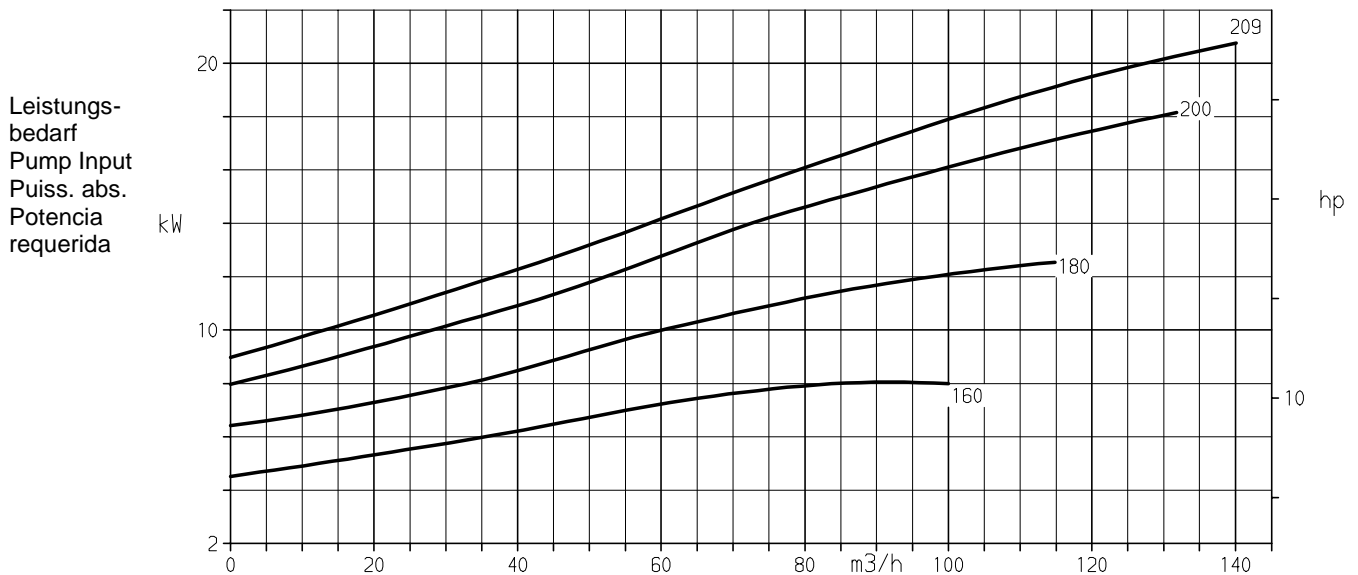
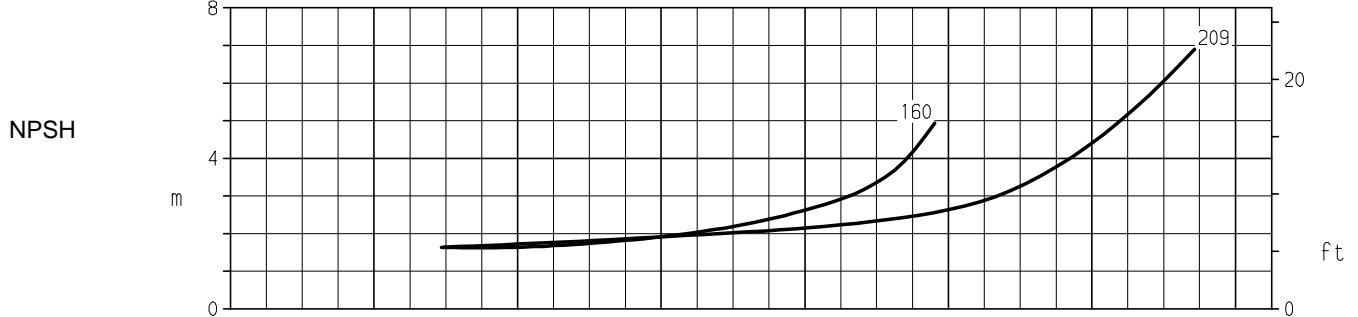
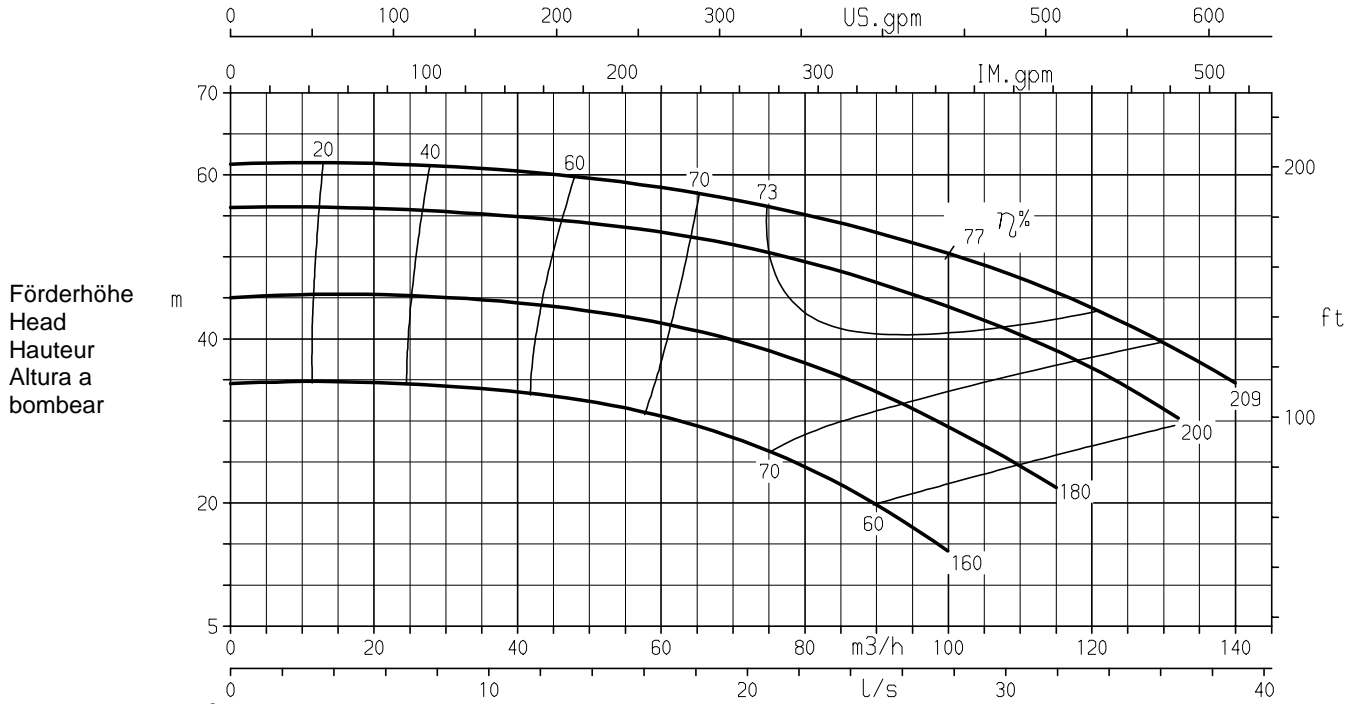

Laufraudaustrittsbreite/Impeller outlet width
Largeur à la sortie de la roue/Anchura de salida del rodete

16 mm
16 mm

K 2721.452/303/7

Förderstrom/Capacity/Débit/Caudal

Baureihe Pump type	Modèle Tipo	Nenn Drehzahl Nom. speed	Vitesse nom. Revoluciones nom.	 KSB KSB Aktiengesellschaft Pumpen Industrie- und Wassertechnik Postfach 13 60, D-91253 Pegnitz Bahnhofplatz 1, D-91257
CPK/HPK	65-250	2900 1/min		
Angebots-Nr. Project No.	No. de l'offre Oferta-No.	Pos.-Nr. Item No.	No. de pos. No. de pos.	

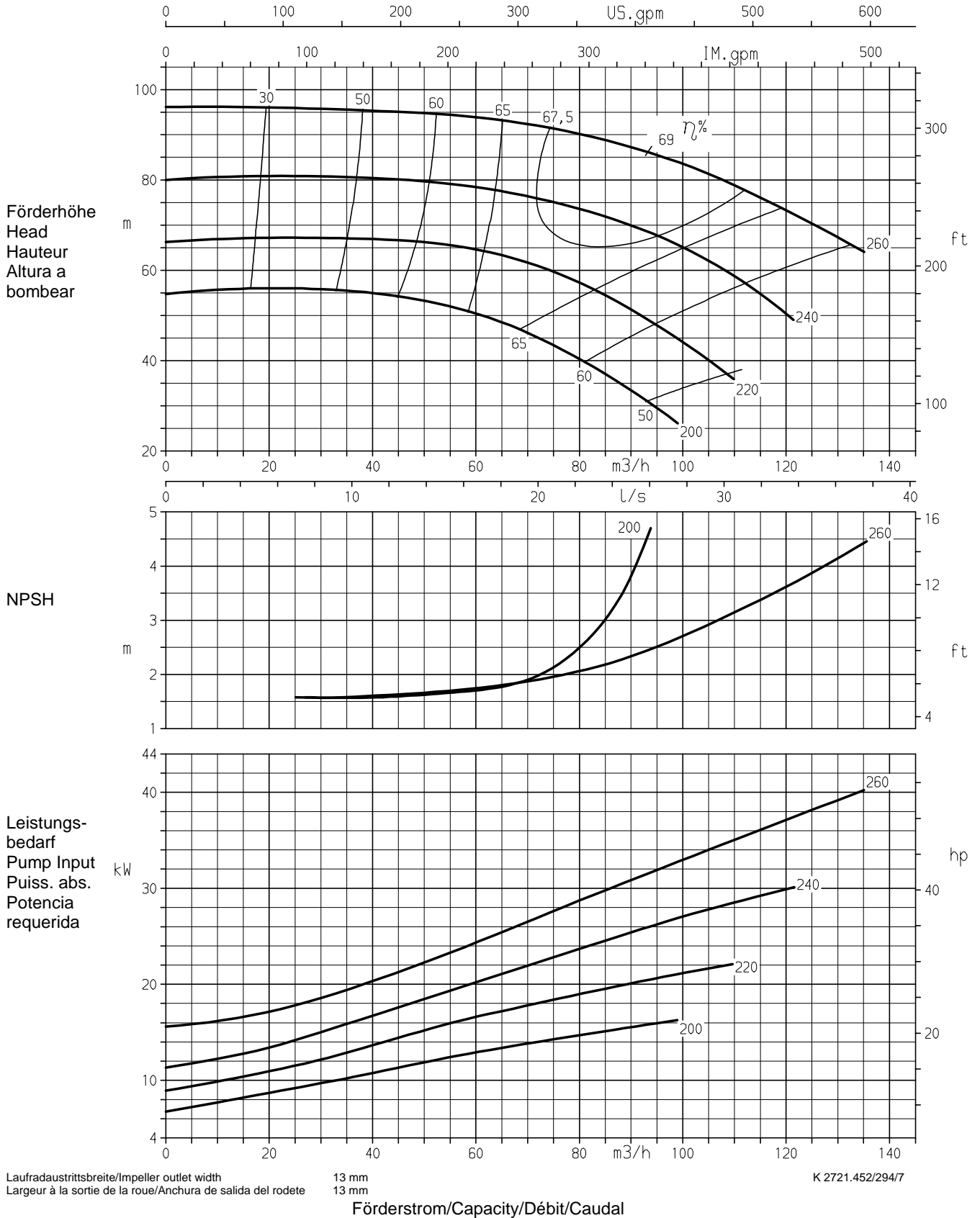

Baureihe Pump type	Modèle Tipo	Nenn Drehzahl Nom. speed	Vitesse nom. Revoluciones nom.	 KSB KSB Aktiengesellschaft Pumpen Industrie- und Wassertechnik Postfach 13 60, D-91253 Pegnitz Bahnhofplatz 1, D-91257
CPK/HPK	65-315	2900 1/min		
Angebots-Nr. Project No.	No. de l'offre Oferta-No.	Pos.-Nr. Item No.	No. de pos. No. de pos.	

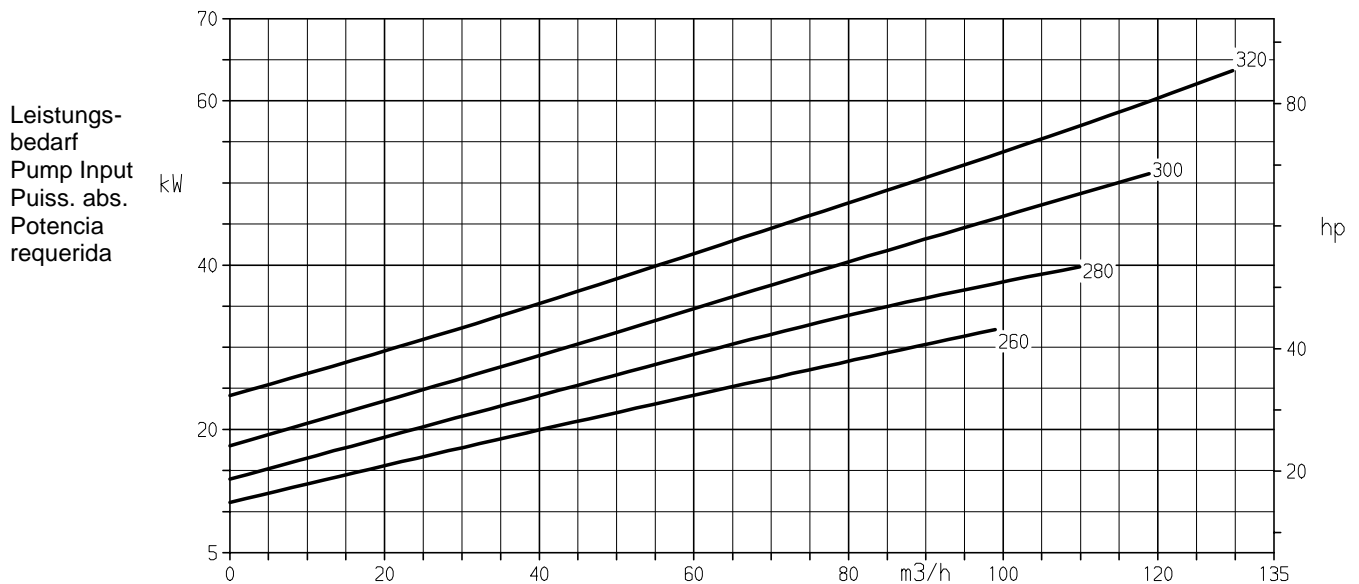
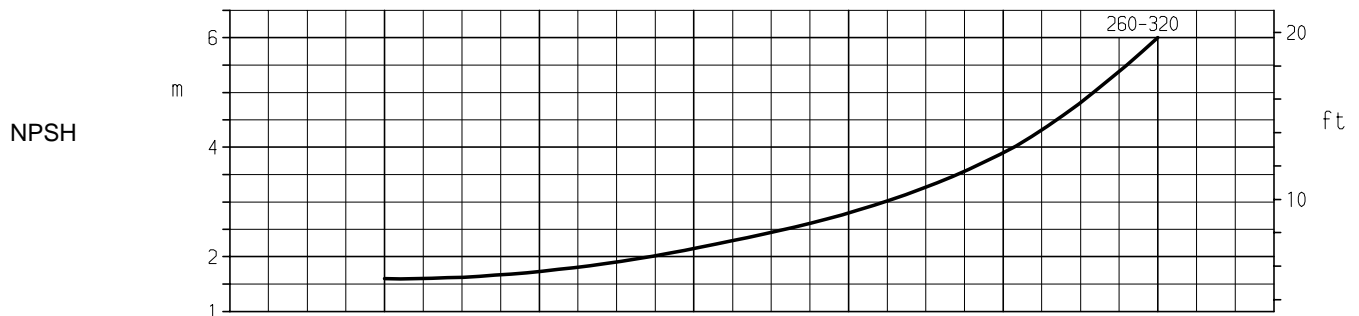
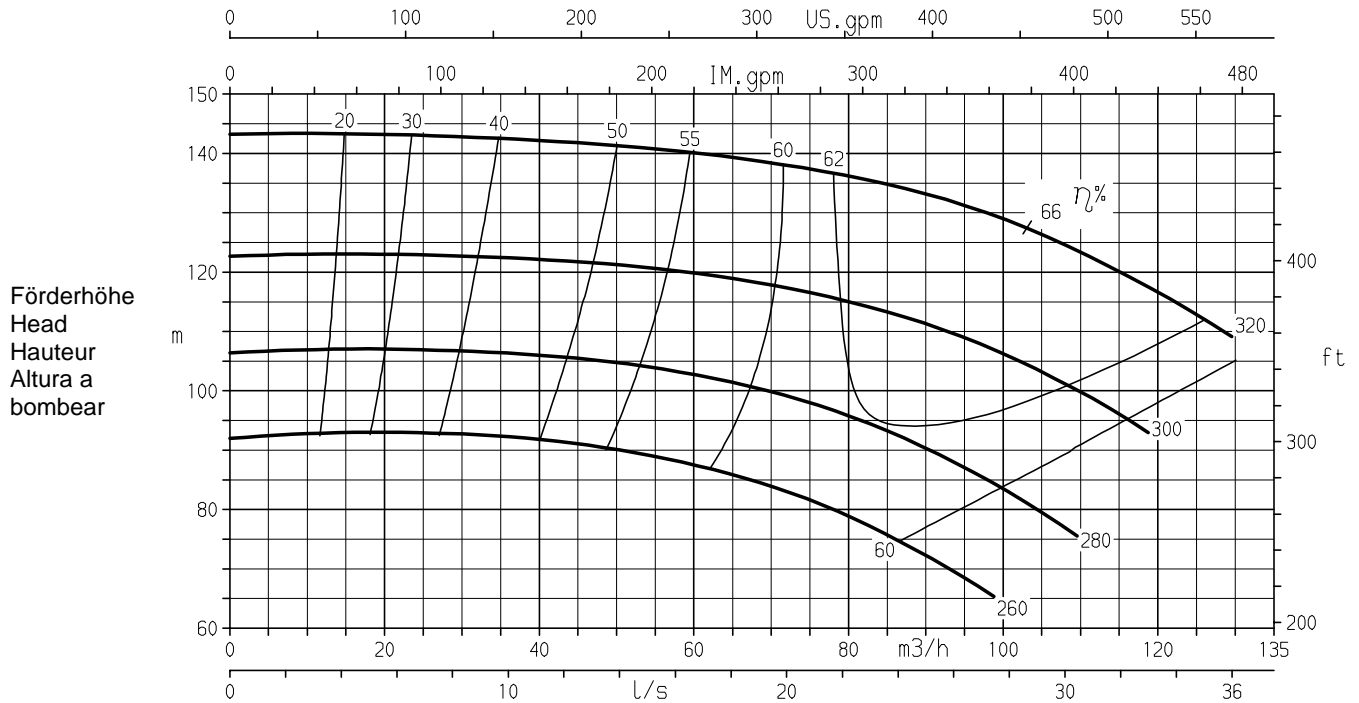

Laufraudaustrittsweite/Impeller outlet width
Largeur à la sortie de la roue/Anchura de salida del rodete

10 mm
10 mm

K 2721.452/295/8

Förderstrom/Capacity/Débit/Caudal

Baureihe Pump type	Modèle Tipo	Nenn Drehzahl Nom. speed	Vitesse nom. Revoluciones nom.	 KSB KSB Aktiengesellschaft Pumpen Industrie- und Wassertechnik Postfach 13 60, D-91253 Pegnitz Bahnhofplatz 1, D-91257
CPK/HPK	80-160	2900 1/min		
Angebots-Nr. Project No.	No. de l'offre Oferta-No.	Pos.-Nr. Item No.	No. de pos. No. de pos.	

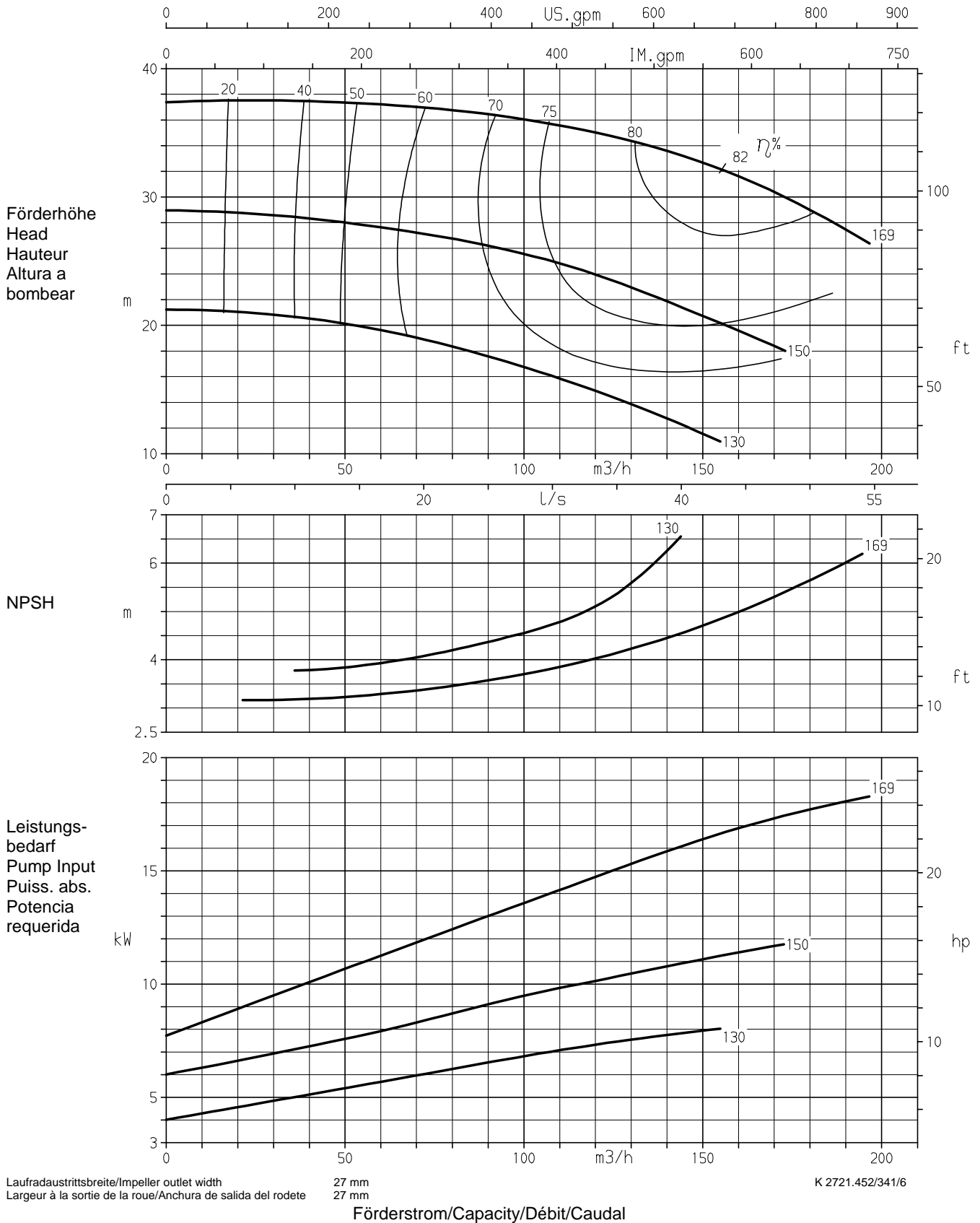

Baureihe Pump type	Modèle Tipo	Nenn Drehzahl Nom. speed	Vitesse nom. Revoluciones nom.	 KSB KSB Aktiengesellschaft Pumpen Industrie- und Wassertechnik Postfach 13 60, D-91253 Pegnitz Bahnhofplatz 1, D-91257
CPK/HPK	80-200	2900 1/min		
Angebots-Nr. Project No.	No. de l'offre Oferta-No.	Pos.-Nr. Item No.	No. de pos. No. de pos.	

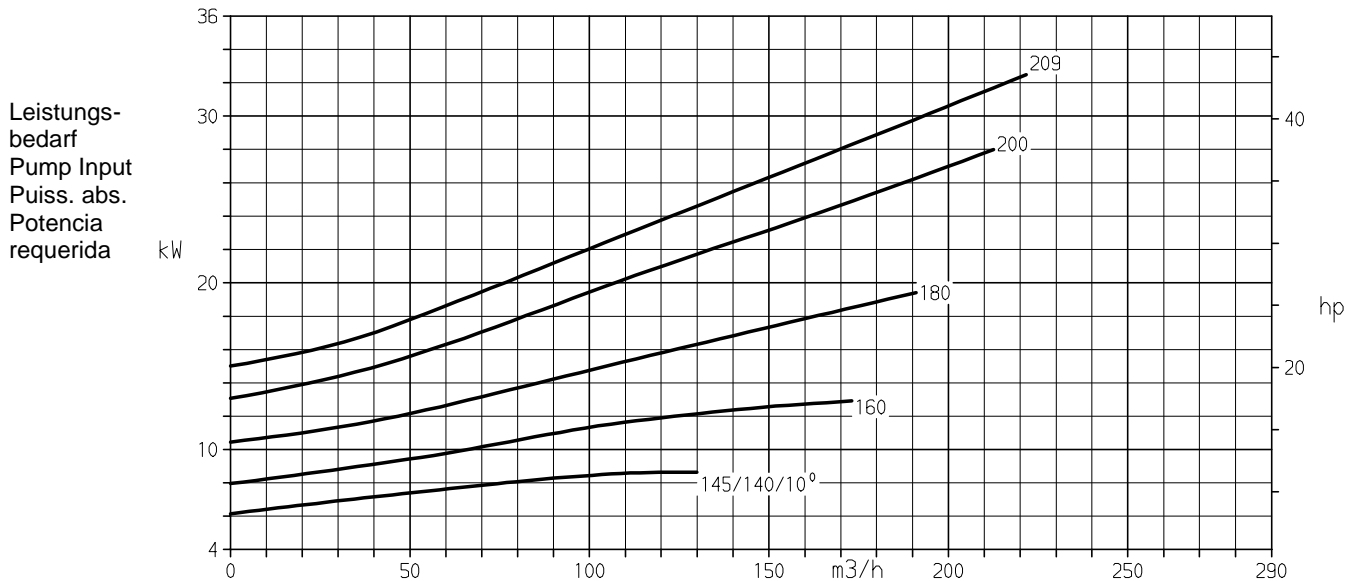
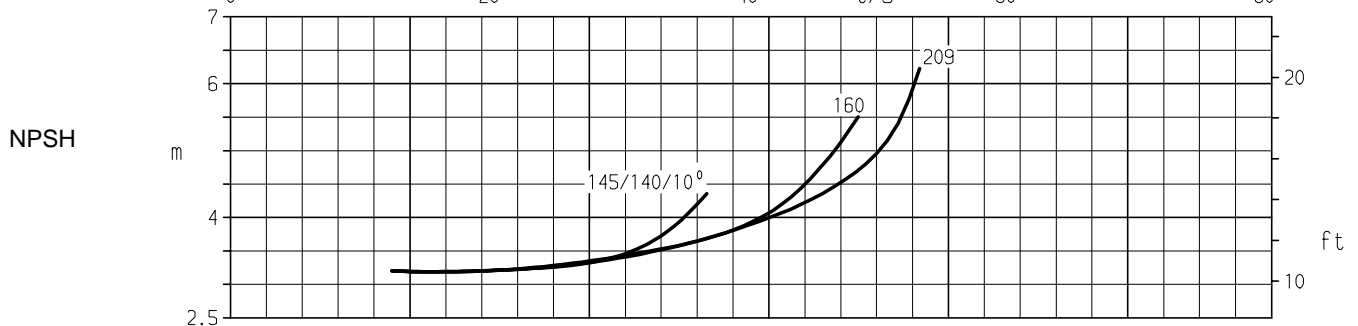
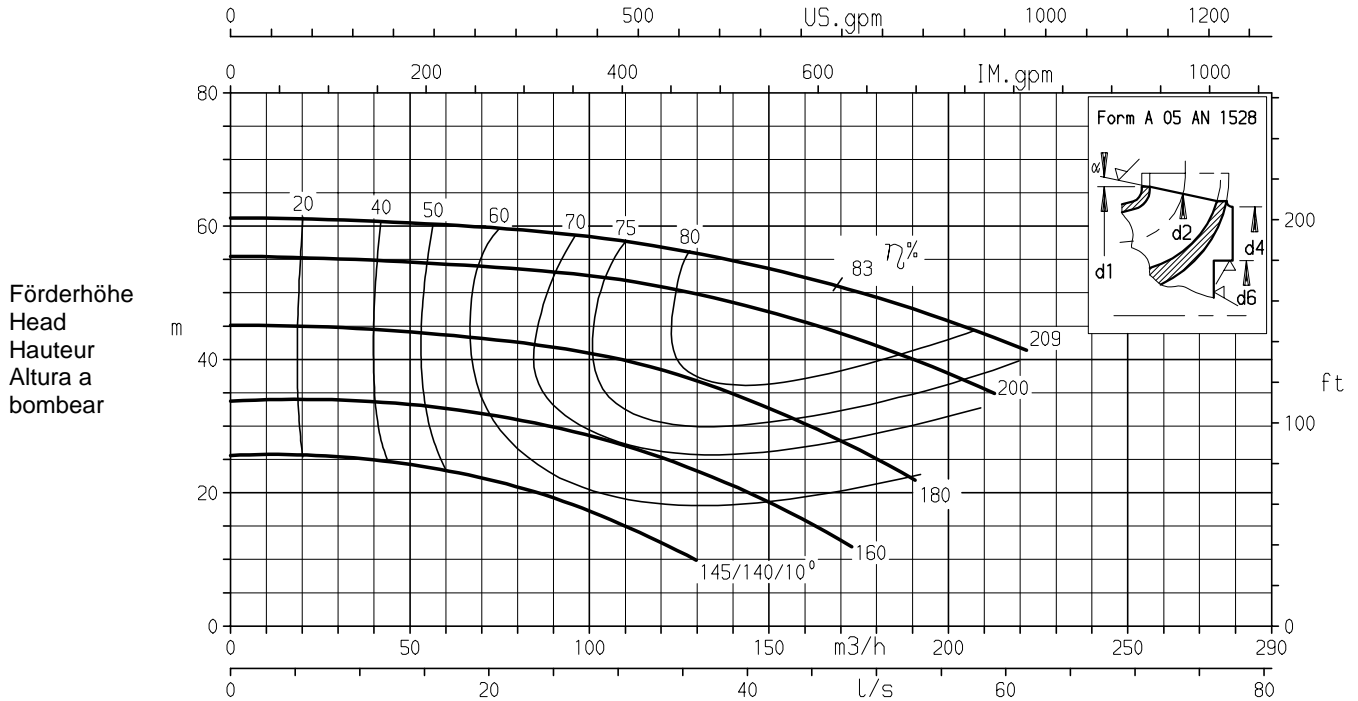

Laufraudaustrittsweite/Impeller outlet width
Largeur à la sortie de la roue/Anchura de salida del rodete

22 mm
22 mm

K 2721.452/352/7

Förderstrom/Capacity/Débit/Caudal

Baureihe Pump type	Modèle Tipo	Nenn Drehzahl Nom. speed	Vitesse nom. Revoluciones nom.	 KSB KSB Aktiengesellschaft Pumpen Industrie- und Wassertechnik Postfach 13 60, D-91253 Pegnitz Bahnhofplatz 1, D-91257
CPK/HPK	80-250	2900 1/min		
Angebots-Nr. Project No.	No. de l'offre Oferta-No.	Pos.-Nr. Item No.	No. de pos. No. de pos.	

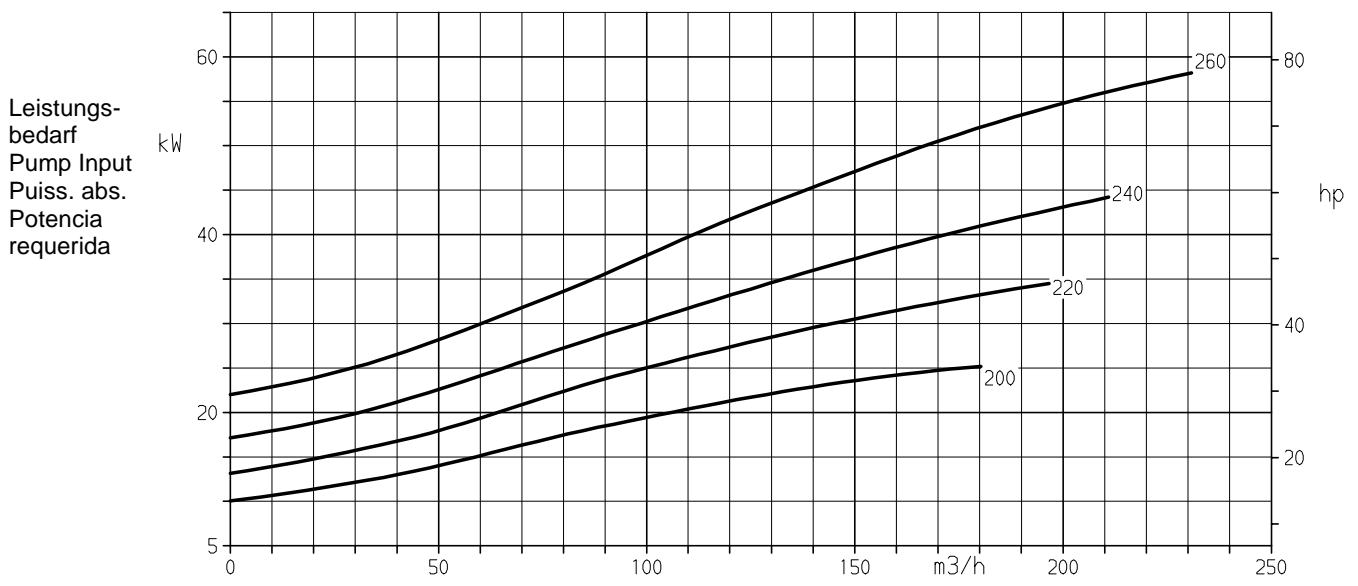
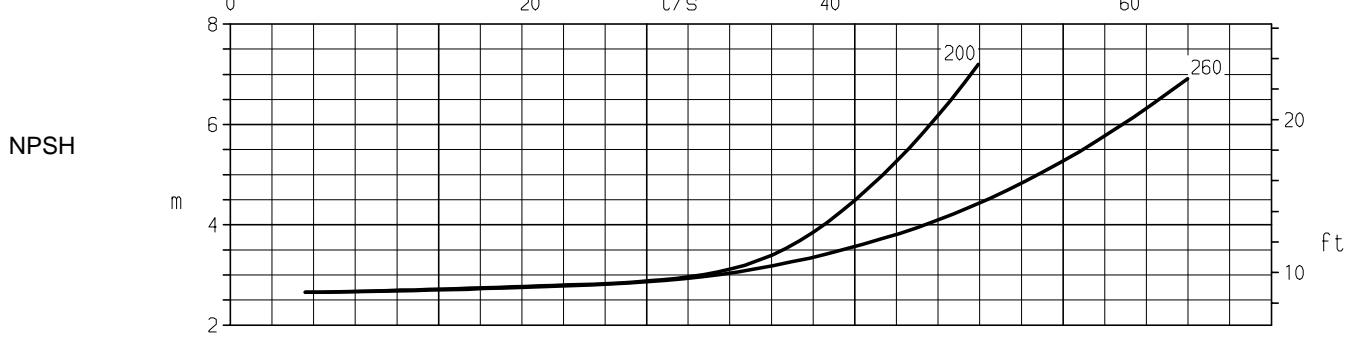
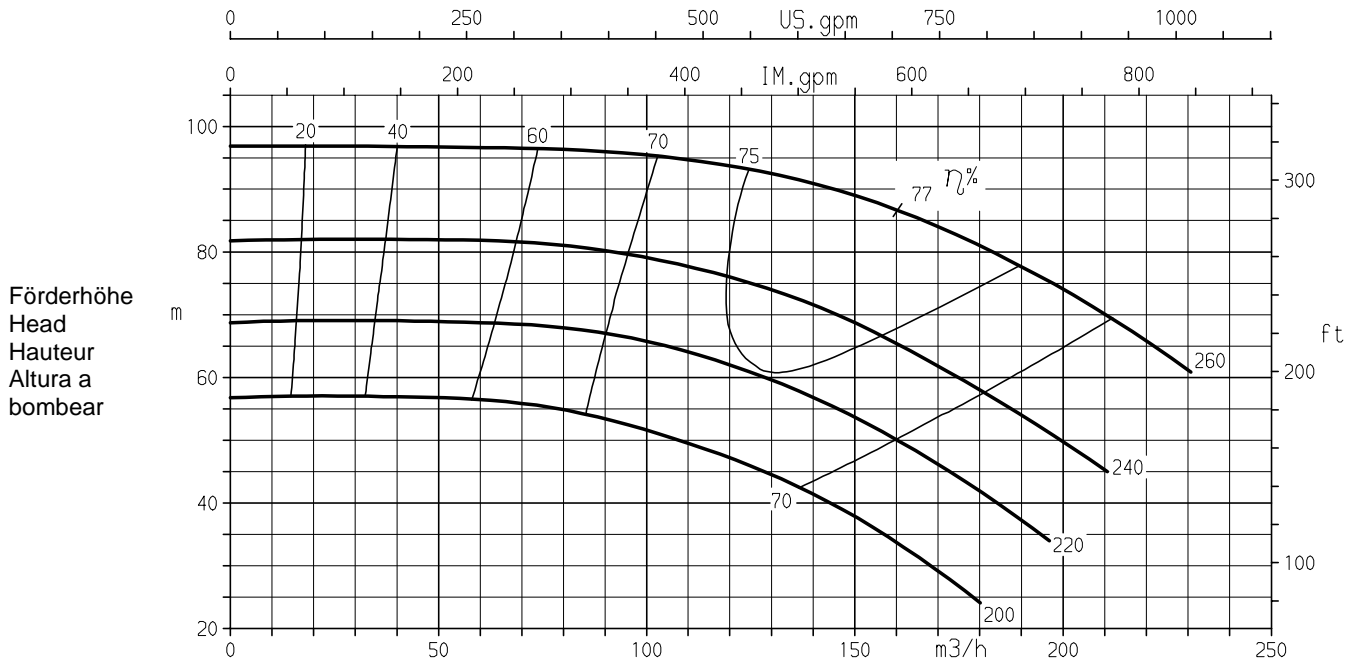

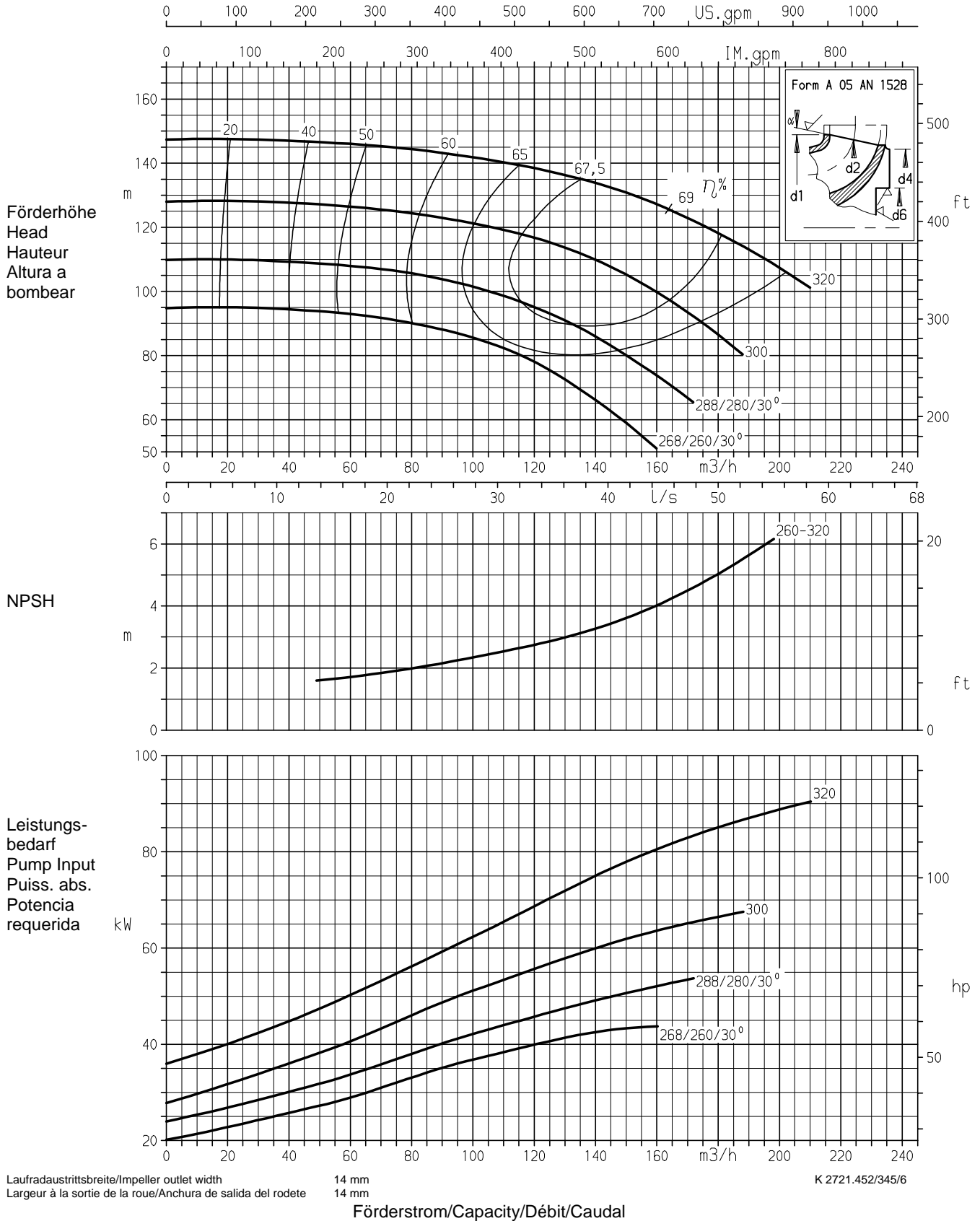

Laufradaustrittsbreite/Impeller outlet width 17 mm
 Largeur à la sortie de la roue/Anchura de salida del rodete 17 mm
 Förderstrom/Capacity/Débit/Caudal
 K 2721.452/354/6

Baureihe Pump type	Modèle Tipo	Nenn Drehzahl Nom. speed	Vitesse nom. Revoluciones nom.	 KSB KSB Aktiengesellschaft Pumpen Industrie- und Wassertechnik Postfach 13 60, D-91253 Pegnitz Bahnhofplatz 1, D-91257
CPK/HPK	80-315	2900 1/min		
Angebots-Nr. Project No.	No. de l'offre Oferta-No.	Pos.-Nr. Item No.	No. de pos. No. de pos.	

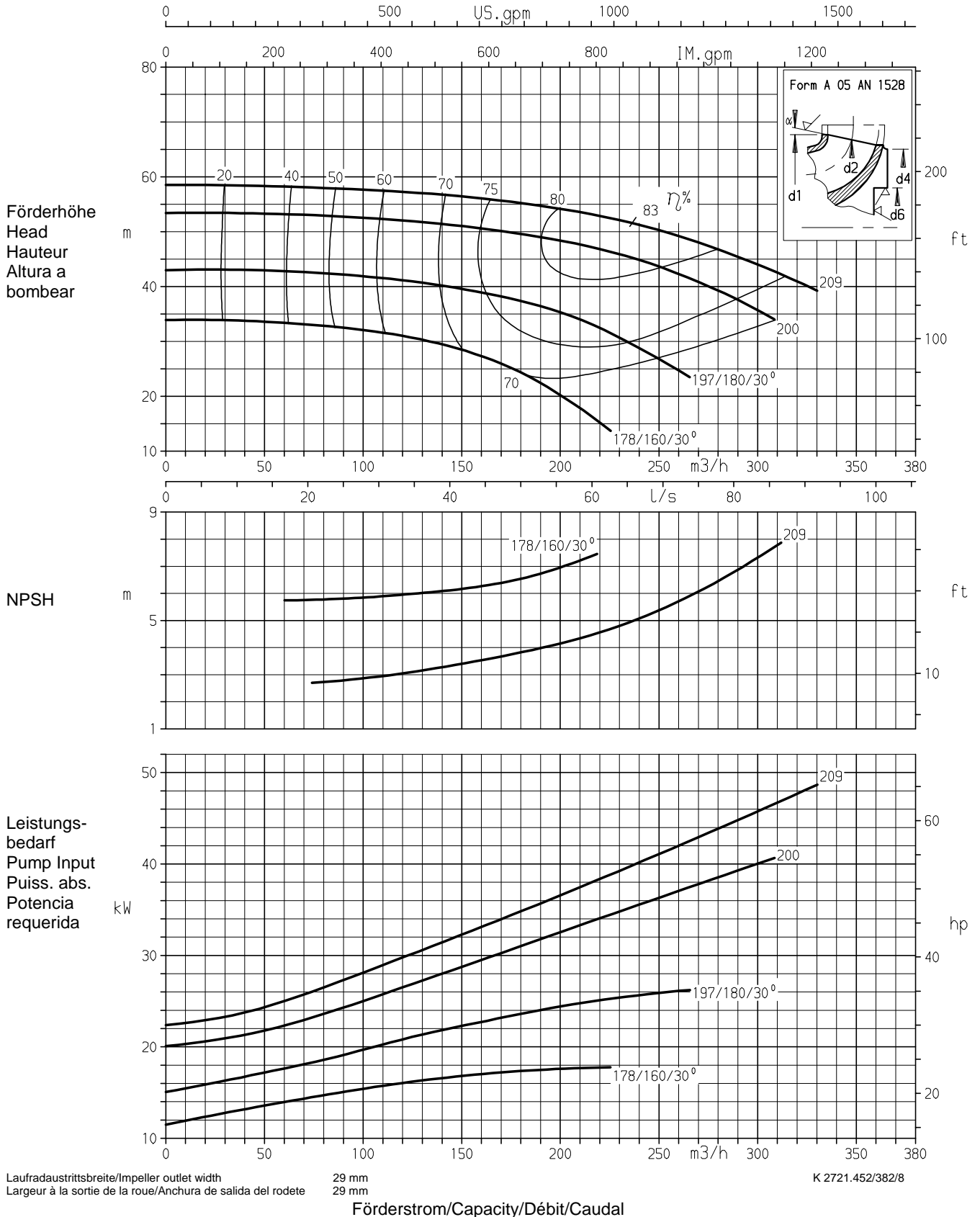

Baureihe Pump type	Modèle Tipo	Nennzahl Nom. speed	Vitesse nom. Revoluciones nom.	 KSB KSB Aktiengesellschaft Pumpen Industrie- und Wassertechnik Postfach 13 60, D-91253 Pegnitz Bahnhofplatz 1, D-91257
CPK/HPK	100-200	2900 1/min		
Angebots-Nr. Project No.	No. de l'offre Oferta-No.	Pos.-Nr. Item No.	No. de pos. No. de pos.	



Baureihe Pump type	Modèle Tipo	Nenn Drehzahl Nom. speed	Vitesse nom. Revoluciones nom.	 KSB KSB Aktiengesellschaft Pumpen Industrie- und Wassertechnik Postfach 13 60, D-91253 Pegnitz Bahnhofplatz 1, D-91257
CPK/HPK	100-250	2900 1/min		
Angebots-Nr. Project No.	No. de l'offre Oferta-No.	Pos.-Nr. Item No.	No. de pos. No. de pos.	

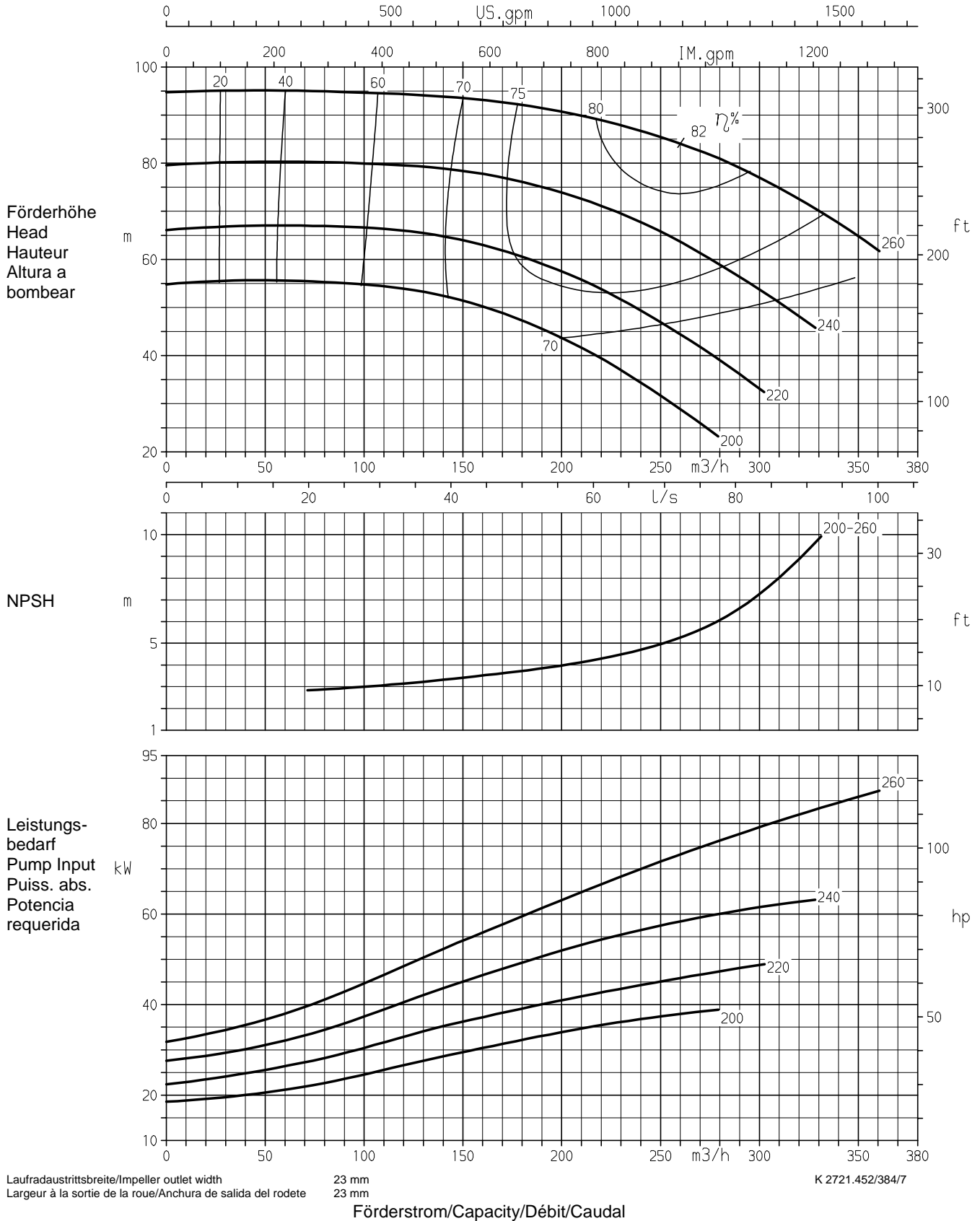

Baureihe Pump type	Modèle Tipo	Nennzahl Nom. speed	Vitesse nom. Revoluciones nom.	 KSB KSB Aktiengesellschaft Pumpen Industrie- und Wassertechnik Postfach 13 60, D-91253 Pegnitz Bahnhofplatz 1, D-91257
CPK/HPK	100-315	2900 1/min		
Angebots-Nr. Project No.	No. de l'offre Oferta-No.	Pos.-Nr. Item No.	No. de pos. No. de pos.	

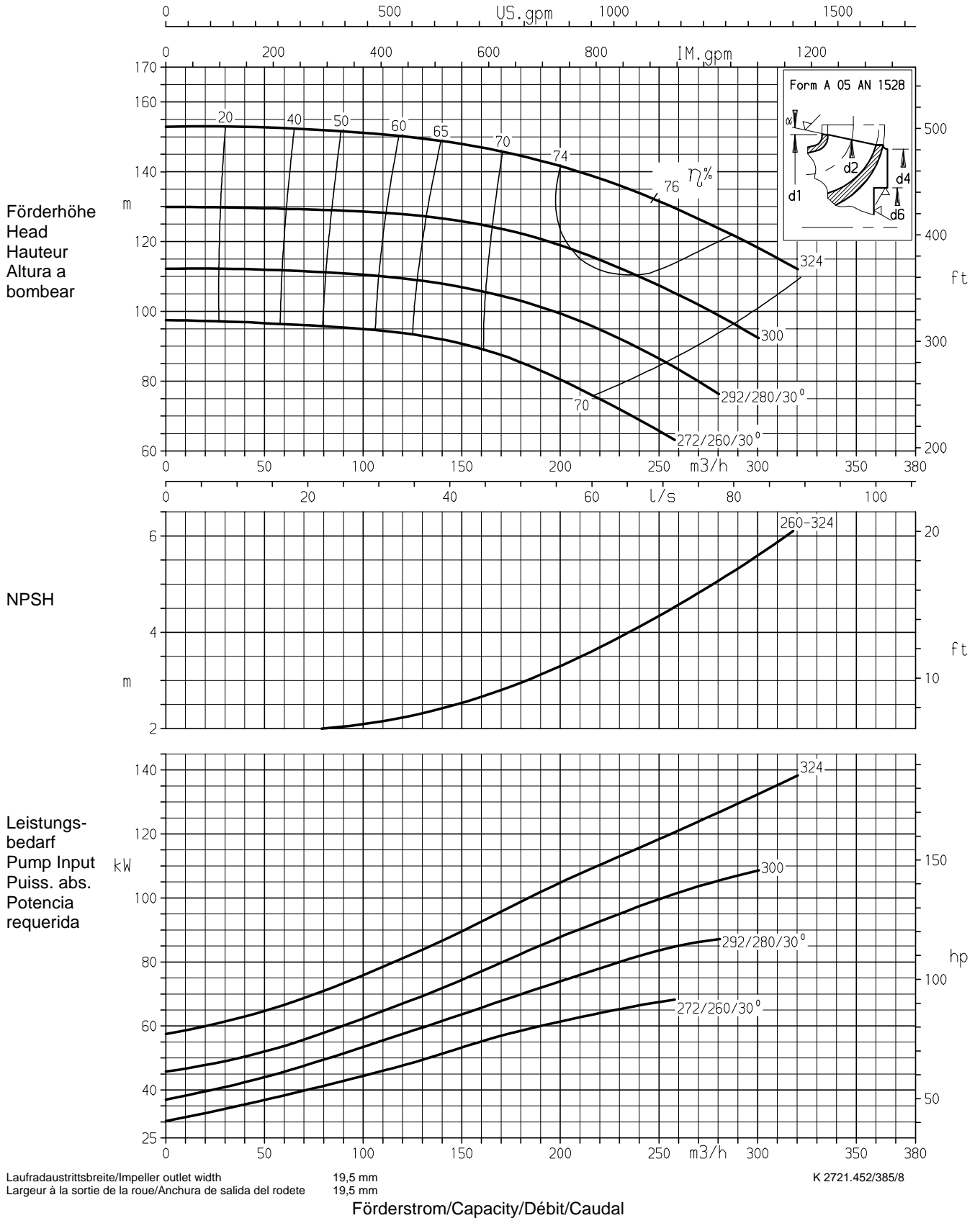

Baureihe Pump type	Modèle Tipo	Nenn Drehzahl Nom. speed	Vitesse nom. Revoluciones nom.	 KSB KSB Aktiengesellschaft Pumpen Industrie- und Wassertechnik Postfach 13 60, D-91253 Pegnitz Bahnhofplatz 1, D-91257
CPK/HPK	25-160	1450 1/min		
Angebots-Nr. Project No.	No. de l'offre Oferta-No.	Pos.-Nr. Item No.	No. de pos. No. de pos.	

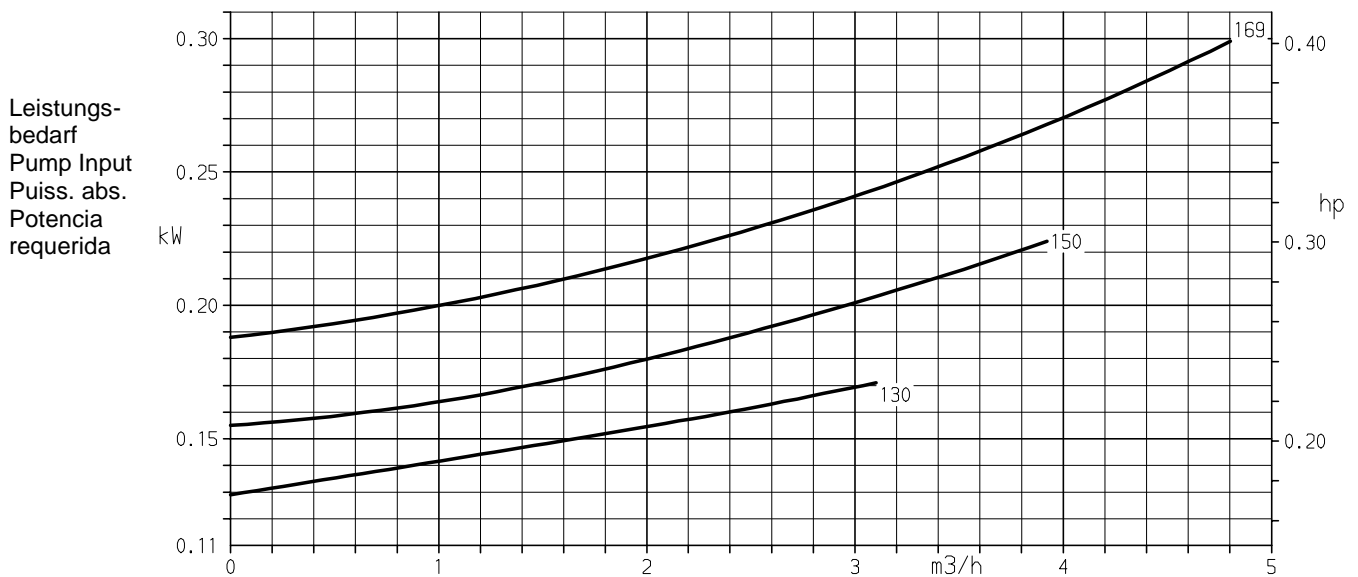
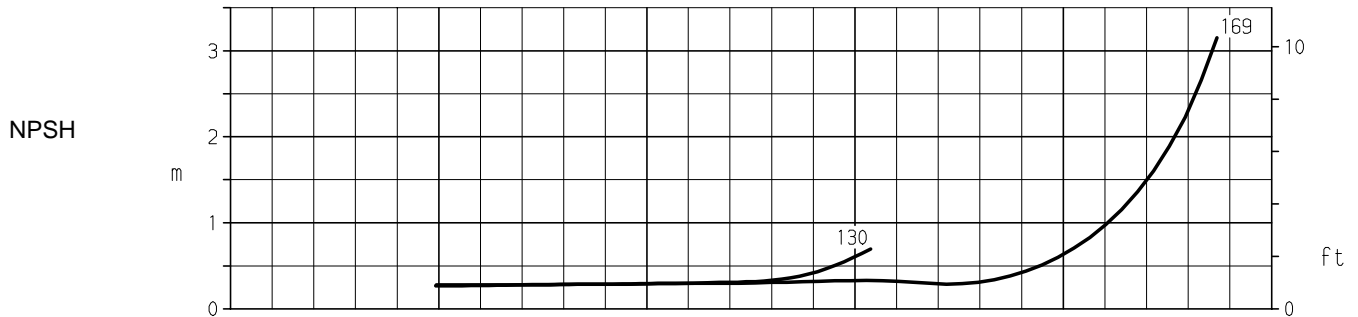
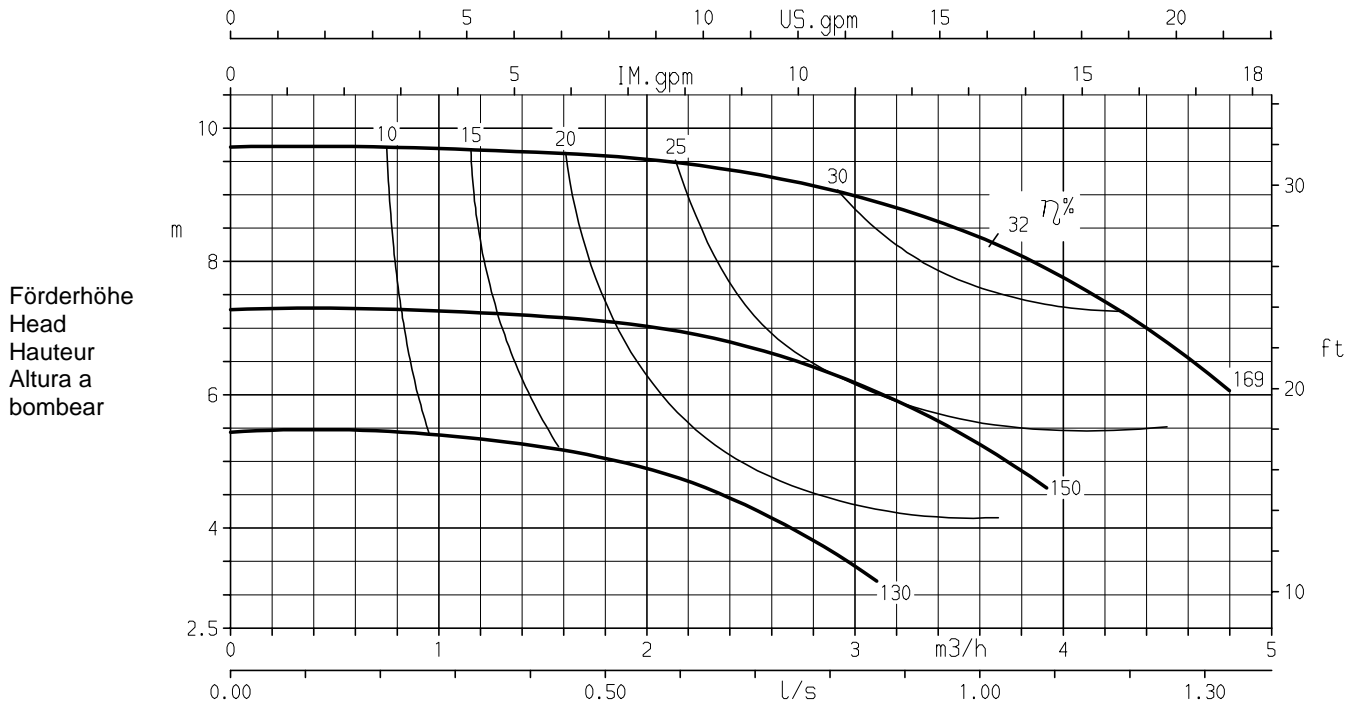

Laufraudausrittsbreite/Impeller outlet width
Largeur à la sortie de la roue/Anchura de salida del rodete

6 mm
6 mm

K 2721.454/71/3

Förderstrom/Capacity/Débit/Caudal

Baureihe Pump type	Modèle Tipo	Nenn Drehzahl Nom. speed	Vitesse nom. Revoluciones nom.	 KSB KSB Aktiengesellschaft Pumpen Industrie- und Wassertechnik Postfach 13 60, D-91253 Pegnitz Bahnhofplatz 1, D-91257
CPK/HPK	25-200	1450 1/min		
Angebots-Nr. Project No.	No. de l'offre Oferta-No.	Pos.-Nr. Item No.	No. de pos. No. de pos.	

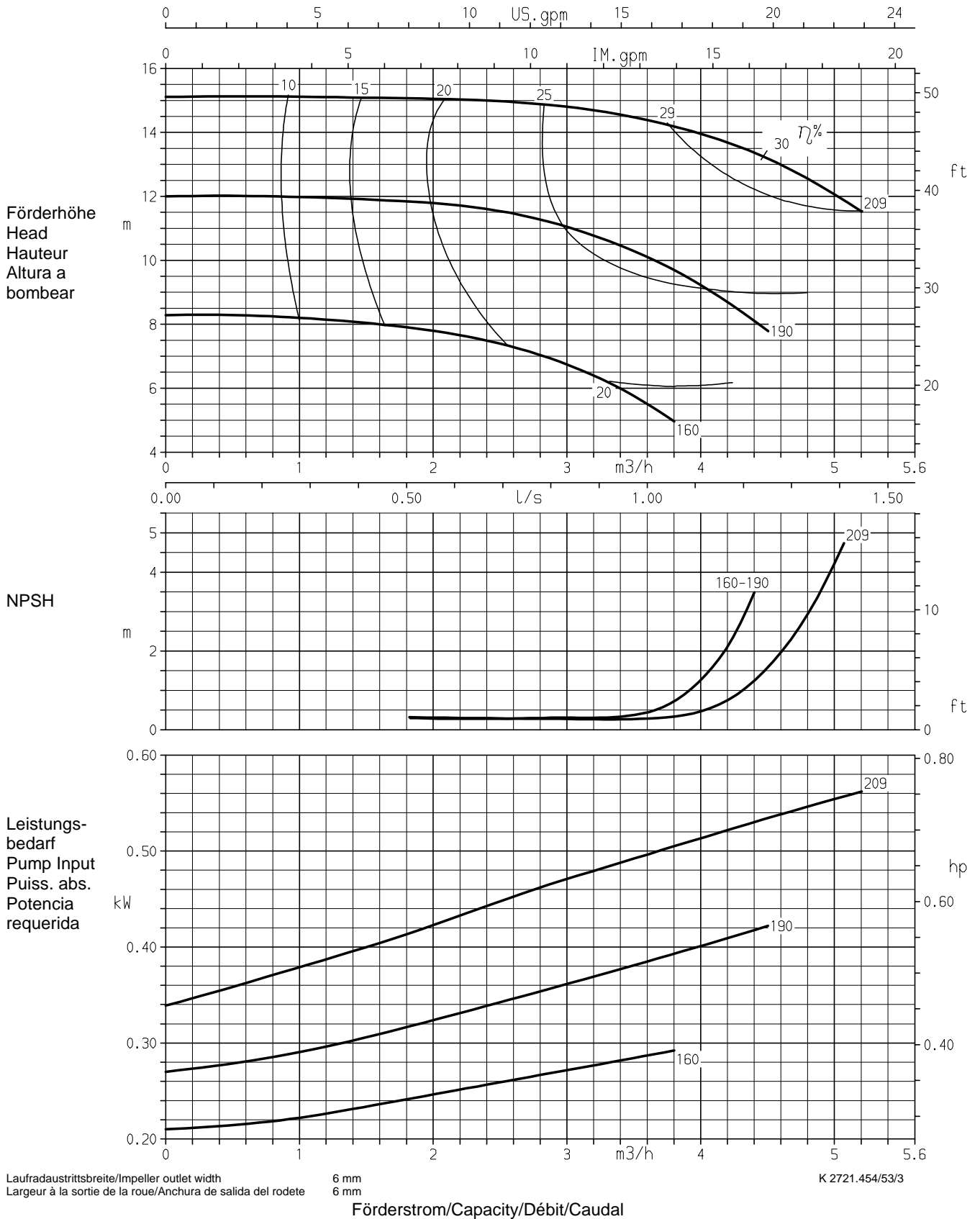

Baureihe Pump type	Modèle Tipo	Nenn Drehzahl Nom. speed	Vitesse nom. Revoluciones nom.	 KSB Aktiengesellschaft Pumpen Industrie- und Wassertechnik Postfach 13 60, D-91253 Pegnitz Bahnhofplatz 1, D-91257
CPK/HPK	32-125	1450 1/min		
Angebots-Nr. Project No.	No. de l'offre Oferta-No.	Pos.-Nr. Item No.	No. de pos. No. de pos.	

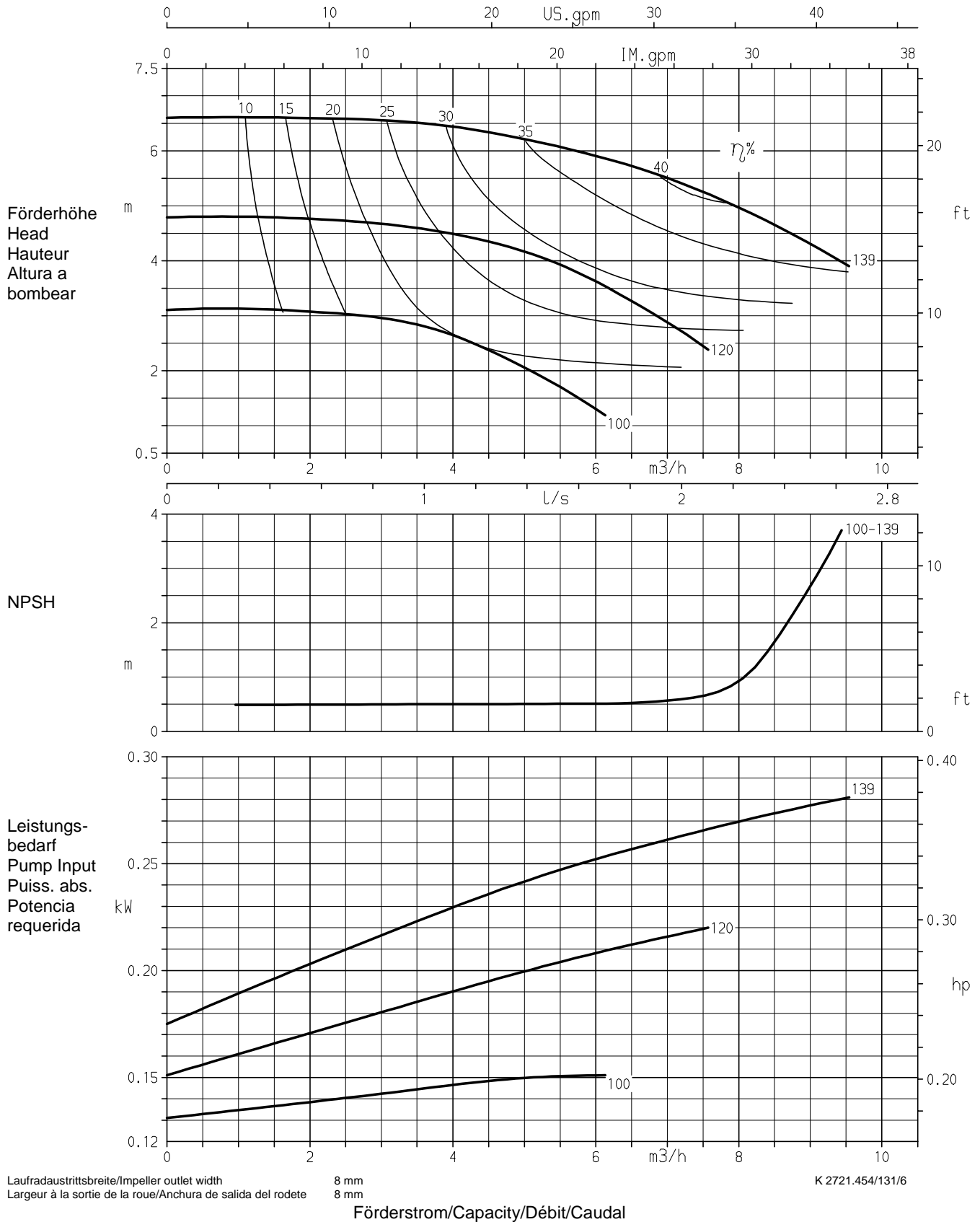

Baureihe Pump type	Modèle Tipo	Nenn Drehzahl Nom. speed	Vitesse nom. Revoluciones nom.	 KSB KSB Aktiengesellschaft Pumpen Industrie- und Wassertechnik Postfach 13 60, D-91253 Pegnitz Bahnhofplatz 1, D-91257
CPK/HPK	32-160	1450 1/min		
Angebots-Nr. Project No.	No. de l'offre Oferta-No.	Pos.-Nr. Item No.	No. de pos. No. de pos.	

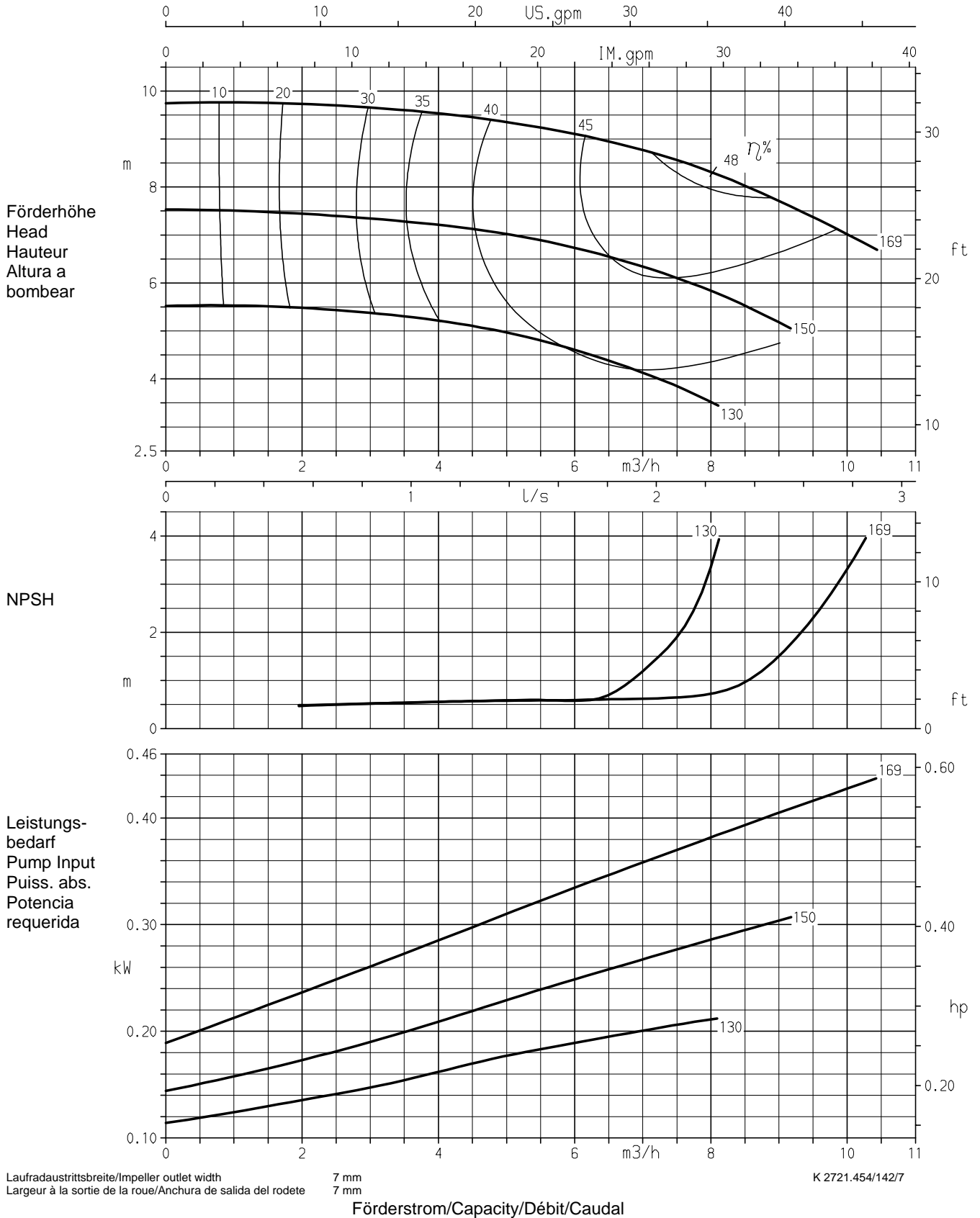

Baureihe Pump type	Modèle Tipo	Nenn Drehzahl Nom. speed	Vitesse nom. Revoluciones nom.	 KSB KSB Aktiengesellschaft Pumpen Industrie- und Wassertechnik Postfach 13 60, D-91253 Pegnitz Bahnhofplatz 1, D-91257
CPK/HPK	32-200	1450 1/min		
Angebots-Nr. Project No.	No. de l'offre Oferta-No.	Pos.-Nr. Item No.	No. de pos. No. de pos.	

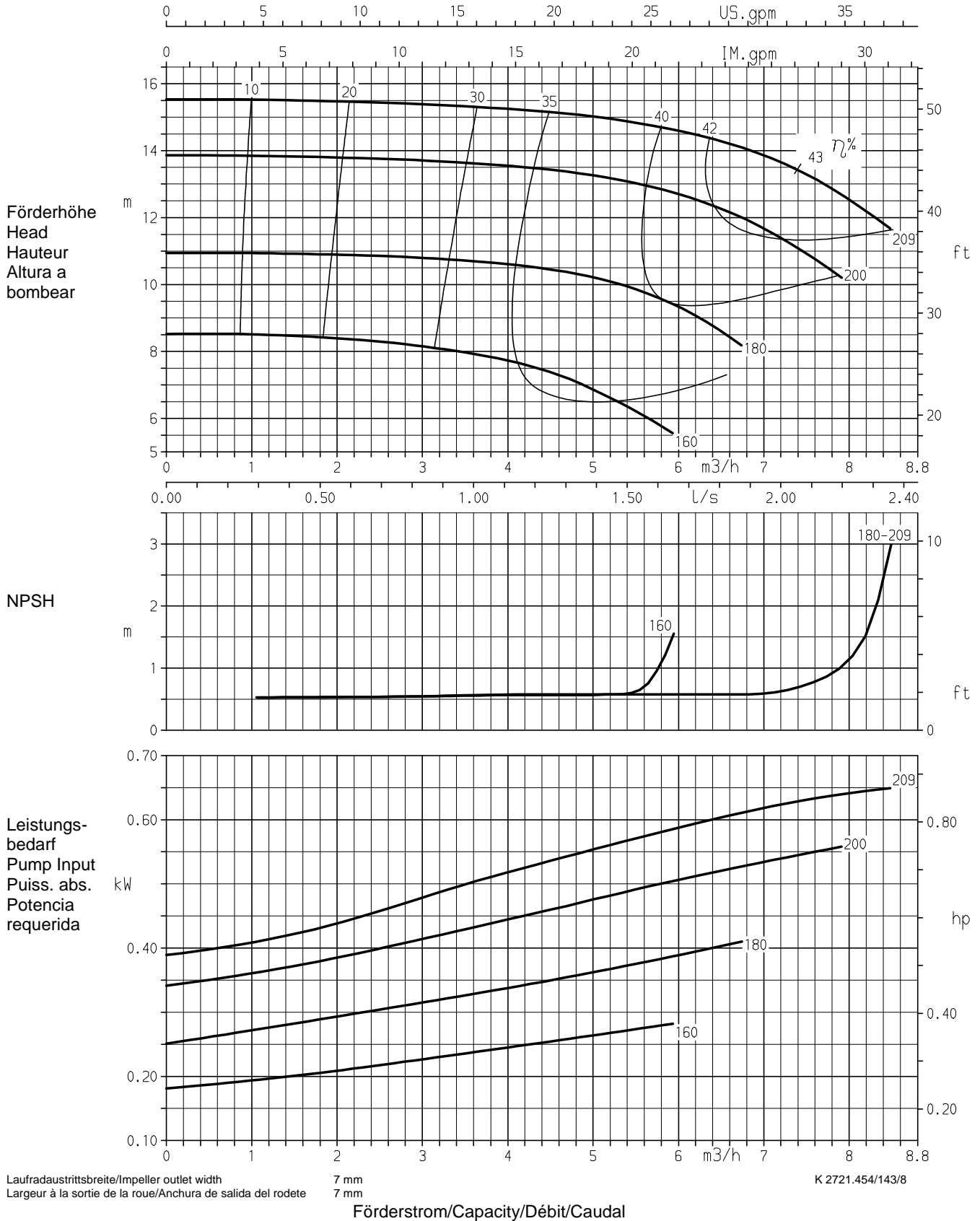

Baureihe Pump type	Modèle Tipo	Nenn Drehzahl Nom. speed	Vitesse nom. Revoluciones nom.	 KSB KSB Aktiengesellschaft Pumpen Industrie- und Wassertechnik Postfach 13 60, D-91253 Pegnitz Bahnhofplatz 1, D-91257
CPK/HPK	32-250	1450 1/min		
Angebots-Nr. Project No.	No. de l'offre Oferta-No.	Pos.-Nr. Item No.	No. de pos. No. de pos.	

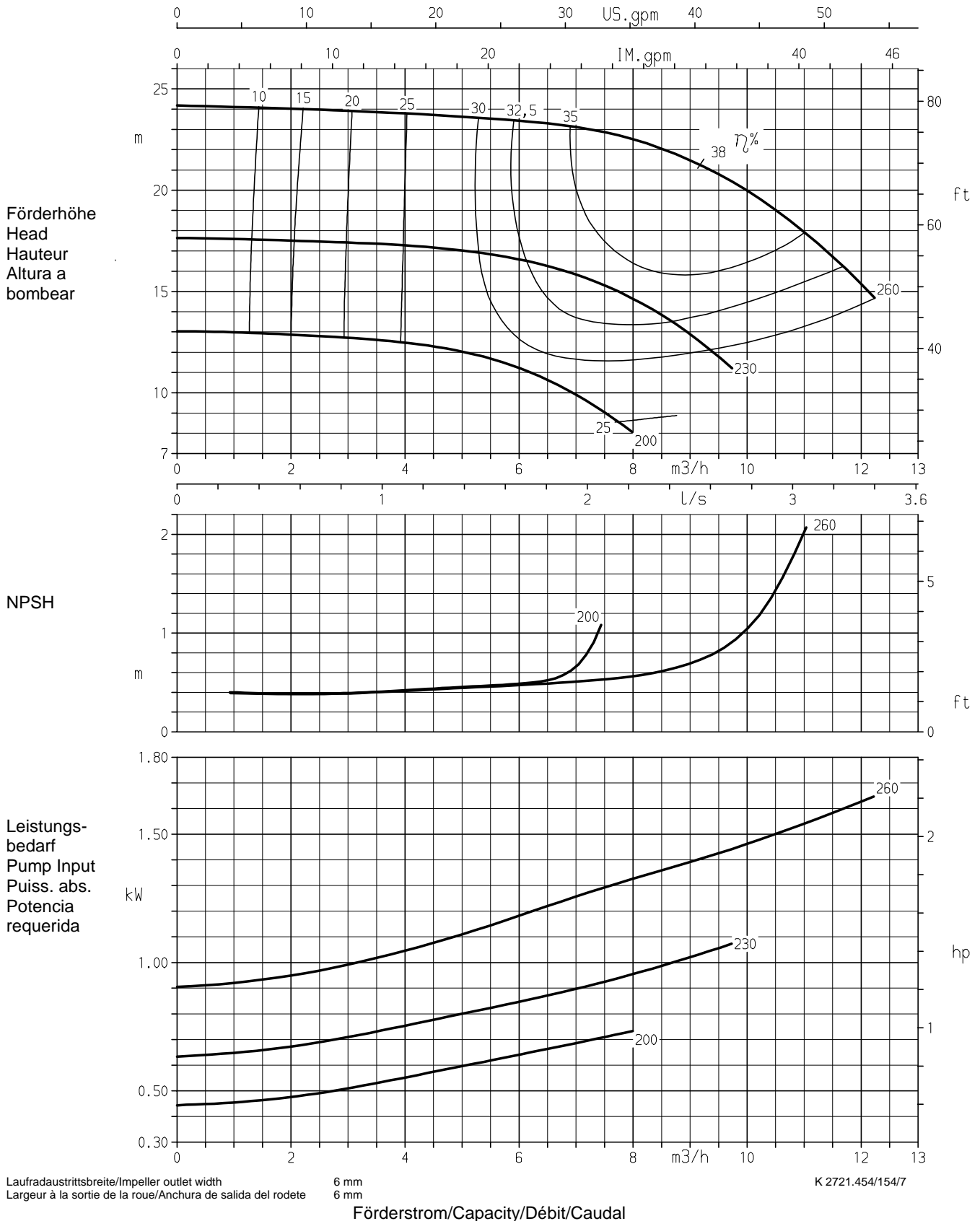

Baureihe Pump type	Modèle Tipo	Nenn Drehzahl Nom. speed	Vitesse nom. Revoluciones nom.	 KSB KSB Aktiengesellschaft Pumpen Industrie- und Wassertechnik Postfach 13 60, D-91253 Pegnitz Bahnhofplatz 1, D-91257
CPK/HPK	40-160	1450 1/min		
Angebots-Nr. Project No.	No. de l'offre Oferta-No.	Pos.-Nr. Item No.	No. de pos. No. de pos.	

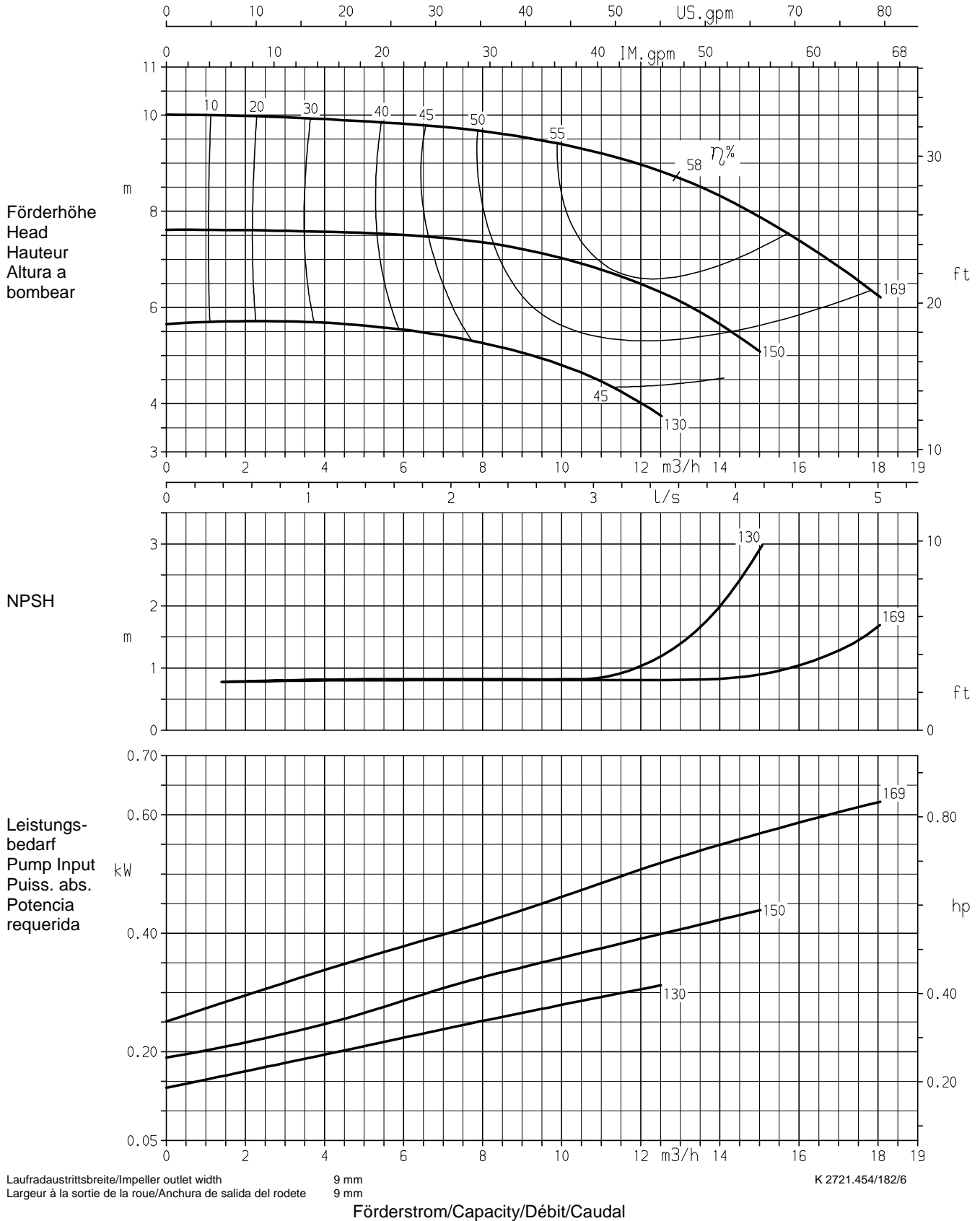

Baureihe Pump type	Modèle Tipo	Nenn Drehzahl Nom. speed	Vitesse nom. Revoluciones nom.	 KSB KSB Aktiengesellschaft Pumpen Industrie- und Wassertechnik Postfach 13 60, D-91253 Pegnitz Bahnhofplatz 1, D-91257
CPK/HPK	40-200	1450 1/min		
Angebots-Nr. Project No.	No. de l'offre Oferta-No.	Pos.-Nr. Item No.	No. de pos. No. de pos.	

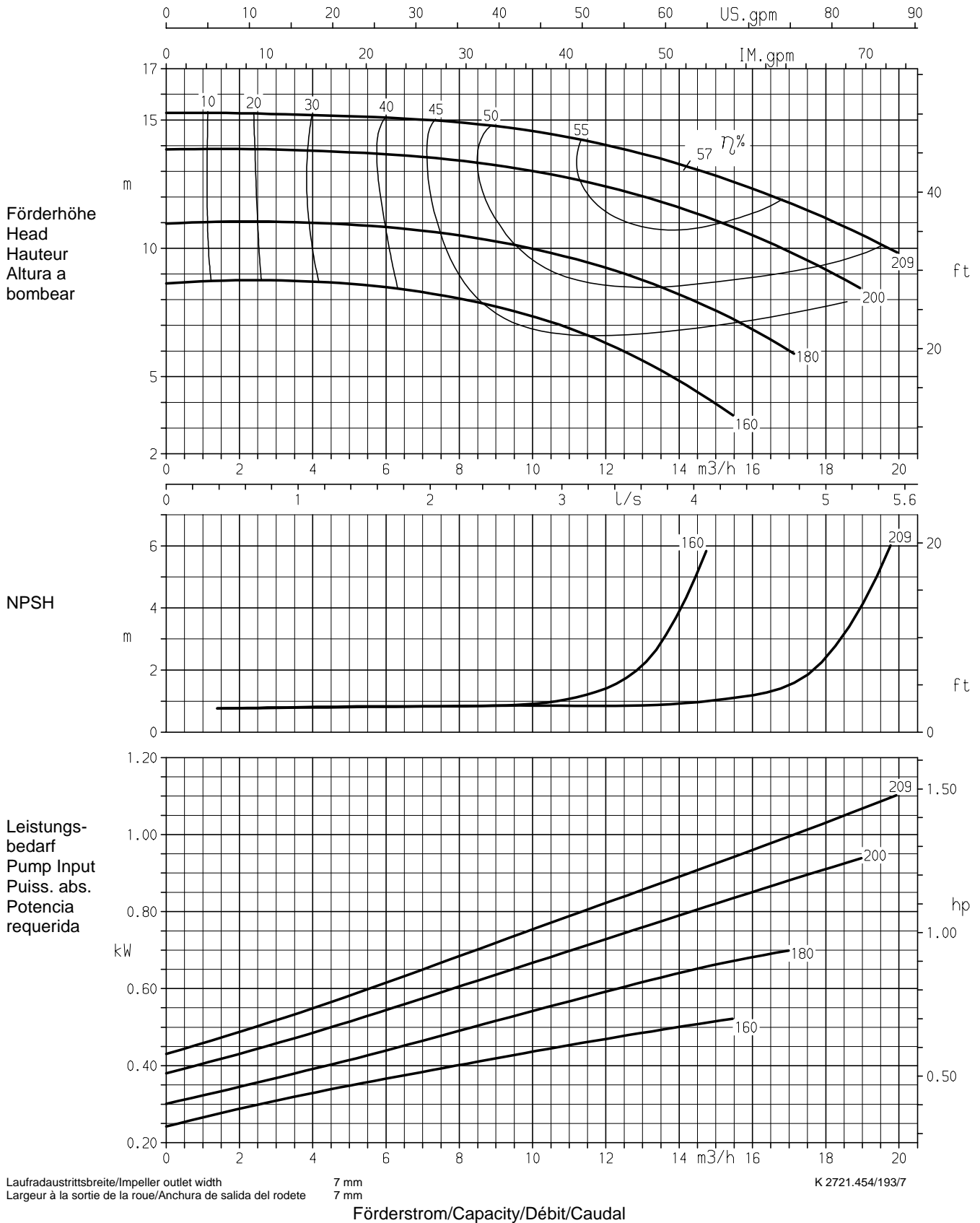

Baureihe Pump type	Modèle Tipo	Nenn Drehzahl Nom. speed	Vitesse nom. Revoluciones nom.	 KSB KSB Aktiengesellschaft Pumpen Industrie- und Wassertechnik Postfach 13 60, D-91253 Pegnitz Bahnhofplatz 1, D-91257
CPK/HPK	40-250	1450 1/min		
Angebots-Nr. Project No.	No. de l'offre Oferta-No.	Pos.-Nr. Item No.	No. de pos. No. de pos.	

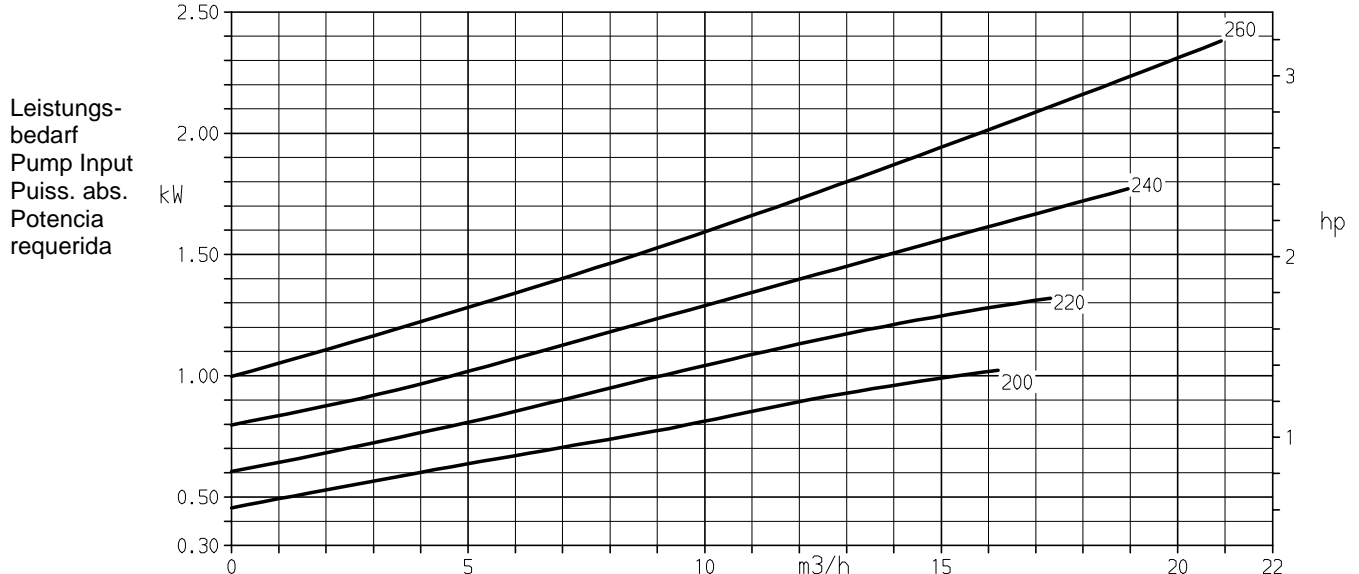
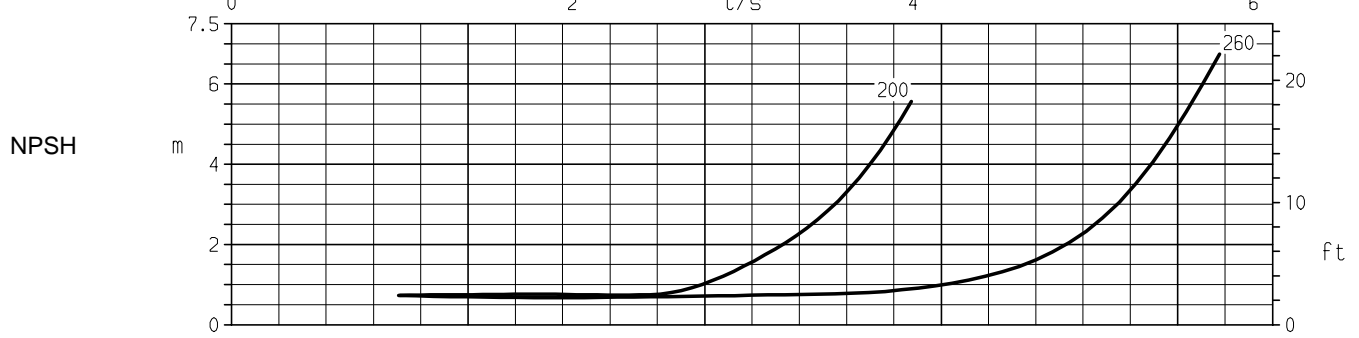
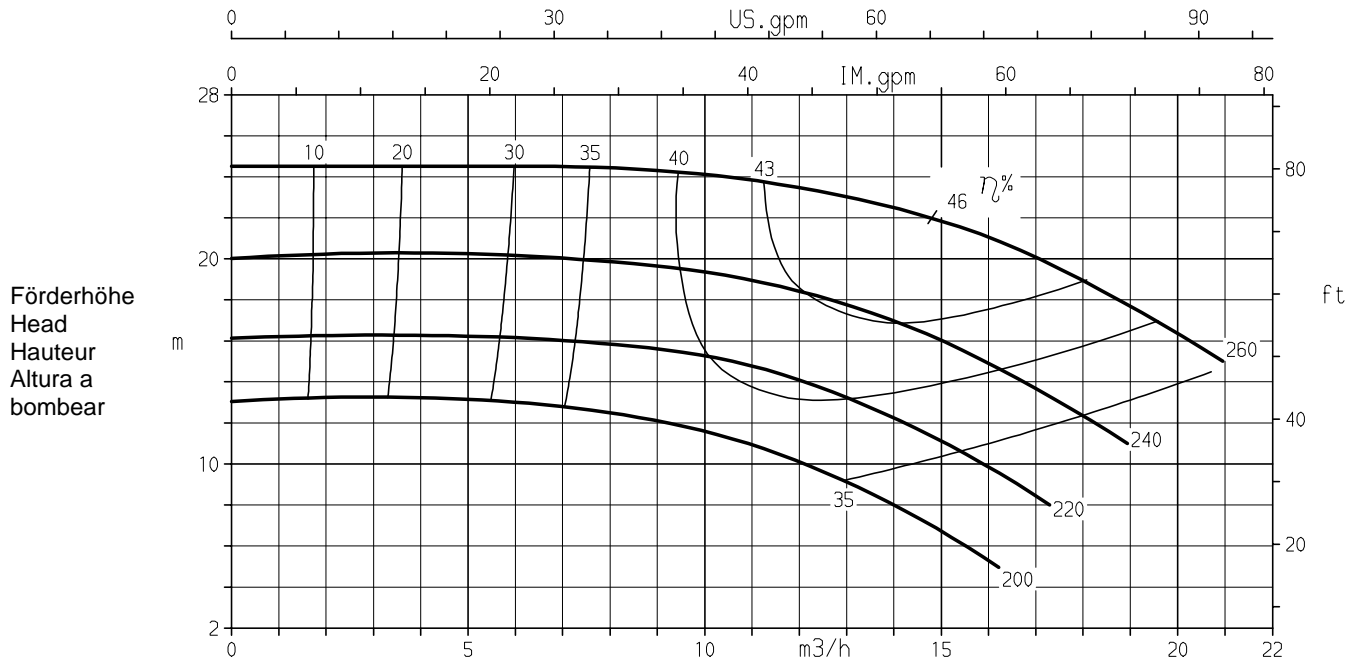

Laufraudaustrittsweite/Impeller outlet width 7 mm
 Largeur à la sortie de la roue/Anchura de salida del rodete 7 mm

K 2721.454/194/7

Baureihe Pump type	Modèle Tipo	Nennzahl Nom. speed	Vitesse nom. Revoluciones nom.	 KSB KSB Aktiengesellschaft Pumpen Industrie- und Wassertechnik Postfach 13 60, D-91253 Pegnitz Bahnhofplatz 1, D-91257
CPK/HPK	40-315	1450 1/min		
Angebots-Nr. Project No.	No. de l'offre Oferta-No.	Pos.-Nr. Item No.	No. de pos. No. de pos.	

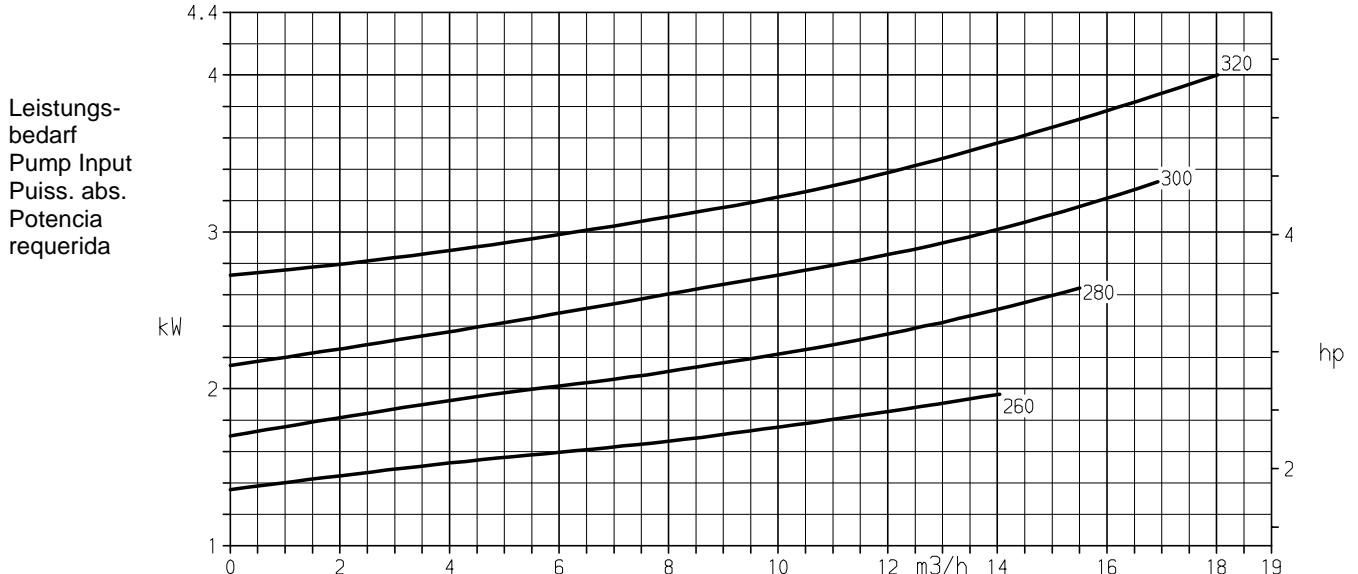
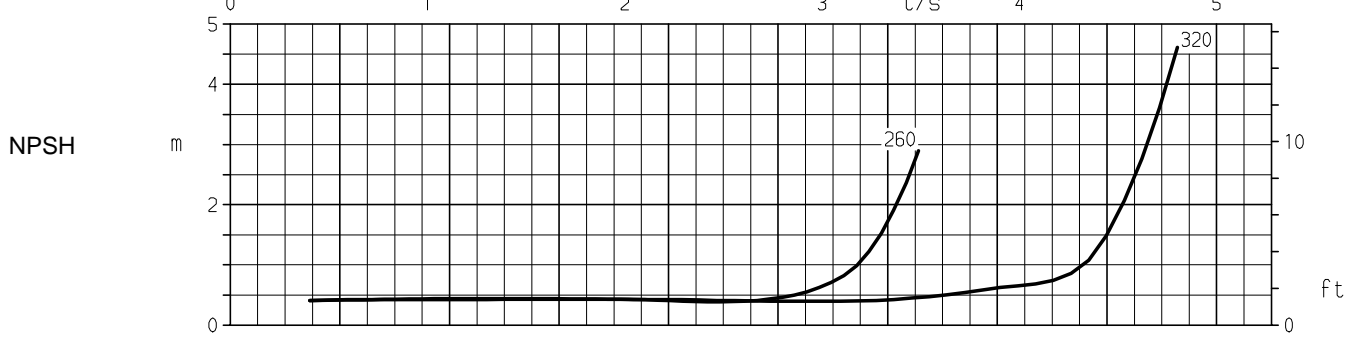
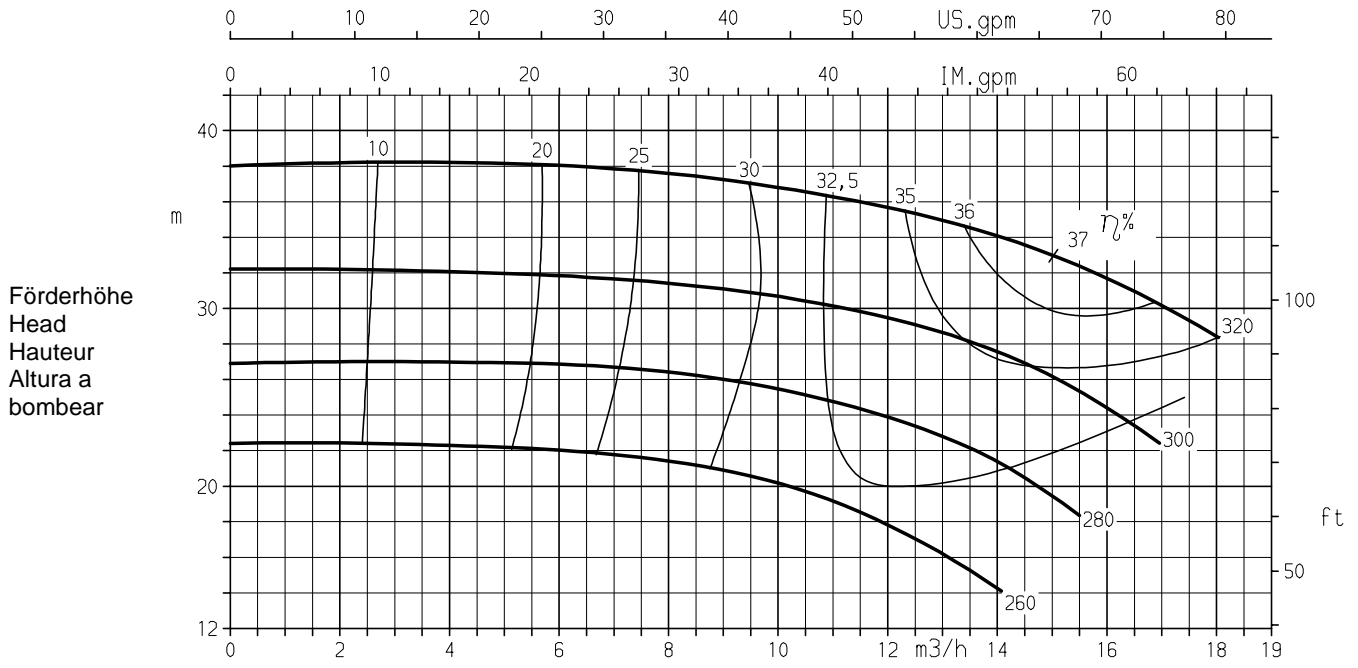

Laufradaustrittsbreite/Impeller outlet width 8 mm
 Largeur à la sortie de la roue/Anchura de salida del rodeté 8 mm
 Förderstrom/Capacity/Débit/Caudal

K 2721.454/195/7

Baureihe Pump type	Modèle Tipo	Nenn Drehzahl Nom. speed	Vitesse nom. Revoluciones nom.	 KSB KSB Aktiengesellschaft Pumpen Industrie- und Wassertechnik Postfach 13 60, D-91253 Pegnitz Bahnhofplatz 1, D-91257
CPK/HPK	50-160	1450 1/min		
Angebots-Nr. Project No.	No. de l'offre Oferta-No.	Pos.-Nr. Item No.	No. de pos. No. de pos.	

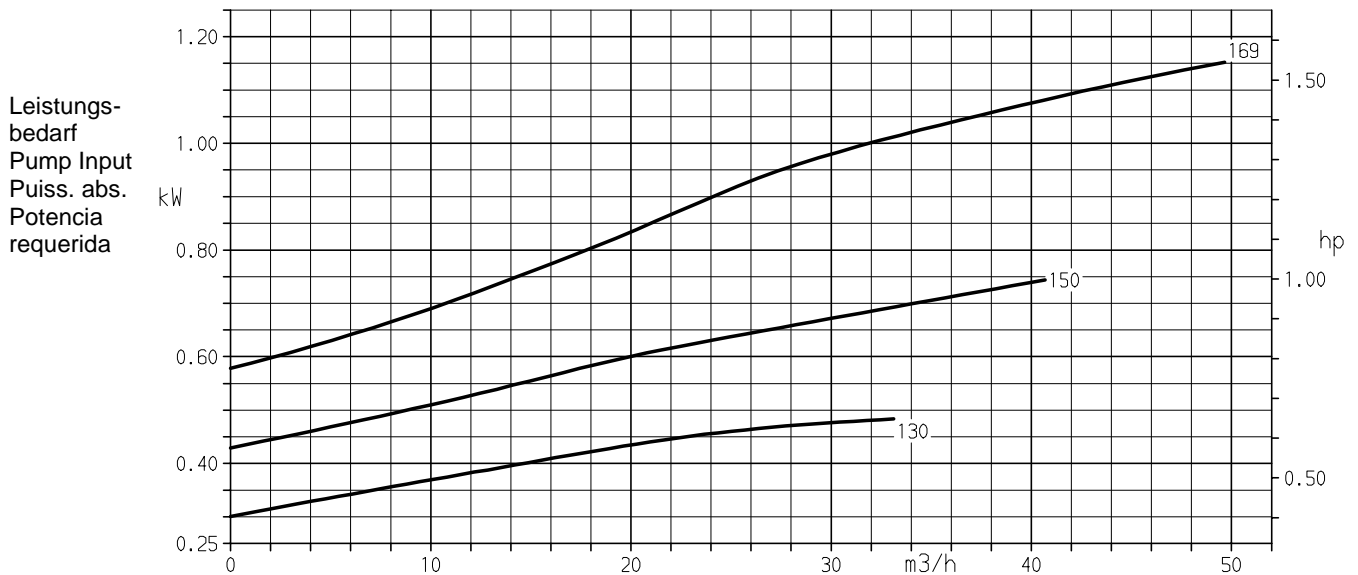
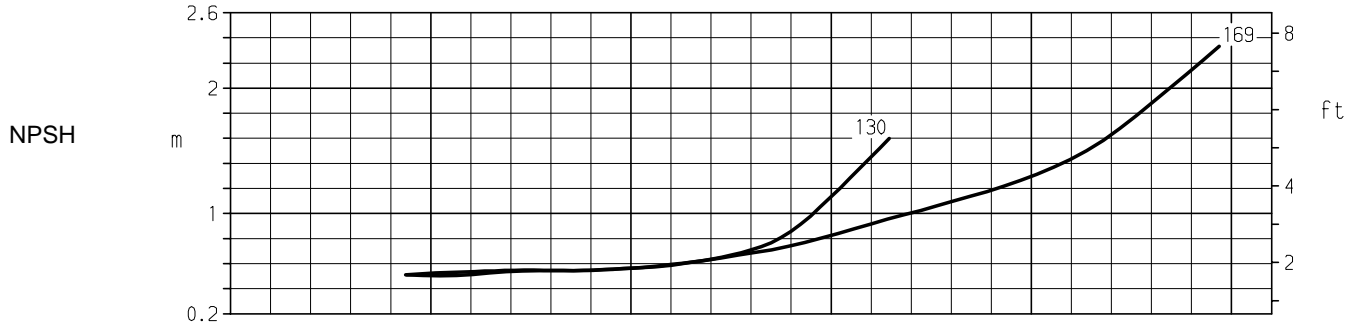
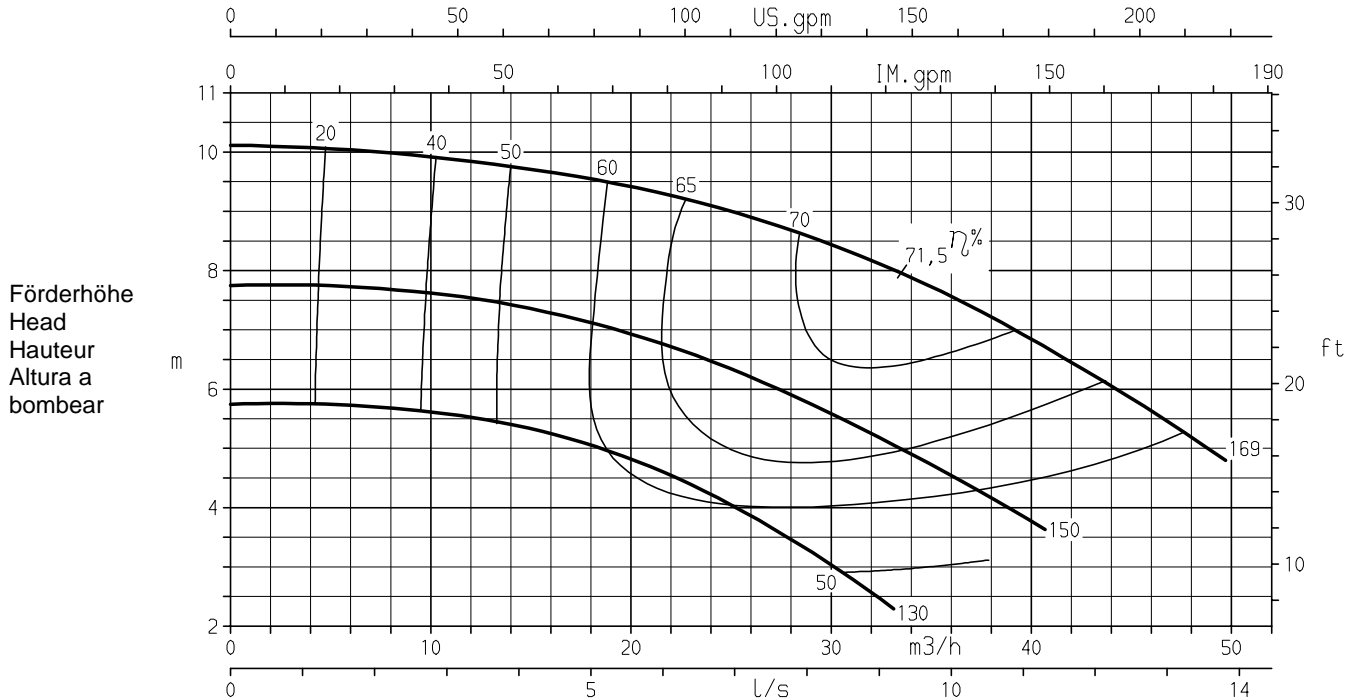

Laufraudaustrittsbreite/Impeller outlet width
Largeur à la sortie de la roue/Anchura de salida del rodete

15 mm
15 mm

K 2721.454/262/5

Förderstrom/Capacity/Débit/Caudal

Baureihe Pump type	Modèle Tipo	Nenn Drehzahl Nom. speed	Vitesse nom. Revoluciones nom.	 KSB KSB Aktiengesellschaft Pumpen Industrie- und Wassertechnik Postfach 13 60, D-91253 Pegnitz Bahnhofplatz 1, D-91257
CPK/HPK	50-200	1450 1/min		
Angebots-Nr. Project No.	No. de l'offre Oferta-No.	Pos.-Nr. Item No.	No. de pos. No. de pos.	

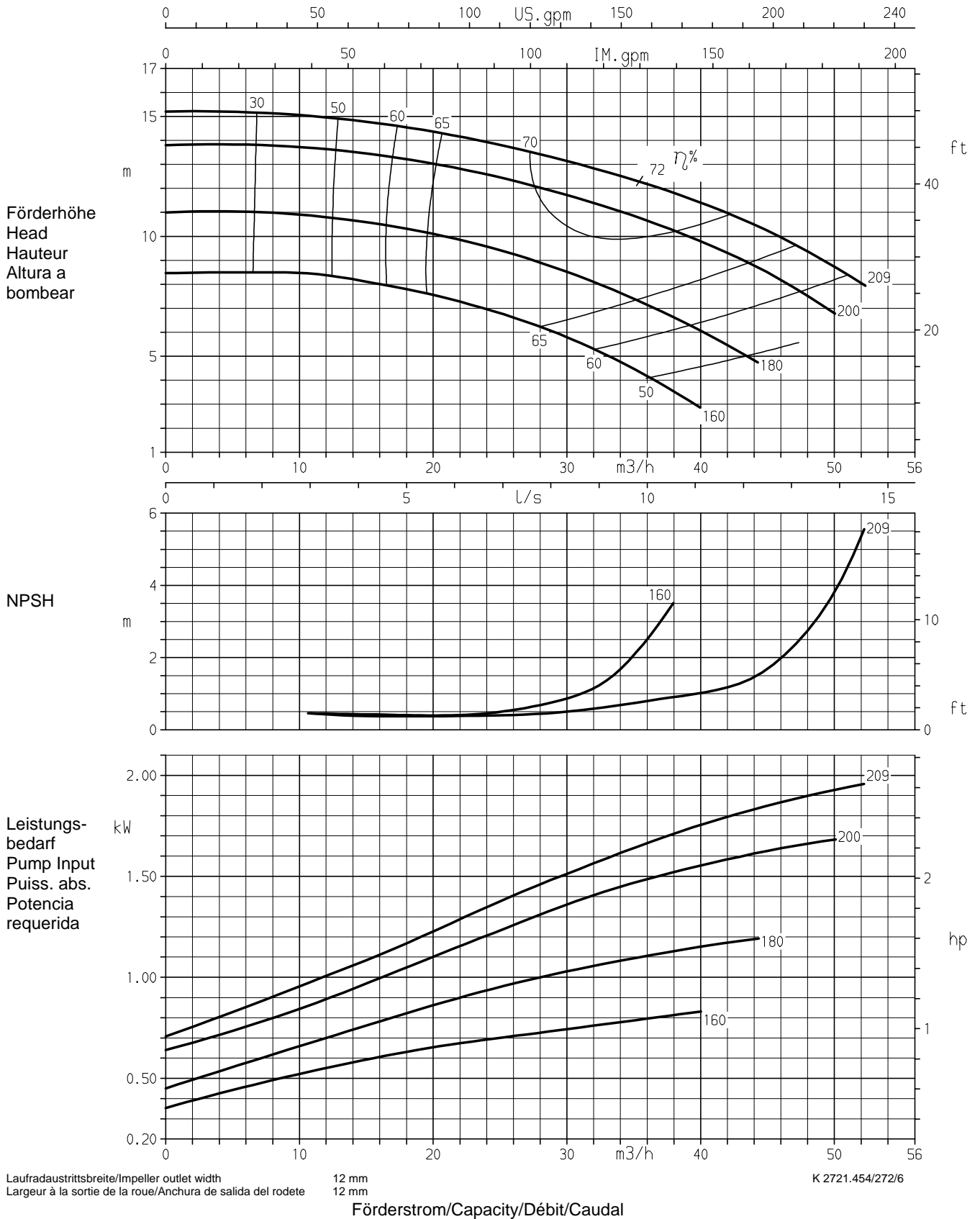

Baureihe Pump type	Modèle Tipo	Nenn Drehzahl Nom. speed	Vitesse nom. Revoluciones nom.	 KSB KSB Aktiengesellschaft Pumpen Industrie- und Wassertechnik Postfach 13 60, D-91253 Pegnitz Bahnhofplatz 1, D-91257
CPK/HPK	50-250	1450 1/min		
Angebots-Nr. Project No.	No. de l'offre Oferta-No.	Pos.-Nr. Item No.	No. de pos. No. de pos.	

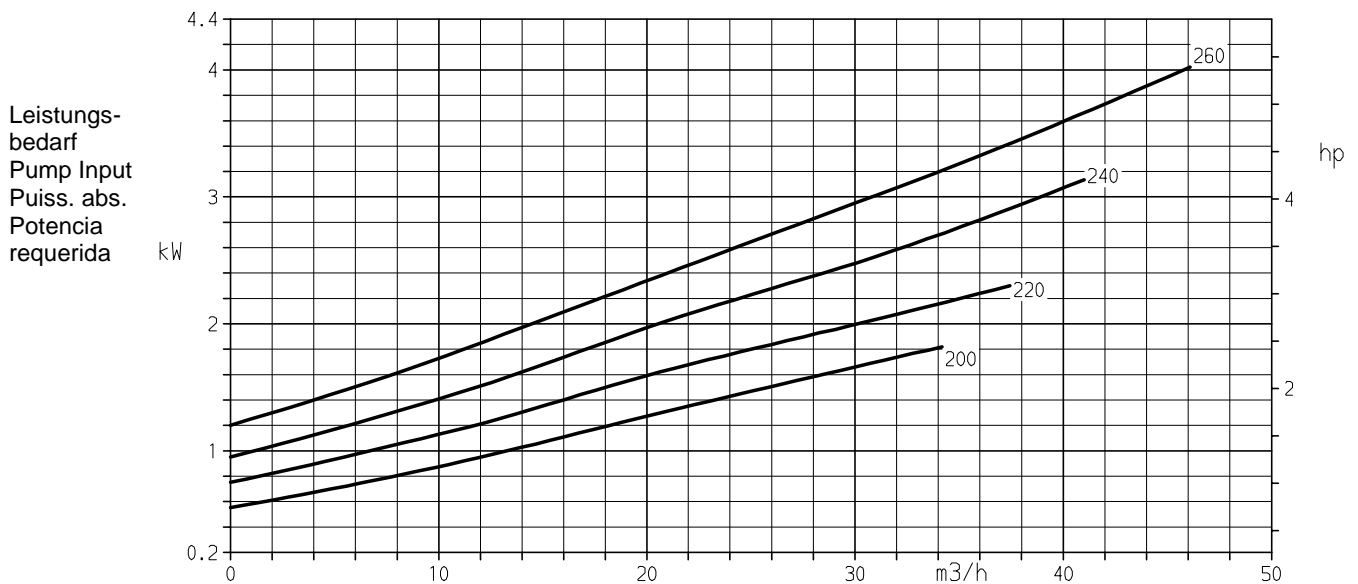
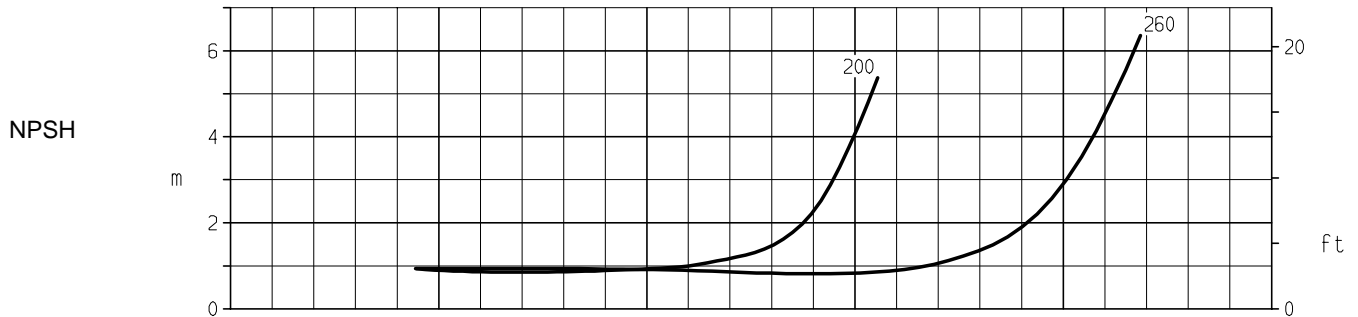
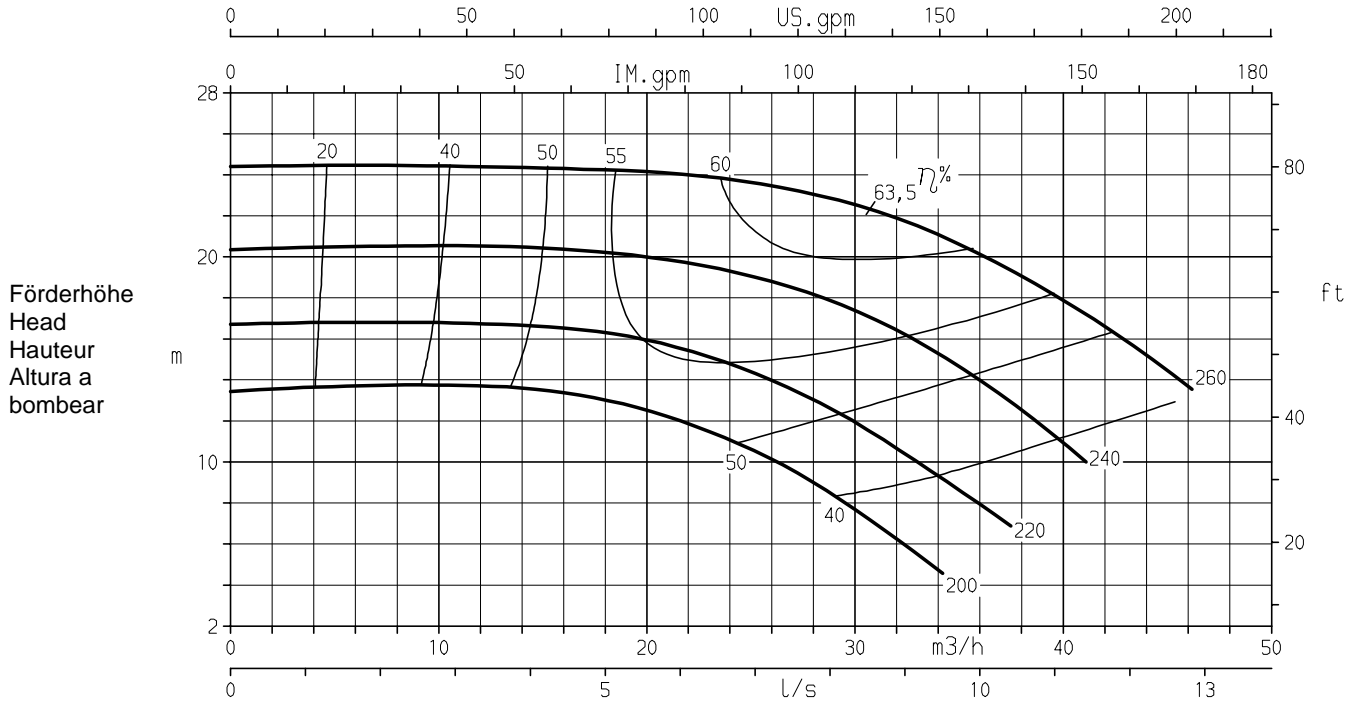

Laufraudausrittsbreite/Impeller outlet width
Largeur à la sortie de la roue/Anchura de salida del rodete

10 mm
10 mm

K 2721.454/254/7

Förderstrom/Capacity/Débit/Caudal

Baureihe Pump type	Modèle Tipo	Nennzahl Nom. speed	Vitesse nom. Revoluciones nom.	 KSB KSB Aktiengesellschaft Pumpen Industrie- und Wassertechnik Postfach 13 60, D-91253 Pegnitz Bahnhofplatz 1, D-91257
CPK/HPK	50-315	1450 1/min		
Angebots-Nr. Project No.	No. de l'offre Oferta-No.	Pos.-Nr. Item No.	No. de pos. No. de pos.	

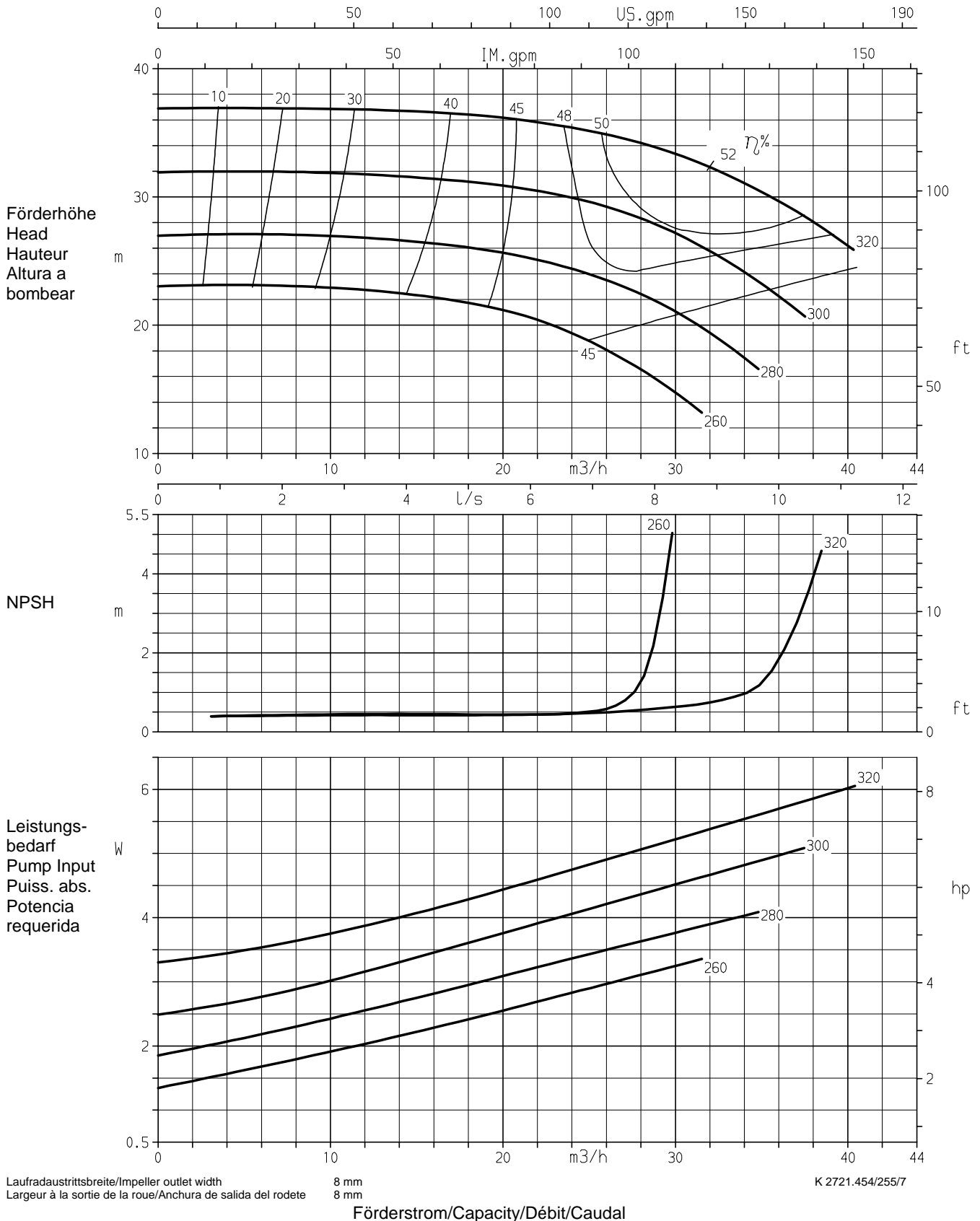

Baureihe Pump type	Modèle Tipo	Nenn Drehzahl Nom. speed	Vitesse nom. Revoluciones nom.	 KSB KSB Aktiengesellschaft Pumpen Industrie- und Wassertechnik Postfach 13 60, D-91253 Pegnitz Bahnhofplatz 1, D-91257
CPK/HPK	65-160	1450 1/min		
Angebots-Nr. Project No.	No. de l'offre Oferta-No.	Pos.-Nr. Item No.	No. de pos. No. de pos.	

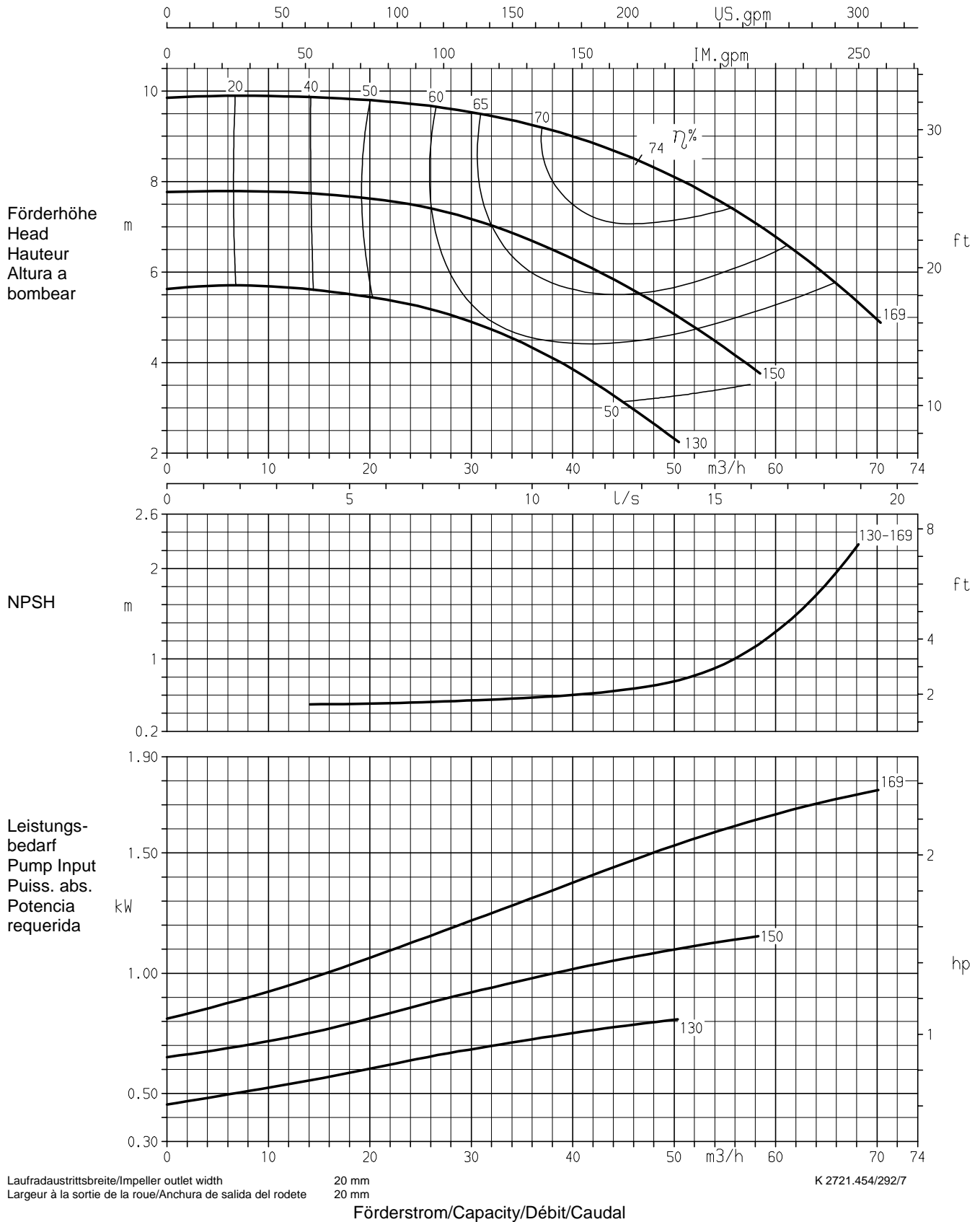

Baureihe Pump type	Modèle Tipo	Nennzahl Nom. speed	Vitesse nom. Revoluciones nom.	 KSB KSB Aktiengesellschaft Pumpen Industrie- und Wassertechnik Postfach 13 60, D-91253 Pegnitz Bahnhofplatz 1, D-91257
CPK/HPK	65-200	1450 1/min		
Angebots-Nr. Project No.	No. de l'offre Oferta-No.	Pos.-Nr. Item No.	No. de pos. No. de pos.	

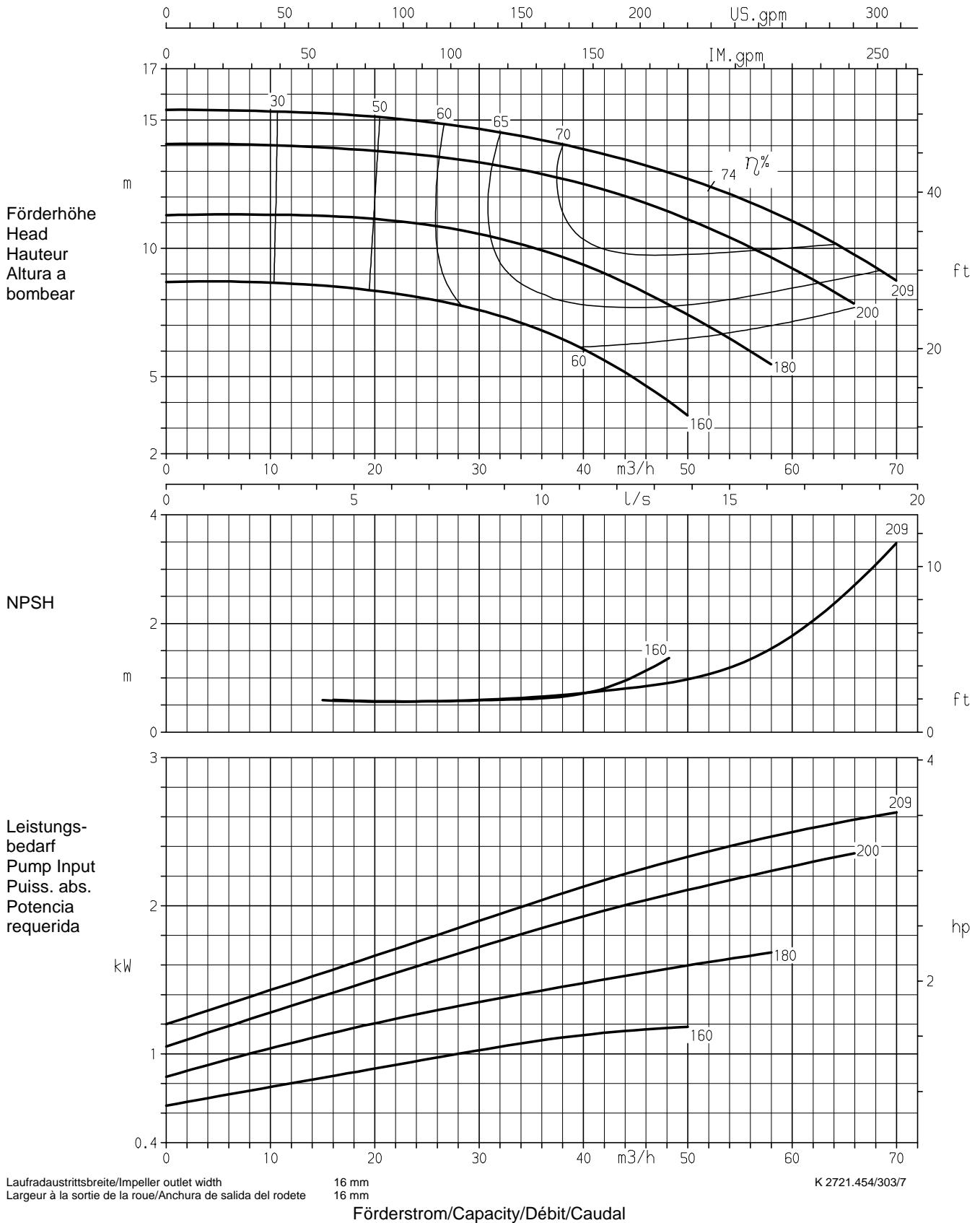

Baureihe Pump type	Modèle Tipo	Nenn Drehzahl Nom. speed	Vitesse nom. Revoluciones nom.	 KSB KSB Aktiengesellschaft Pumpen Industrie- und Wassertechnik Postfach 13 60, D-91253 Pegnitz Bahnhofplatz 1, D-91257
CPK/HPK	65-250	1450 1/min		
Angebots-Nr. Project No.	No. de l'offre Oferta-No.	Pos.-Nr. Item No.	No. de pos. No. de pos.	

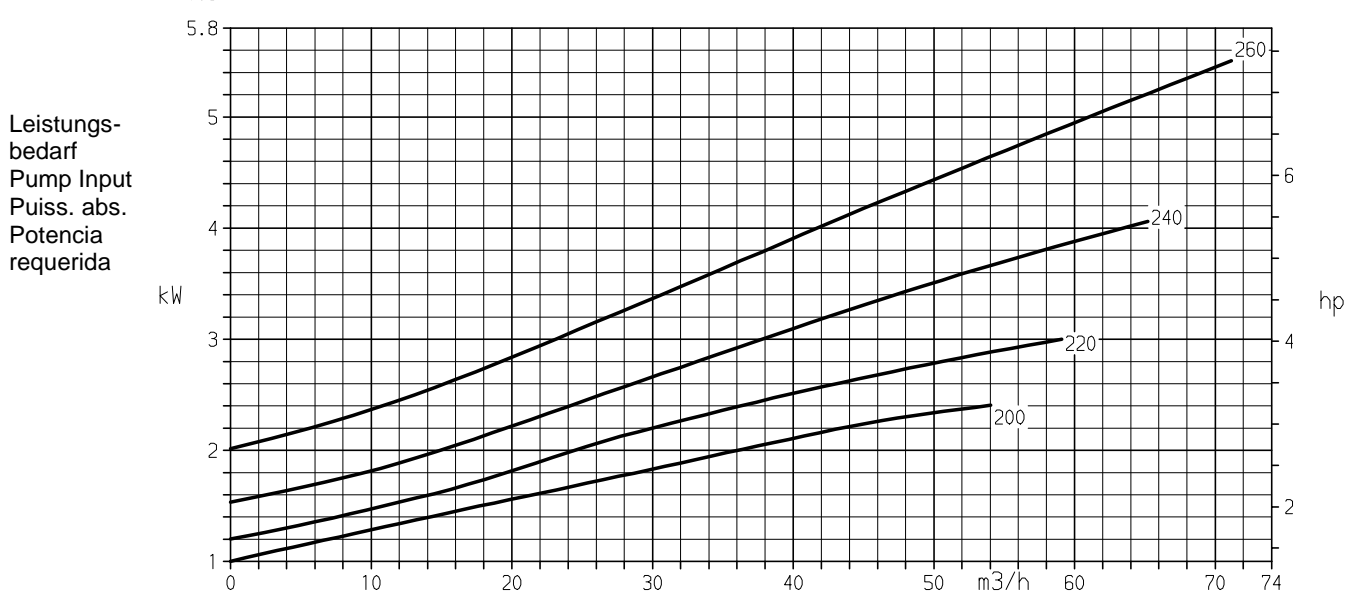
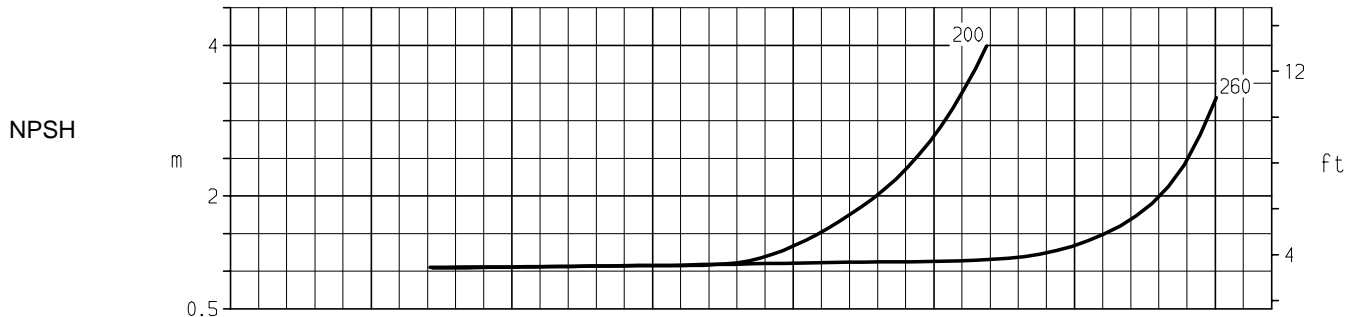
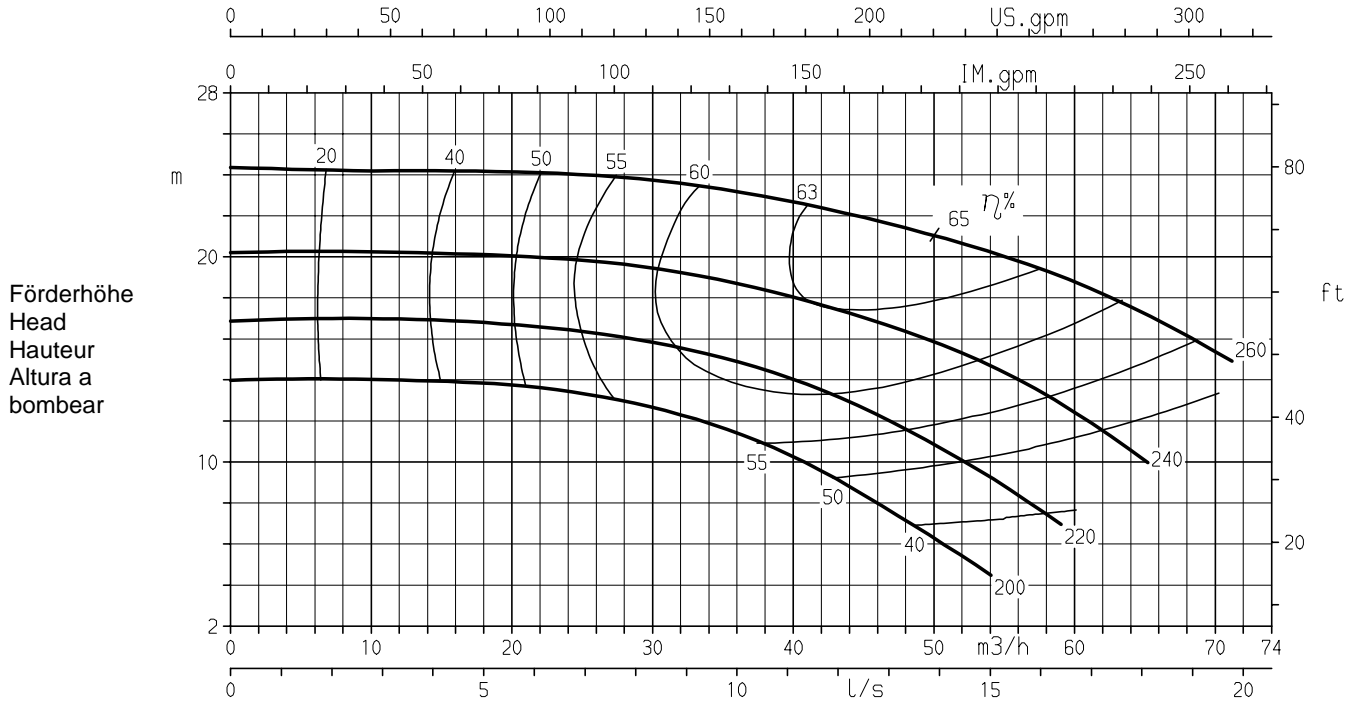

Laufraudausrittsbreite/Impeller outlet width
Largeur à la sortie de la roue/Anchura de salida del rodete

13 mm
13 mm

K 2721.454/294/7

Förderstrom/Capacity/Débit/Caudal

Baureihe Pump type	Modèle Tipo	Nennzahl Nom. speed	Vitesse nom. Revoluciones nom.	 KSB KSB Aktiengesellschaft Pumpen Industrie- und Wassertechnik Postfach 13 60, D-91253 Pegnitz Bahnhofplatz 1, D-91257
CPK/HPK	65-315	1450 1/min		
Angebots-Nr. Project No.	No. de l'offre Oferta-No.	Pos.-Nr. Item No.	No. de pos. No. de pos.	

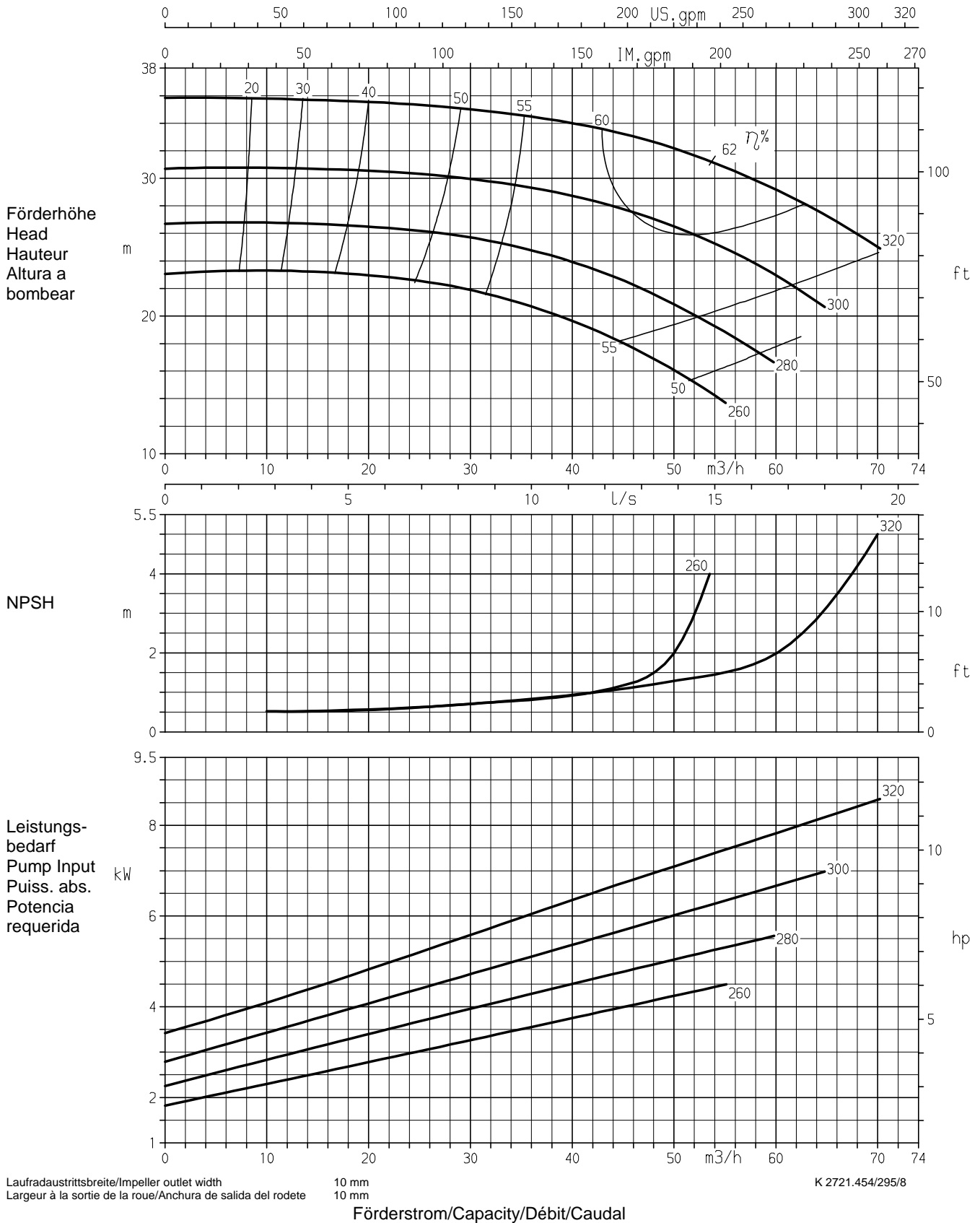

Baureihe Pump type	Modèle Tipo	Nenn Drehzahl Nom. speed	Vitesse nom. Revoluciones nom.	 KSB KSB Aktiengesellschaft Pumpen Industrie- und Wassertechnik Postfach 13 60, D-91253 Pegnitz Bahnhofplatz 1, D-91257
CPK/HPK	80-160	1450 1/min		
Angebots-Nr. Project No.	No. de l'offre Oferta-No.	Pos.-Nr. Item No.	No. de pos. No. de pos.	

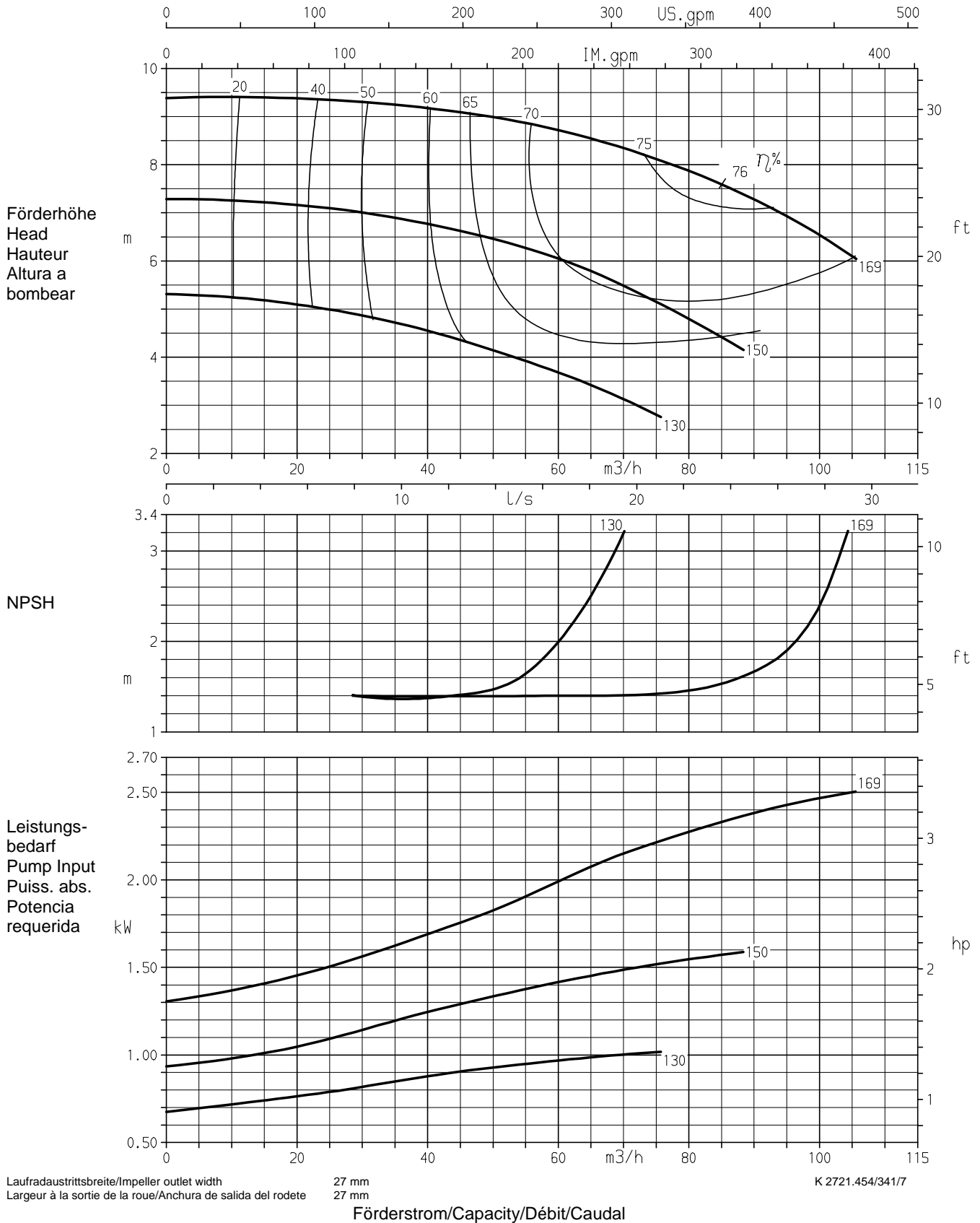

Baureihe Pump type	Modèle Tipo	Nennrehzahl Nom. speed	Vitesse nom. Revoluciones nom.	 KSB KSB Aktiengesellschaft Pumpen Industrie- und Wassertechnik Postfach 13 60, D-91253 Pegnitz Bahnhofplatz 1, D-91257
CPK/HPK	80-200	1450 1/min		
Angebots-Nr. Project No.	No. de l'offre Oferta-No.	Pos.-Nr. Item No.	No. de pos. No. de pos.	

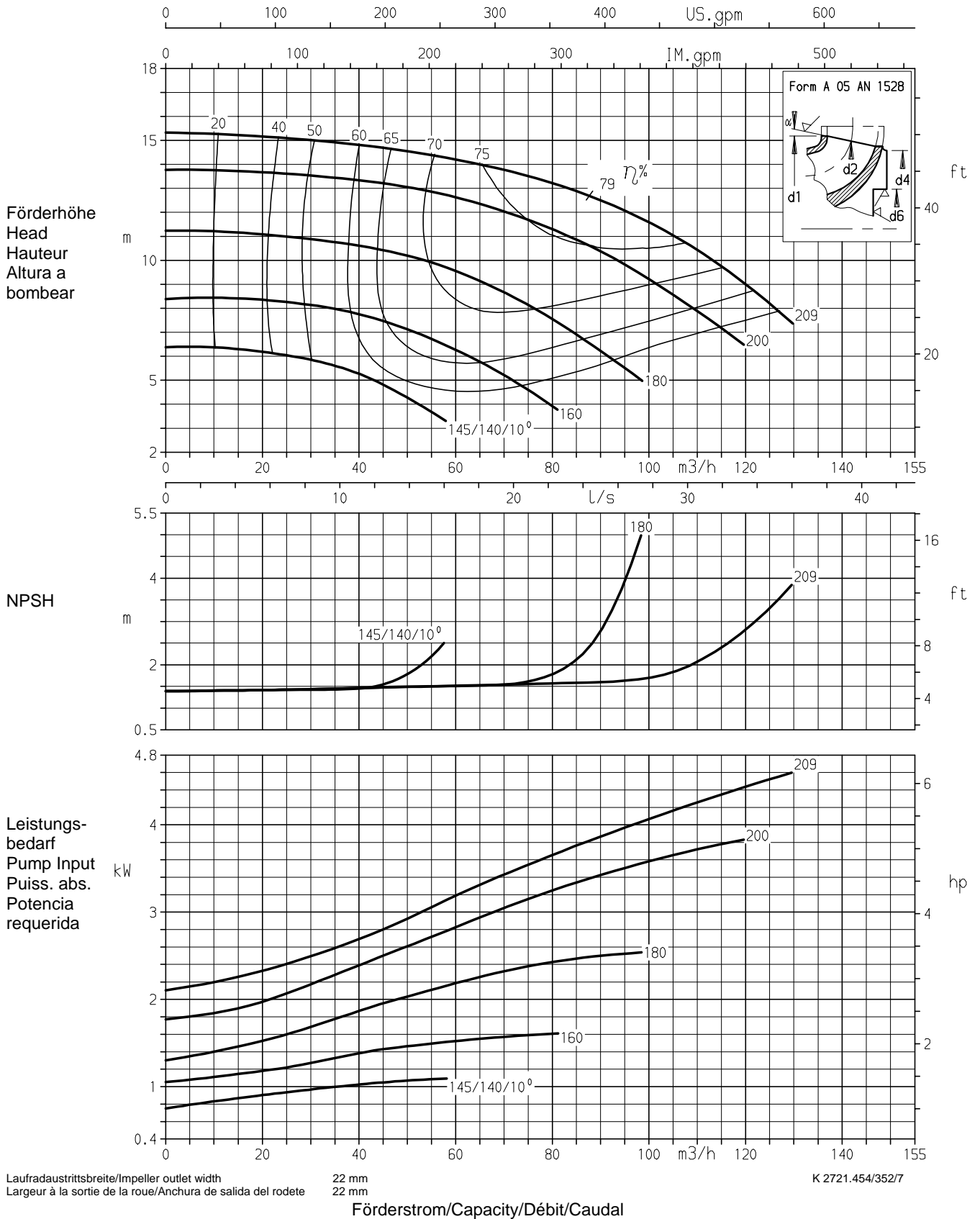

Baureihe Pump type	Modèle Tipo	Nenn Drehzahl Nom. speed	Vitesse nom. Revoluciones nom.	 KSB KSB Aktiengesellschaft Pumpen Industrie- und Wassertechnik Postfach 13 60, D-91253 Pegnitz Bahnhofplatz 1, D-91257
CPK/HPK	80-250	1450 1/min		
Angebots-Nr. Project No.	No. de l'offre Oferta-No.	Pos.-Nr. Item No.	No. de pos. No. de pos.	

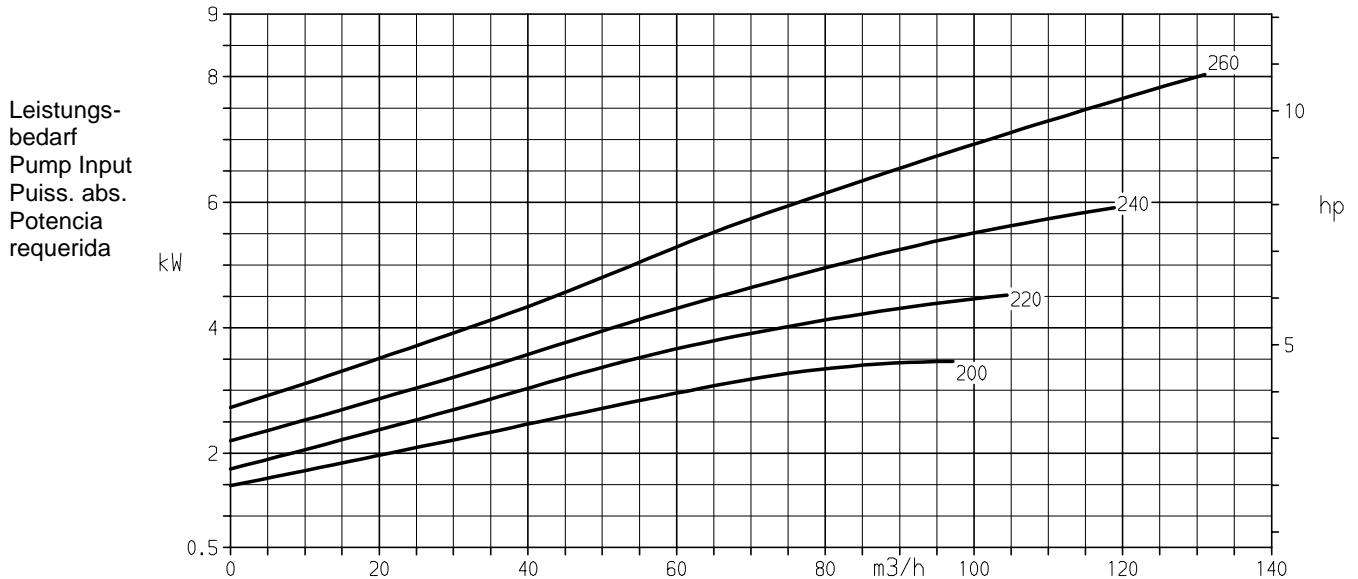
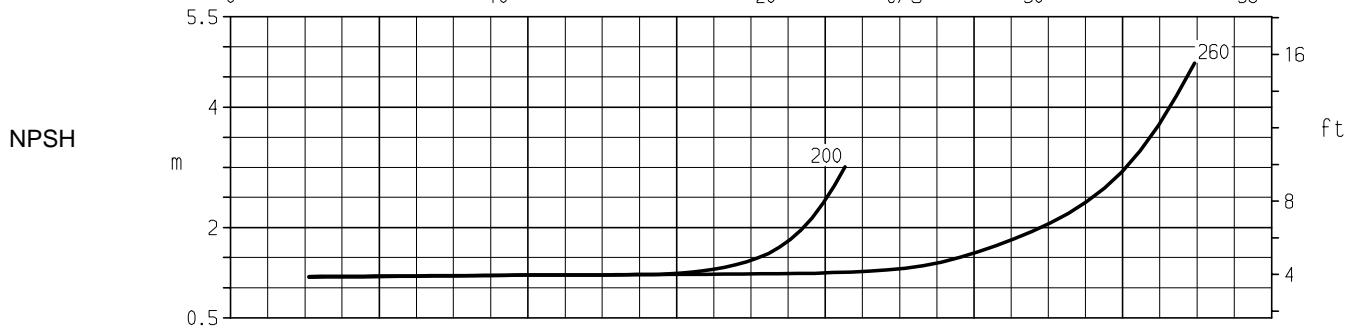
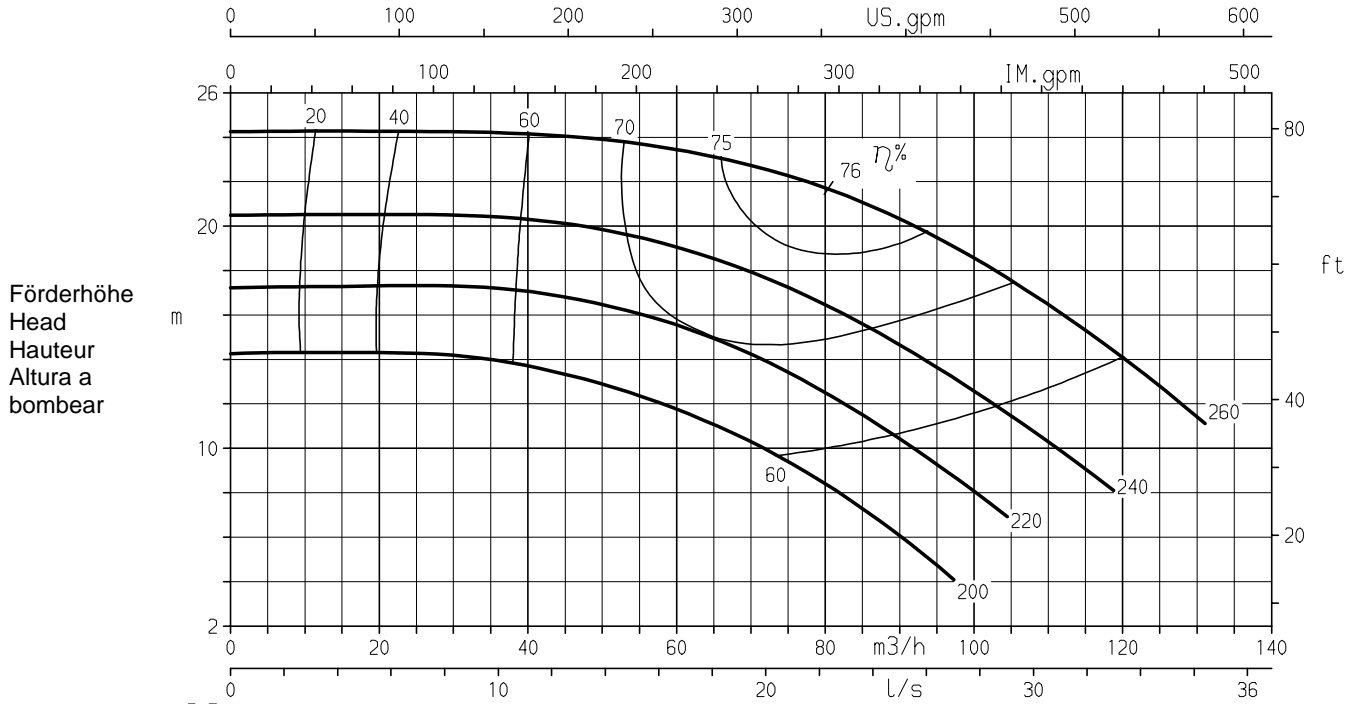

Laufraudaustrittsbreite/Impeller outlet width
Largeur à la sortie de la roue/Anchura de salida del rodete

17 mm
17 mm

K 2721.454/354/7

Förderstrom/Capacity/Débit/Caudal

Baureihe Pump type	Modèle Tipo	Nenn Drehzahl Nom. speed	Vitesse nom. Revoluciones nom.	 KSB KSB Aktiengesellschaft Pumpen Industrie- und Wassertechnik Postfach 13 60, D-91253 Pegnitz Bahnhofplatz 1, D-91257
CPK/HPK	80-315	1450 1/min		
Angebots-Nr. Project No.	No. de l'offre Oferta-No.	Pos.-Nr. Item No.	No. de pos. No. de pos.	

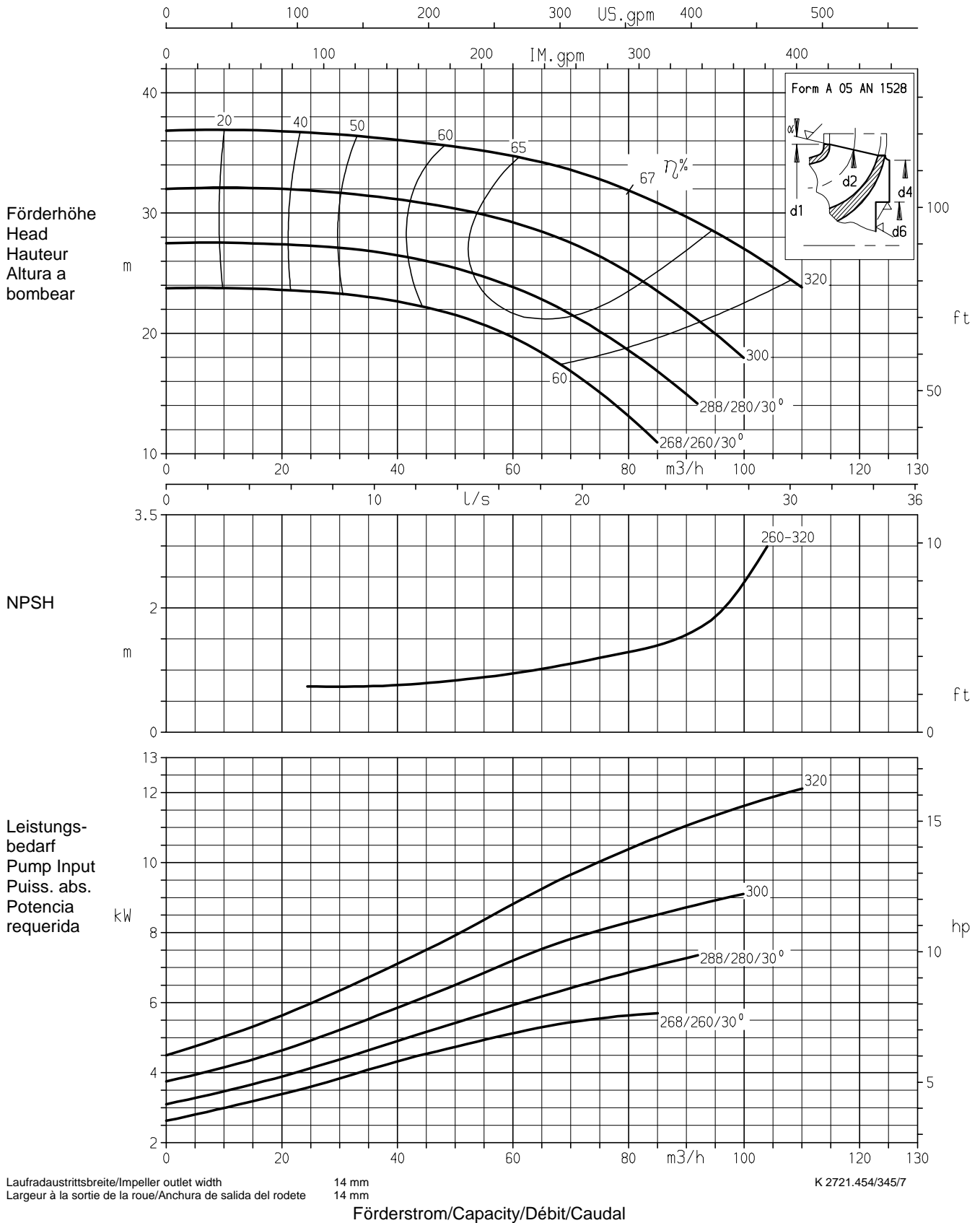

Baureihe Pump type	Modèle Tipo	Nenn Drehzahl Nom. speed	Vitesse nom. Revoluciones nom.	 KSB KSB Aktiengesellschaft Pumpen Industrie- und Wassertechnik Postfach 13 60, D-91253 Pegnitz Bahnhofplatz 1, D-91257
CPK/HPK	80-400	1450 1/min		
Angebots-Nr. Project No.	No. de l'offre Oferta-No.	Pos.-Nr. Item No.	No. de pos. No. de pos.	

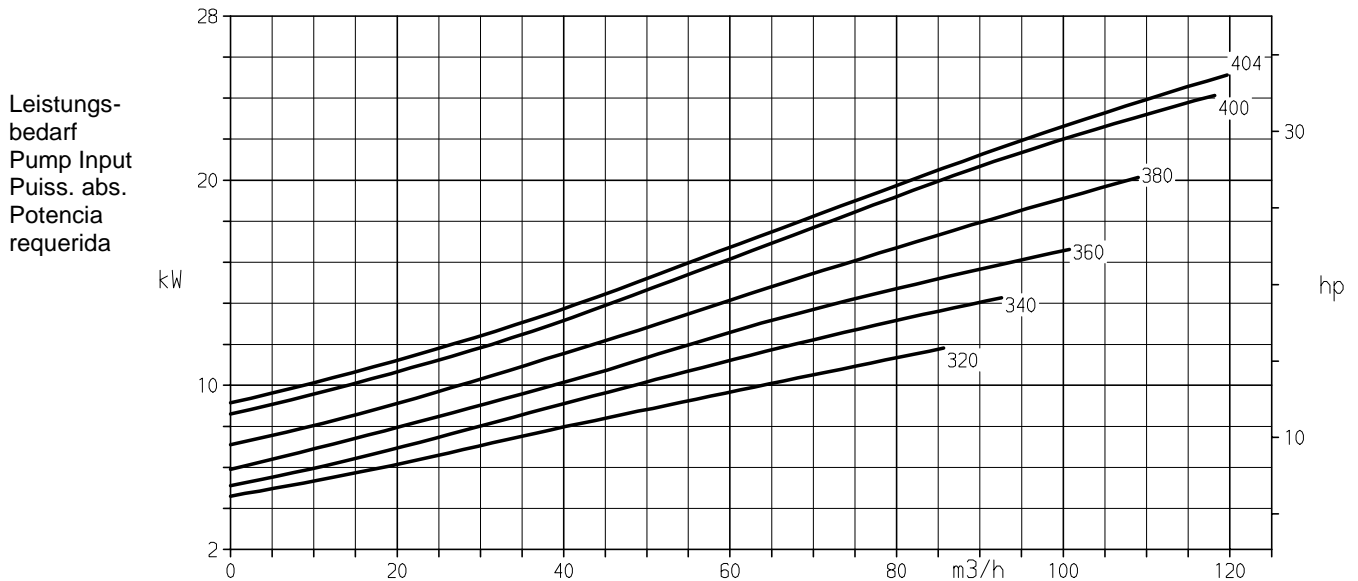
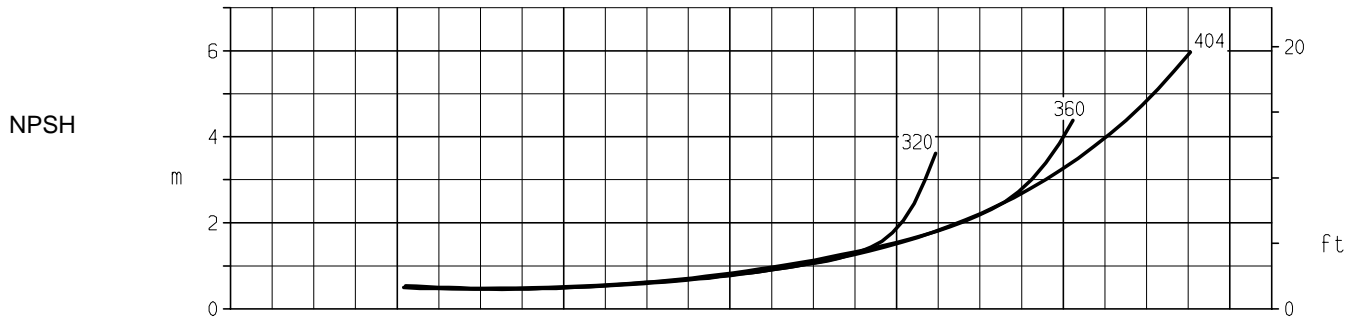
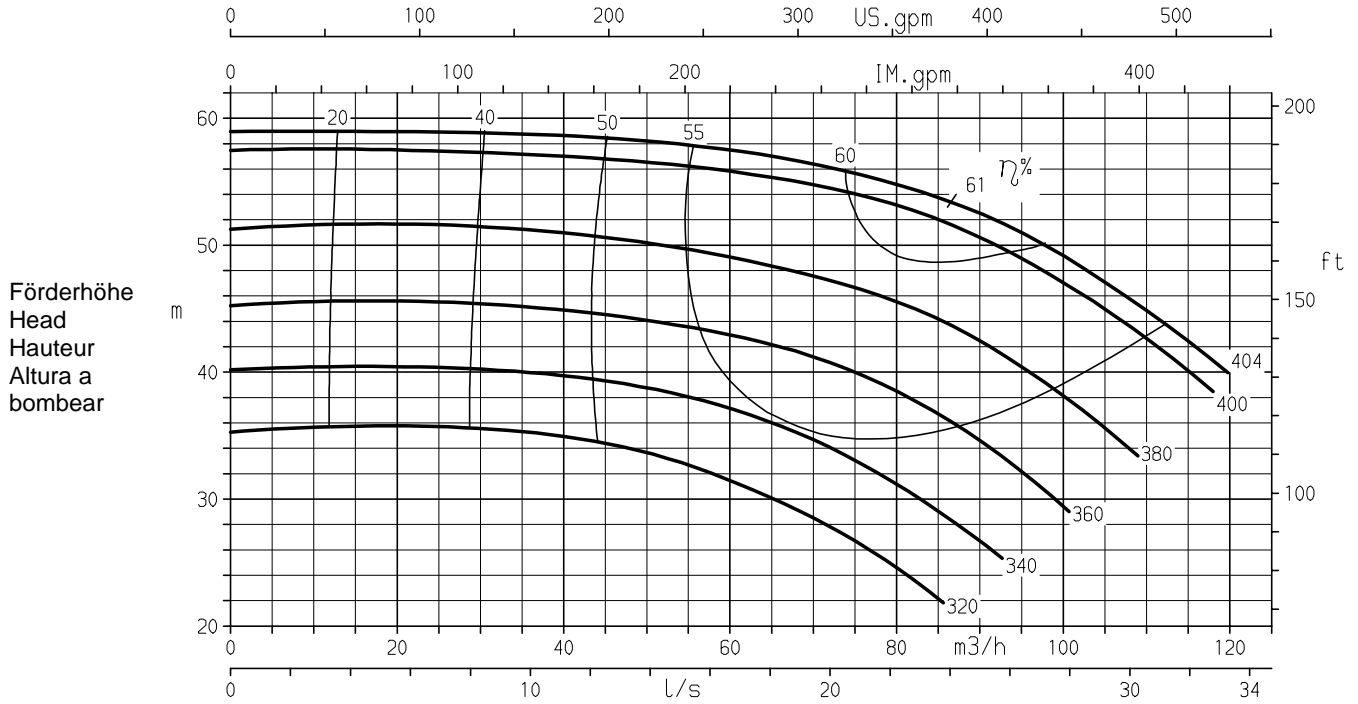

Laufraudaustrittsweite/Impeller outlet width
Largeur à la sortie de la roue/Anchura de salida del rodete

11 mm
11 mm

K 2721.454/356/7

Förderstrom/Capacity/Débit/Caudal

Baureihe Pump type	Modèle Tipo	Nenn Drehzahl Nom. speed	Vitesse nom. Revoluciones nom.	 KSB KSB Aktiengesellschaft Pumpen Industrie- und Wassertechnik Postfach 13 60, D-91253 Pegnitz Bahnhofplatz 1, D-91257
CPK/HPK	100-200	1450 1/min		
Angebots-Nr. Project No.	No. de l'offre Oferta-No.	Pos.-Nr. Item No.	No. de pos. No. de pos.	

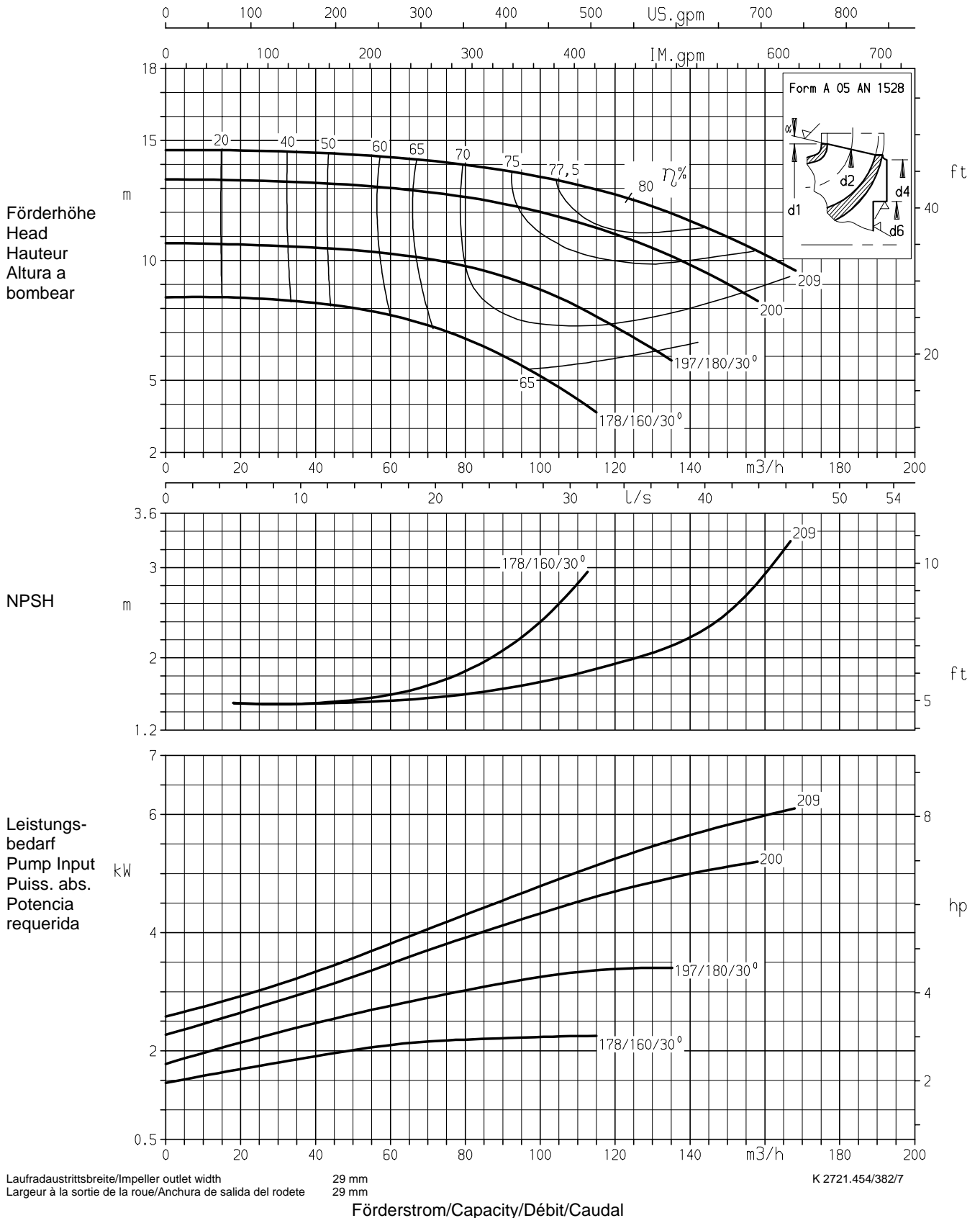

Baureihe Pump type	Modèle Tipo	Nenn Drehzahl Nom. speed	Vitesse nom. Revoluciones nom.	 KSB KSB Aktiengesellschaft Pumpen Industrie- und Wassertechnik Postfach 13 60, D-91253 Pegnitz Bahnhofplatz 1, D-91257
CPK/HPK	100-250	1450 1/min		
Angebots-Nr. Project No.	No. de l'offre Oferta-No.	Pos.-Nr. Item No.	No. de pos. No. de pos.	

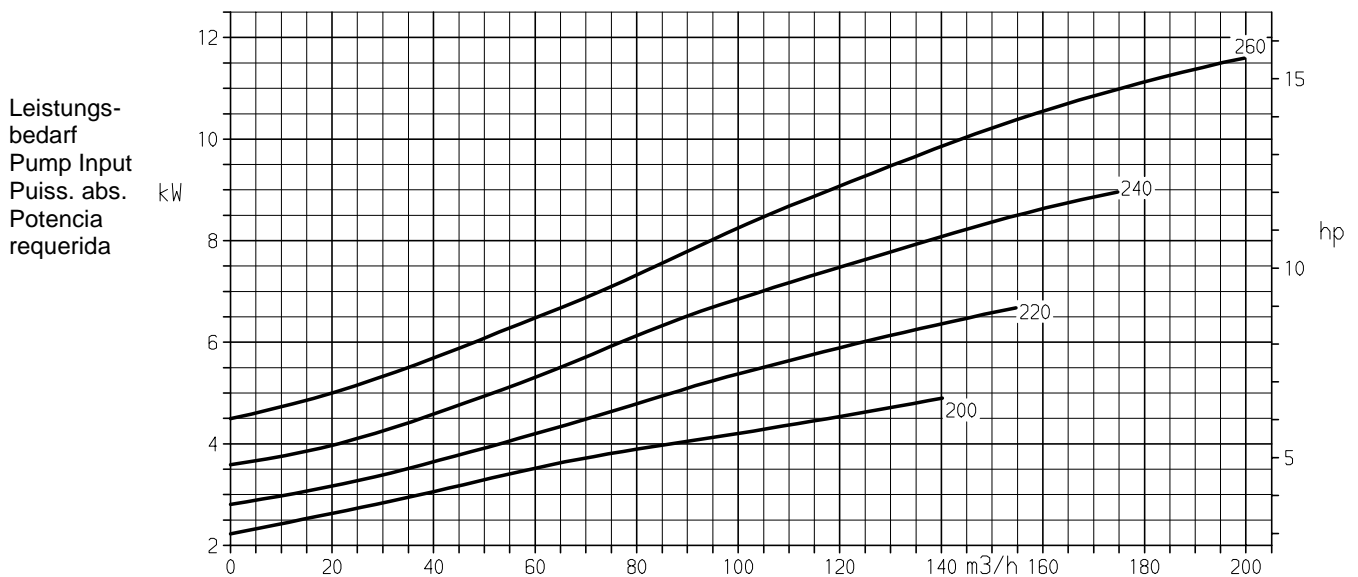
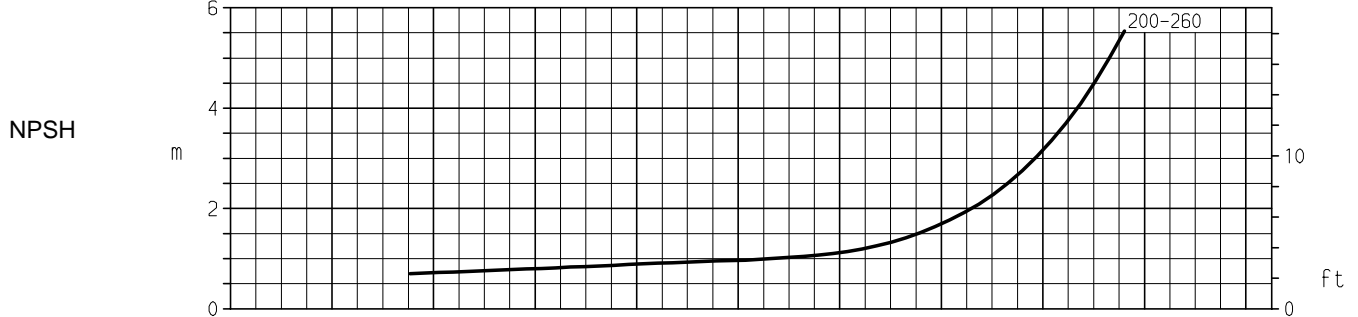
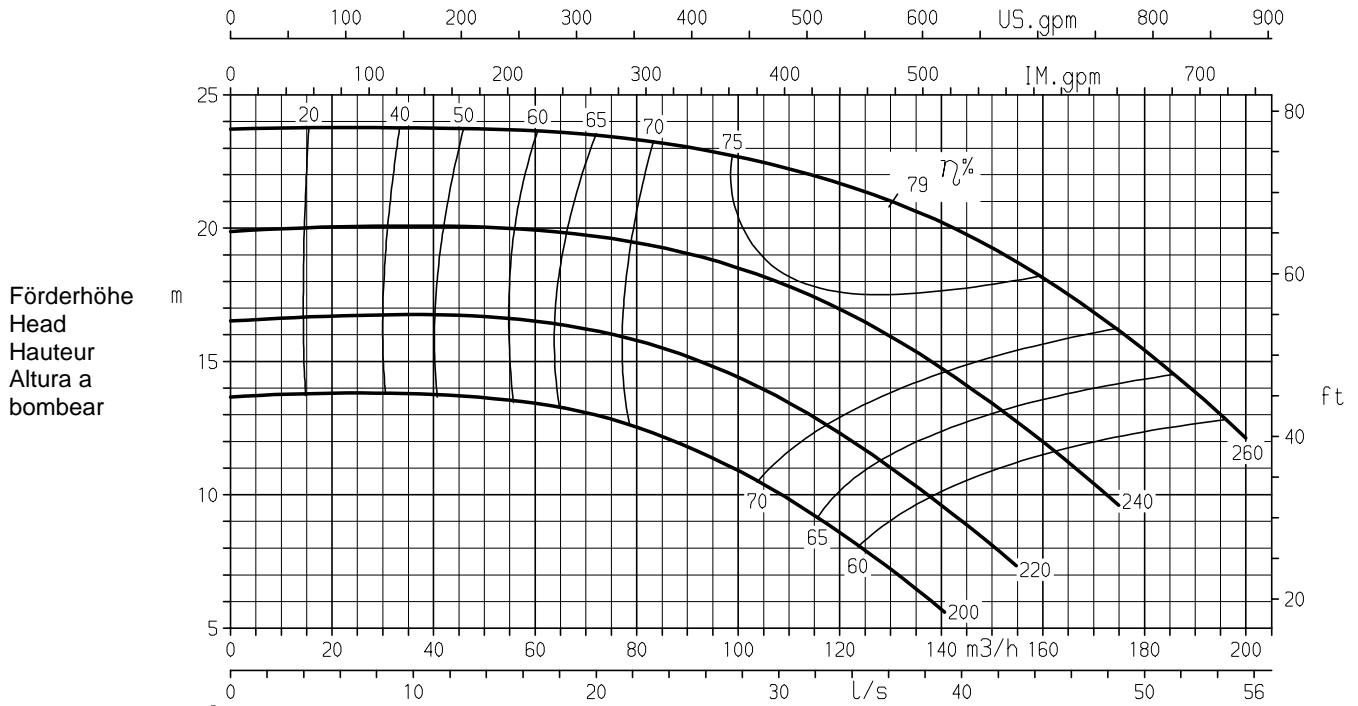

Laufraudaustrittsbreite/Impeller outlet width
Largeur à la sortie de la roue/Anchura de salida del rodete

23 mm
23 mm

K 2721.454/384/7

Förderstrom/Capacity/Débit/Caudal

Baureihe Pump type	Modèle Tipo	Nennzahl Nom. speed	Vitesse nom. Revoluciones nom.	 KSB KSB Aktiengesellschaft Pumpen Industrie- und Wassertechnik Postfach 13 60, D-91253 Pegnitz Bahnhofplatz 1, D-91257
CPK/HPK	100-315	1450 1/min		
Angebots-Nr. Project No.	No. de l'offre Oferta-No.	Pos.-Nr. Item No.	No. de pos. No. de pos.	

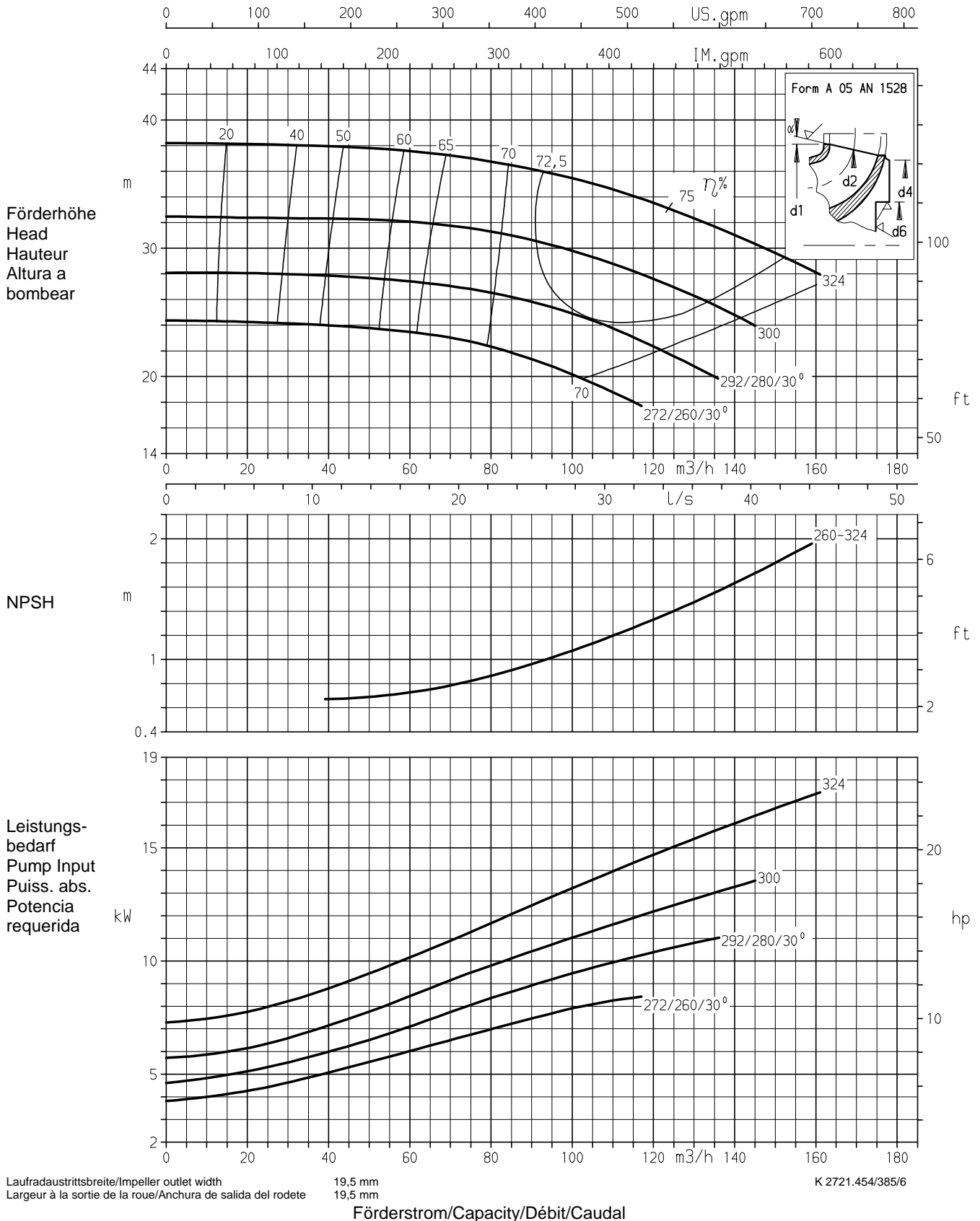

Baureihe Pump type	Modèle Tipo	Nenn Drehzahl Nom. speed	Vitesse nom. Revoluciones nom.	 KSB KSB Aktiengesellschaft Pumpen Industrie- und Wassertechnik Postfach 13 60, D-91253 Pegnitz Bahnhofplatz 1, D-91257
CPK/HPK	100-400	1450 1/min		
Angebots-Nr. Project No.	No. de l'offre Oferta-No.	Pos.-Nr. Item No.	No. de pos. No. de pos.	

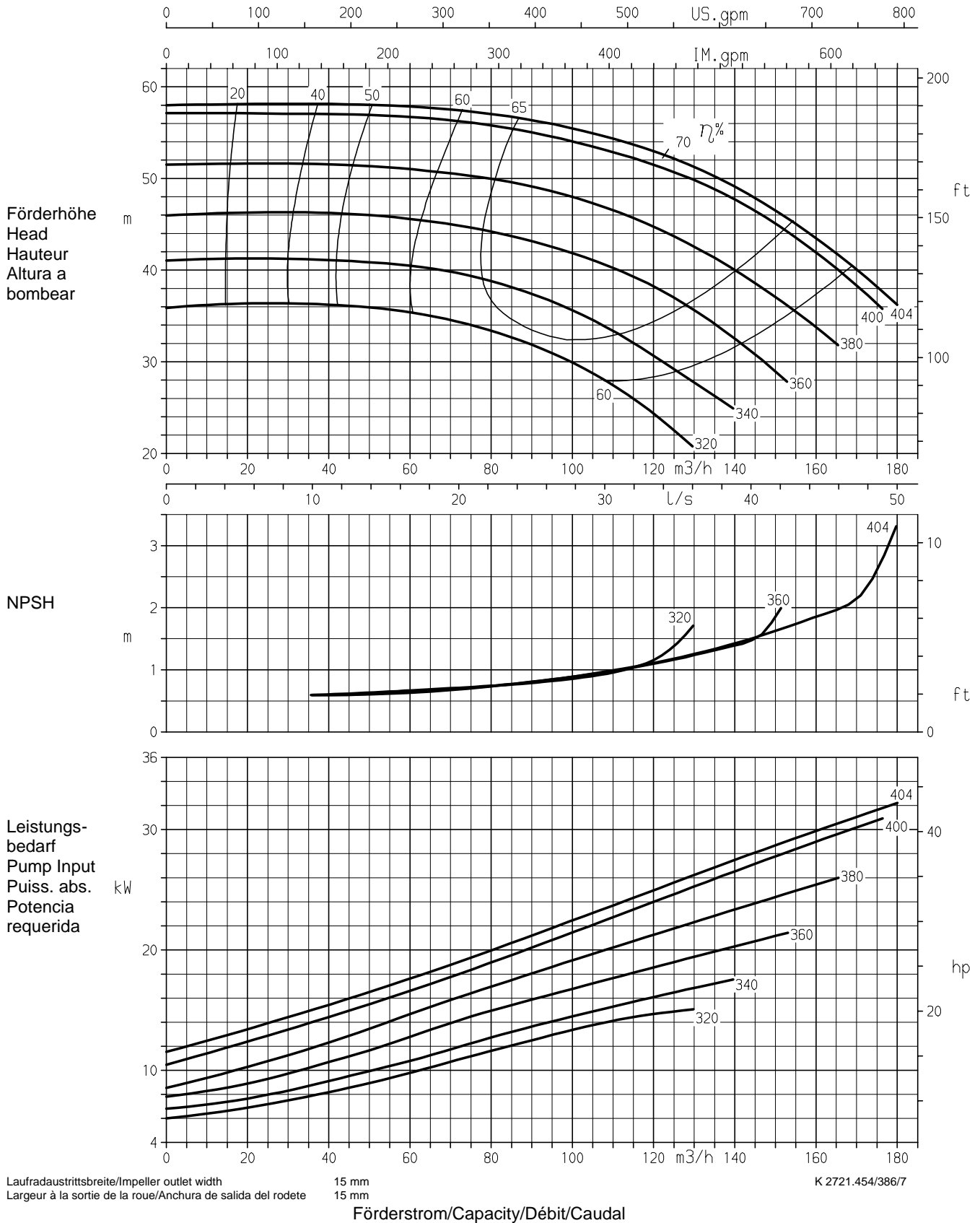

Baureihe Pump type	Modèle Tipo	Nenn Drehzahl Nom. speed	Vitesse nom. Revoluciones nom.	 KSB KSB Aktiengesellschaft Pumpen Industrie- und Wassertechnik Postfach 13 60, D-91253 Pegnitz Bahnhofplatz 1, D-91257
CPK/HPK	125-250	1450 1/min		
Angebots-Nr. Project No.	No. de l'offre Oferta-No.	Pos.-Nr. Item No.	No. de pos. No. de pos.	

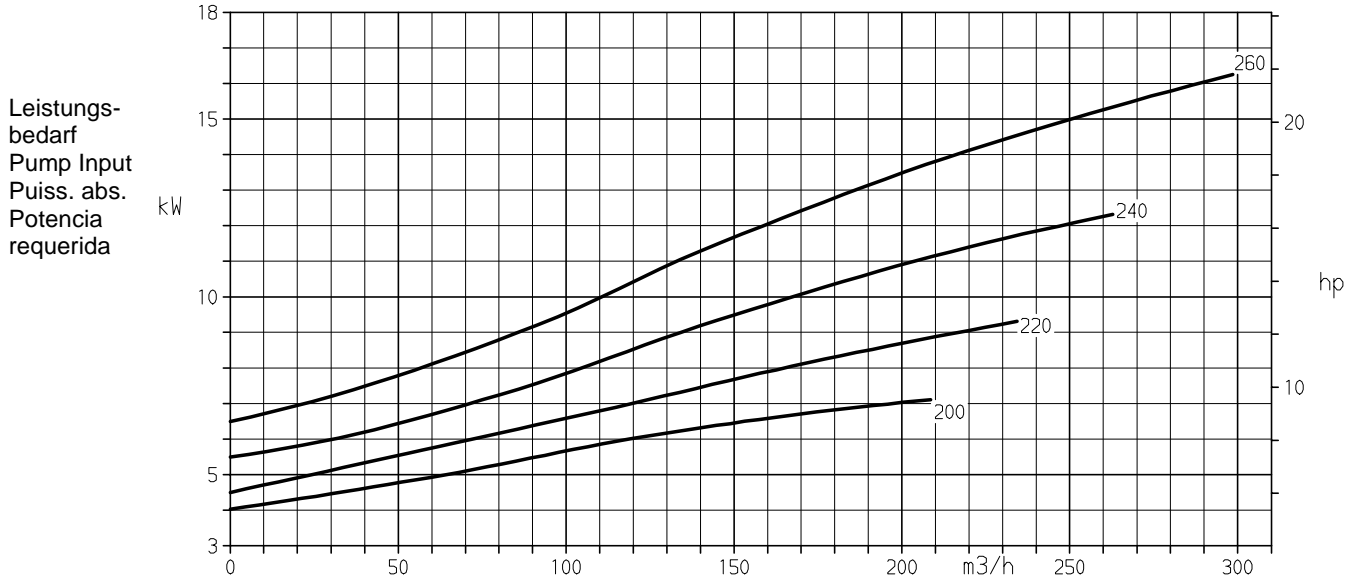
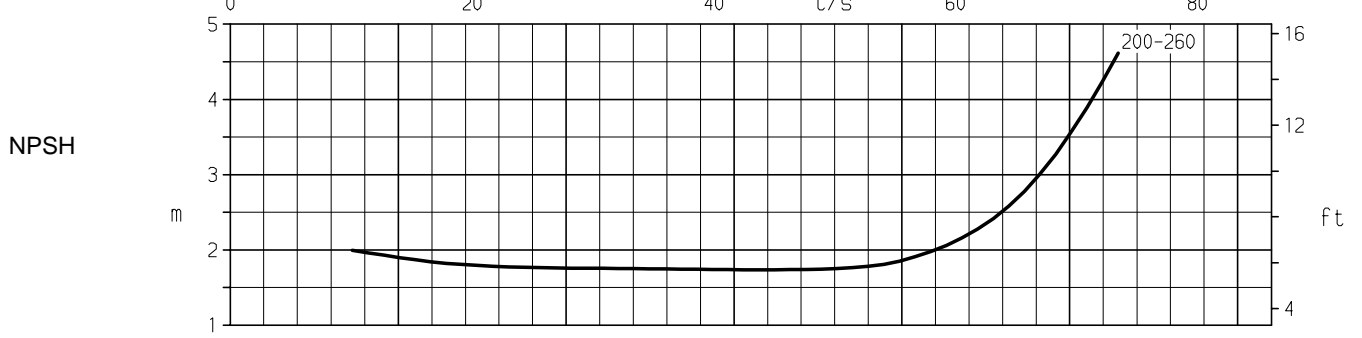
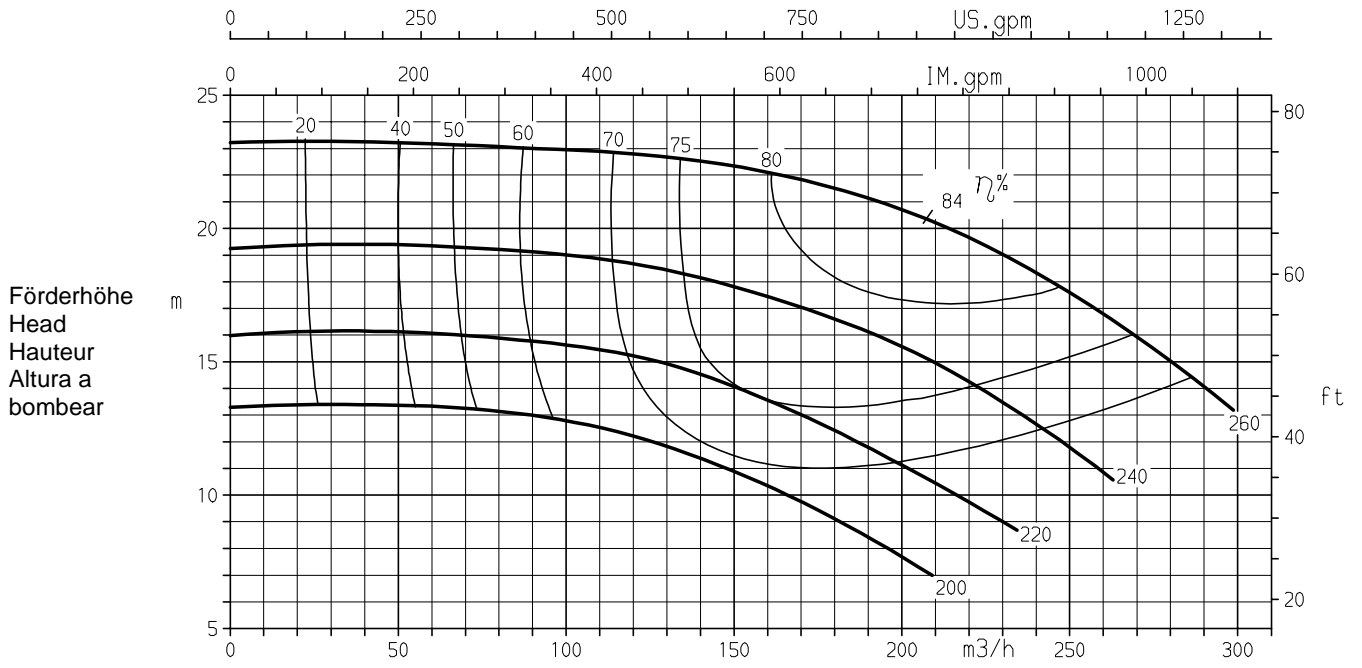

Laufradaustrittsbreite/Impeller outlet width 32 mm
 Largeur à la sortie de la roue/Anchura de salida del rodeté 32 mm
 Förderstrom/Capacity/Débit/Caudal
 K 2721.454/424/7

Baureihe Pump type	Modèle Tipo	Nenndrehzahl Nom. speed	Vitesse nom. Revoluciones nom.	 KSB KSB Aktiengesellschaft Pumpen Industrie- und Wassertechnik Postfach 13 60, D-91253 Pegnitz Bahnhofplatz 1, D-91257
CPK/HPK	125-315	1450 1/min		
Angebots-Nr. Project No.	No. de l'offre Oferta-No.	Pos.-Nr. Item No.	No. de pos. No. de pos.	

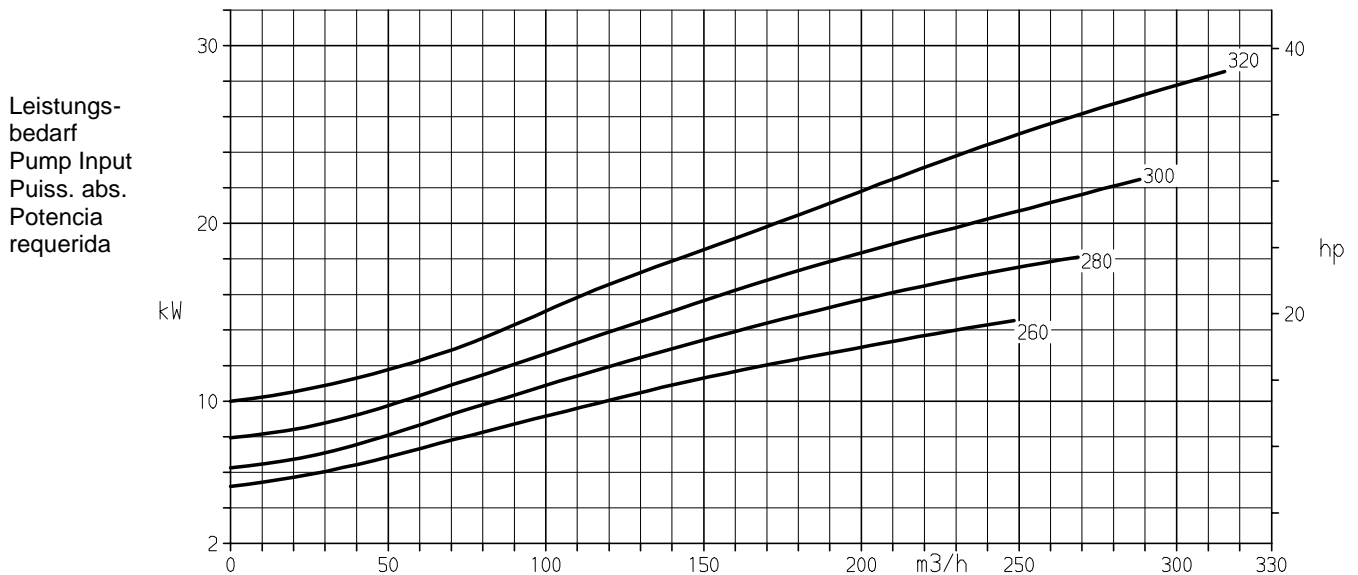
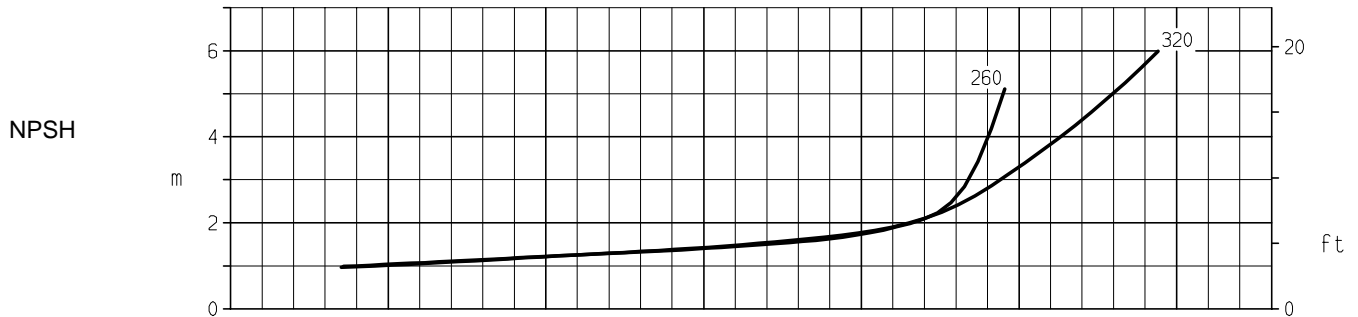
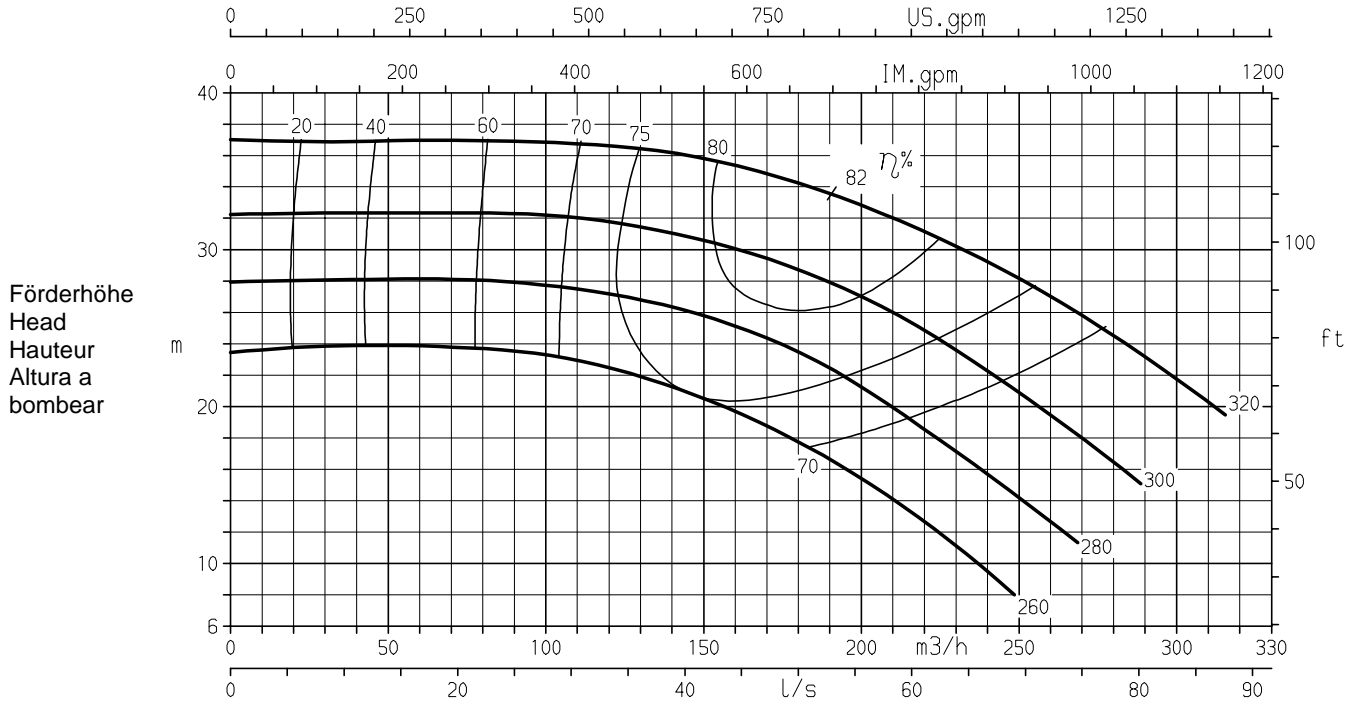

Laufraudastrittsbreite/Impeller outlet width
Largeur à la sortie de la roue/Anchura de salida del rodete

26 mm
26 mm

K 2721.454/425/7

Förderstrom/Capacity/Débit/Caudal

Baureihe Pump type	Modèle Tipo	Nennzahl Nom. speed	Vitesse nom. Revoluciones nom.	 KSB KSB Aktiengesellschaft Pumpen Industrie- und Wassertechnik Postfach 13 60, D-91253 Pegnitz Bahnhofplatz 1, D-91257
CPK/HPK	125-400	1450 1/min		
Angebots-Nr. Project No.	No. de l'offre Oferta-No.	Pos.-Nr. Item No.	No. de pos. No. de pos.	

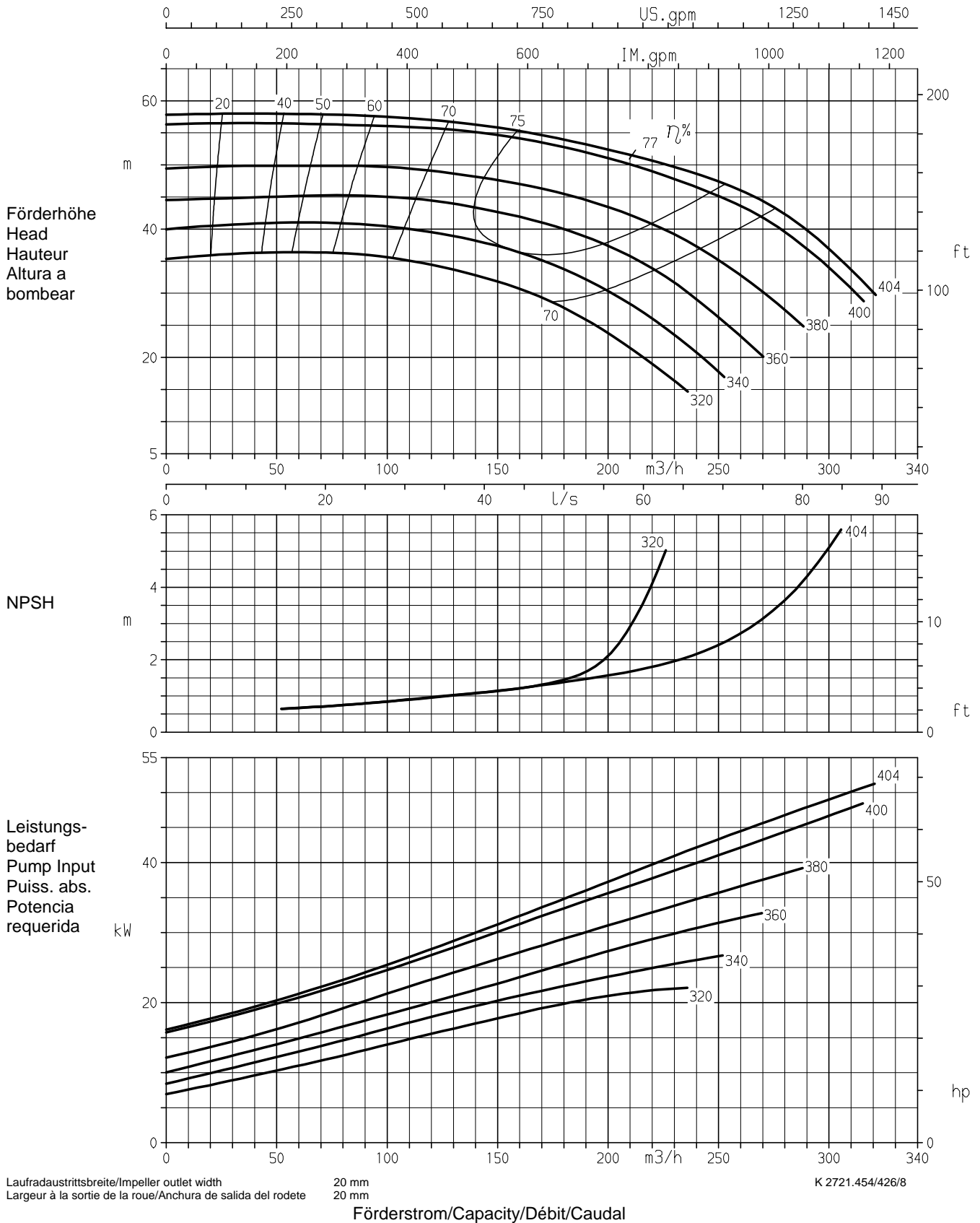

Baureihe Pump type	Modèle Tipo	Nenn Drehzahl Nom. speed	Vitesse nom. Revoluciones nom.	 KSB KSB Aktiengesellschaft Pumpen Industrie- und Wassertechnik Postfach 13 60, D-91253 Pegnitz Bahnhofplatz 1, D-91257
CPK/HPK	150-250	1450 1/min		
Angebots-Nr. Project No.	No. de l'offre Oferta-No.	Pos.-Nr. Item No.	No. de pos. No. de pos.	

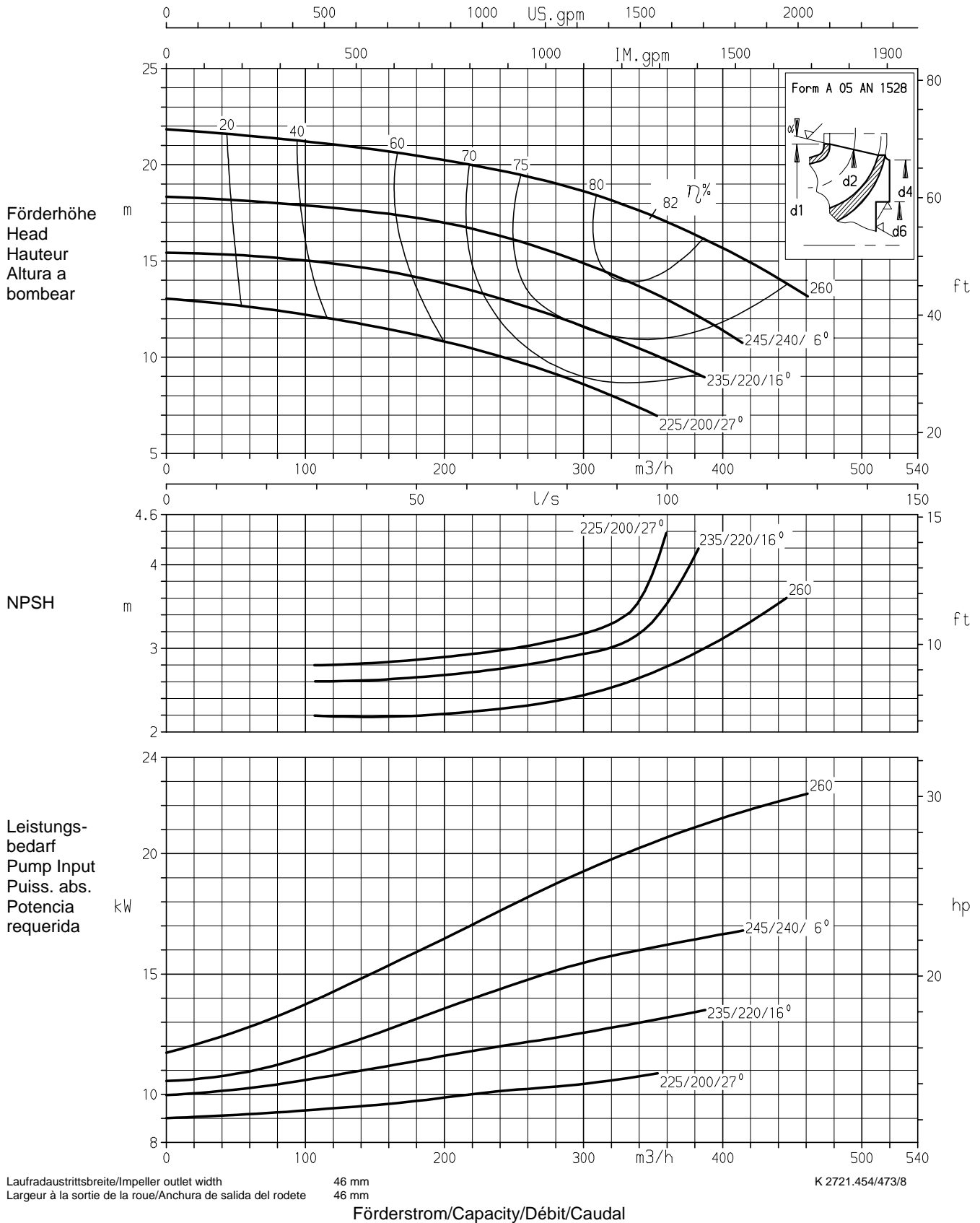

Baureihe Pump type	Modèle Tipo	Nenn Drehzahl Nom. speed	Vitesse nom. Revoluciones nom.	 KSB KSB Aktiengesellschaft Pumpen Industrie- und Wassertechnik Postfach 13 60, D-91253 Pegnitz Bahnhofplatz 1, D-91257
CPK/HPK	150-315	1450 1/min		
Angebots-Nr. Project No.	No. de l'offre Oferta-No.	Pos.-Nr. Item No.	No. de pos. No. de pos.	

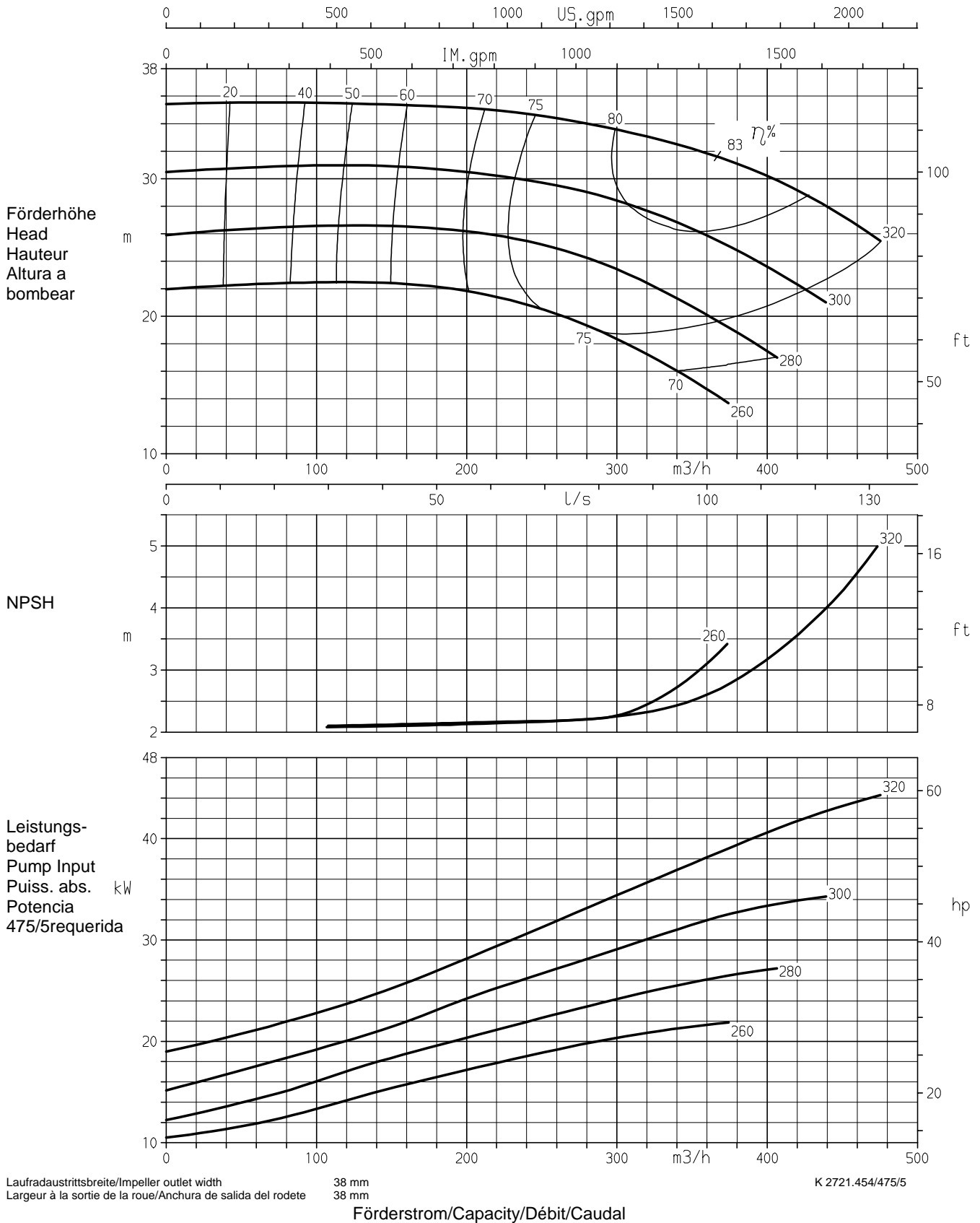

Baureihe Pump type	Modèle Tipo	Nenn Drehzahl Nom. speed	Vitesse nom. Revoluciones nom.	 KSB KSB Aktiengesellschaft Pumpen Industrie- und Wassertechnik Postfach 13 60, D-91253 Pegnitz Bahnhofplatz 1, D-91257
CPK/HPK	150-400	1450 1/min		
Angebots-Nr. Project No.	No. de l'offre Oferta-No.	Pos.-Nr. Item No.	No. de pos. No. de pos.	

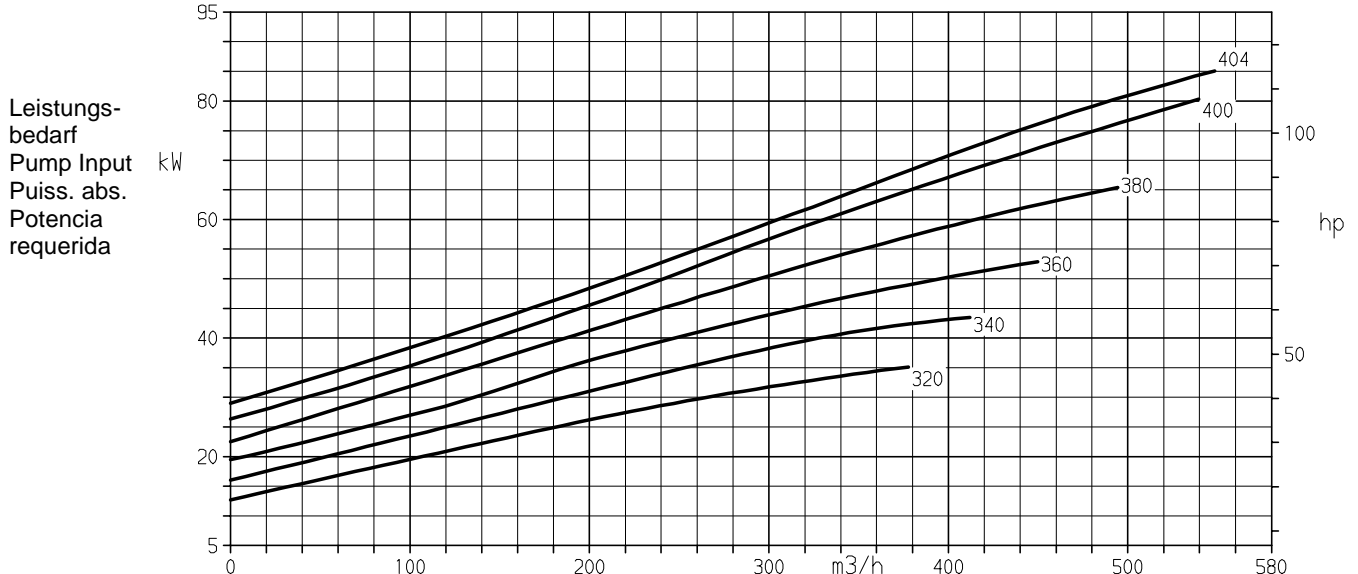
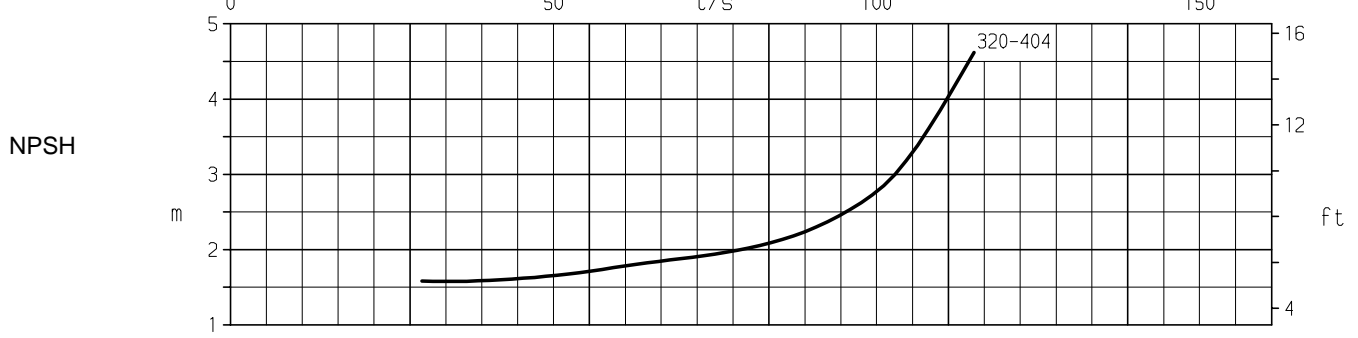
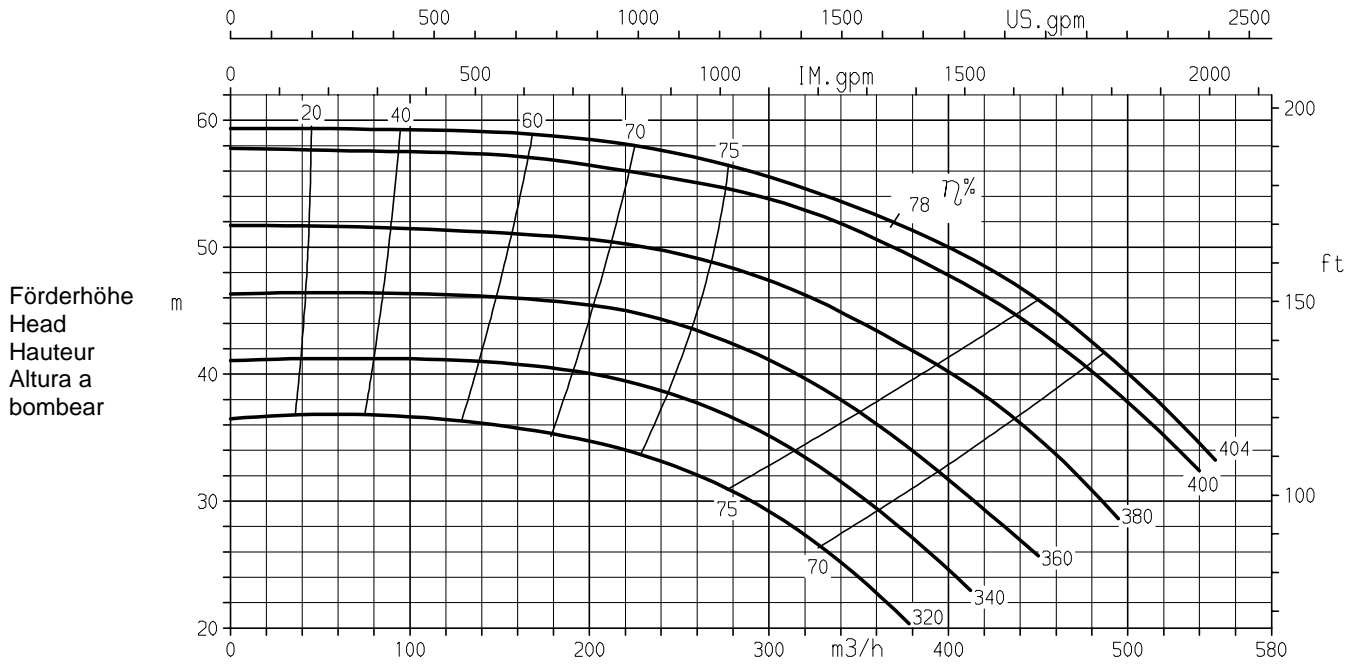

Laufraudaustrittsbreite/Impeller outlet width
Largeur à la sortie de la roue/Anchura de salida del rodete

29 mm
29 mm

K 2721.454/476/7

Förderstrom/Capacity/Débit/Caudal

Baureihe Pump type	Modèle Tipo	Nennzahl Nom. speed	Vitesse nom. Revoluciones nom.	 KSB KSB Aktiengesellschaft Pumpen Industrie- und Wassertechnik Postfach 13 60, D-91253 Pegnitz Bahnhofplatz 1, D-91257
CPK/HPK	150-500	1450 1/min		
Angebots-Nr. Project No.	No. de l'offre Oferta-No.	Pos.-Nr. Item No.	No. de pos. No. de pos.	

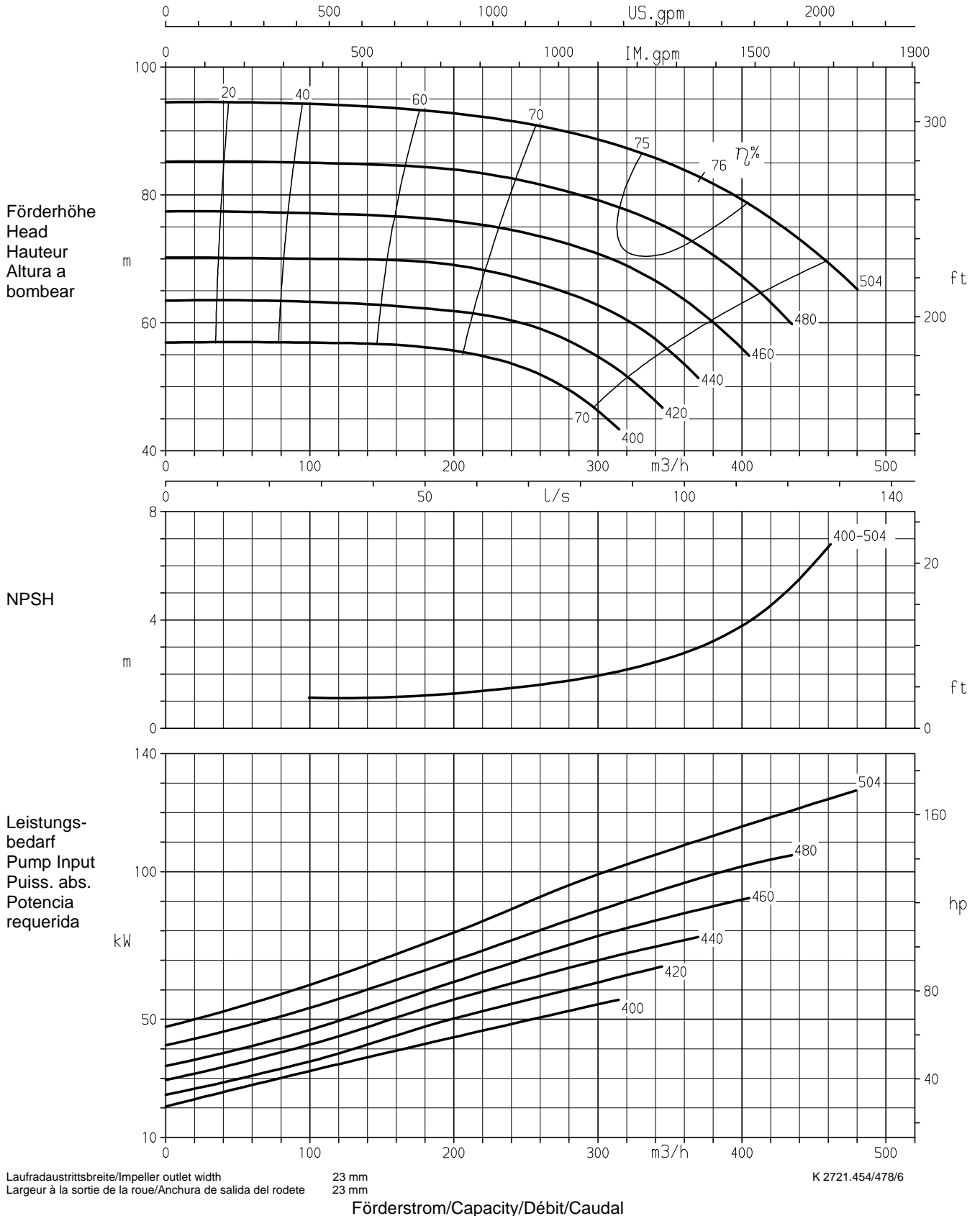

Baureihe Pump type	Modèle Tipo	Neendrehzahl Nom. speed	Vitesse nom. Revoluciones nom.	 KSB KSB Aktiengesellschaft Pumpen Industrie- und Wassertechnik Postfach 13 60, D-91253 Pegnitz Bahnhofplatz 1, D-91257
CPK/HPK	200-250	1450 1/min		
Angebots-Nr. Project No.	No. de l'offre Oferta-No.	Pos.-Nr. Item No.	No. de pos. No. de pos.	

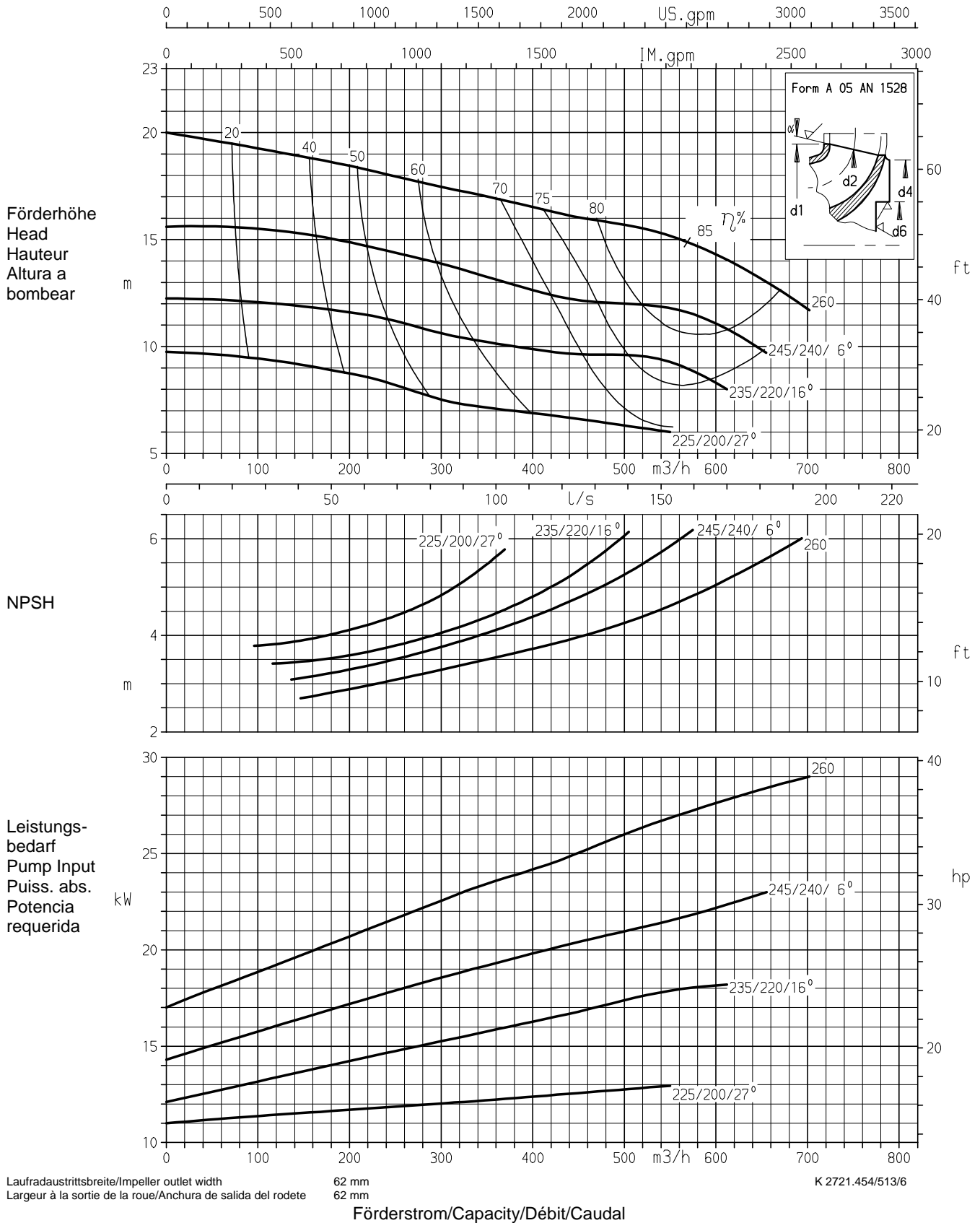

Baureihe Pump type	Modèle Tipo	Nenn Drehzahl Nom. speed	Vitesse nom. Revoluciones nom.	 KSB KSB Aktiengesellschaft Pumpen Industrie- und Wassertechnik Postfach 13 60, D-91253 Pegnitz Bahnhofplatz 1, D-91257
CPK/HPK	200-315	1450 1/min		
Angebots-Nr. Project No.	No. de l'offre Oferta-No.	Pos.-Nr. Item No.	No. de pos. No. de pos.	

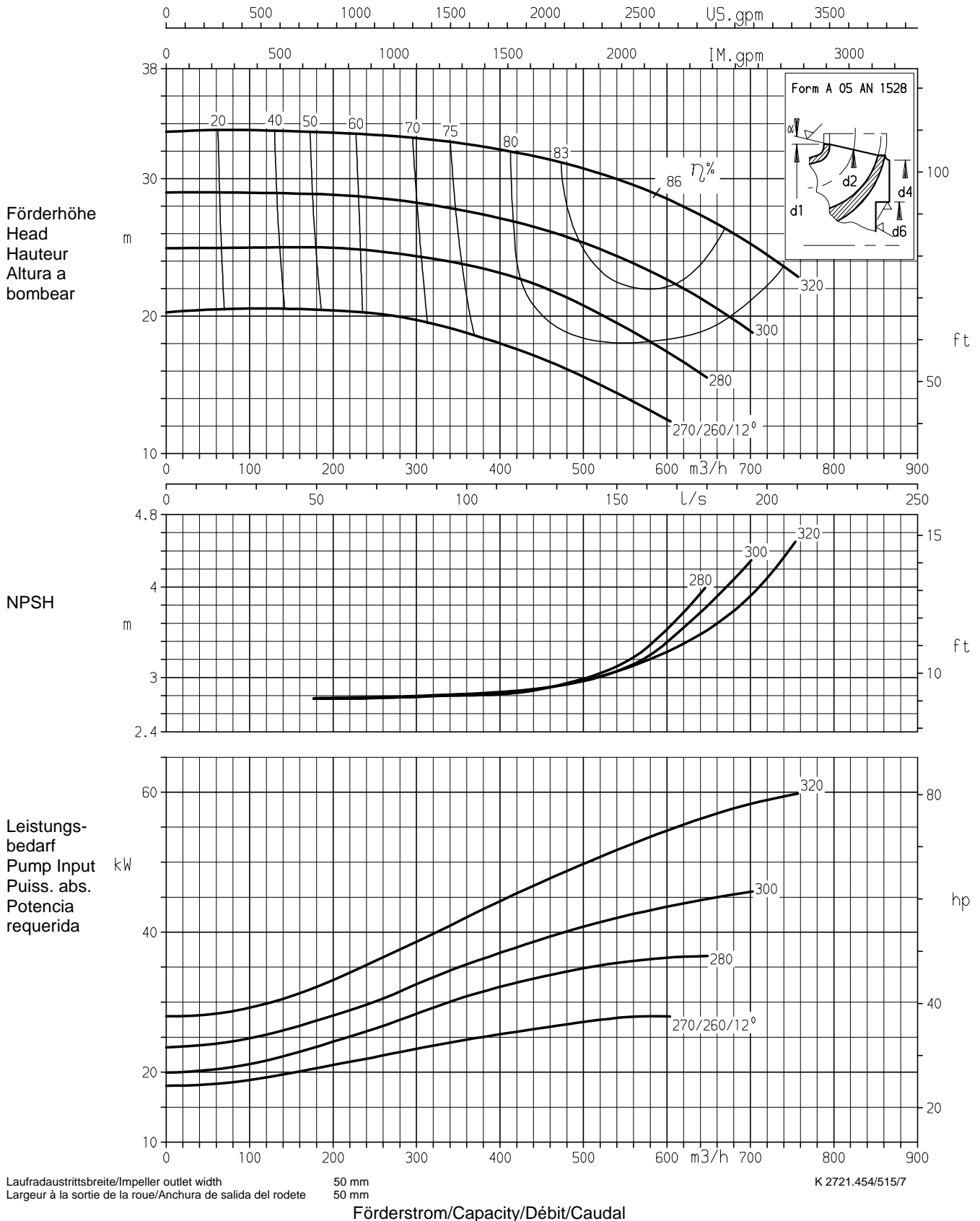

Baureihe Pump type	Modèle Tipo	Nenndrehzahl Nom. speed	Vitesse nom. Revoluciones nom.	 KSB KSB Aktiengesellschaft Pumpen Industrie- und Wassertechnik Postfach 13 60, D-91253 Pegnitz Bahnhofplatz 1, D-91257
CPK/HPK	200-400	1450 1/min		
Angebots-Nr. Project No.	No. de l'offre Oferta-No.	Pos.-Nr. Item No.	No. de pos. No. de pos.	

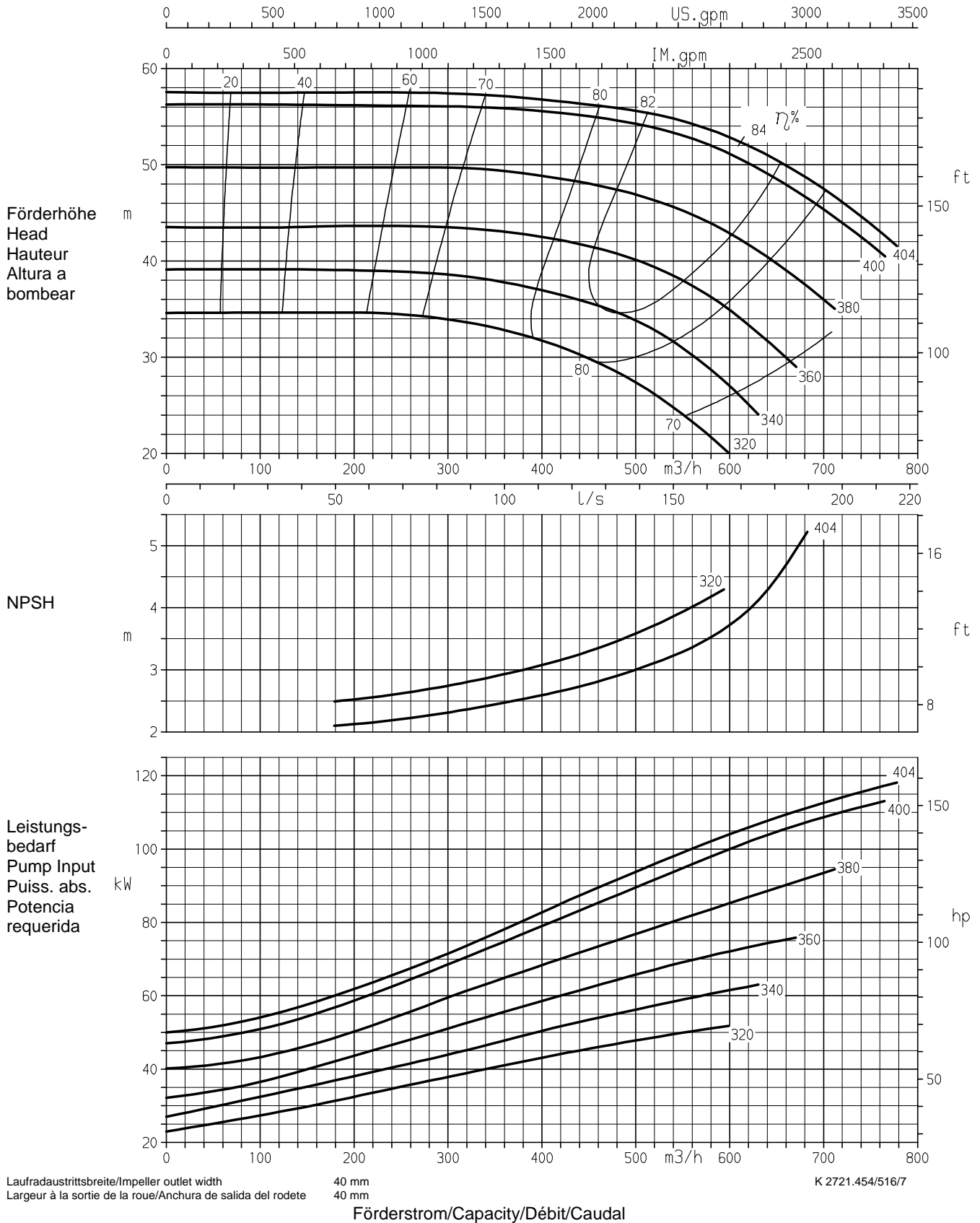

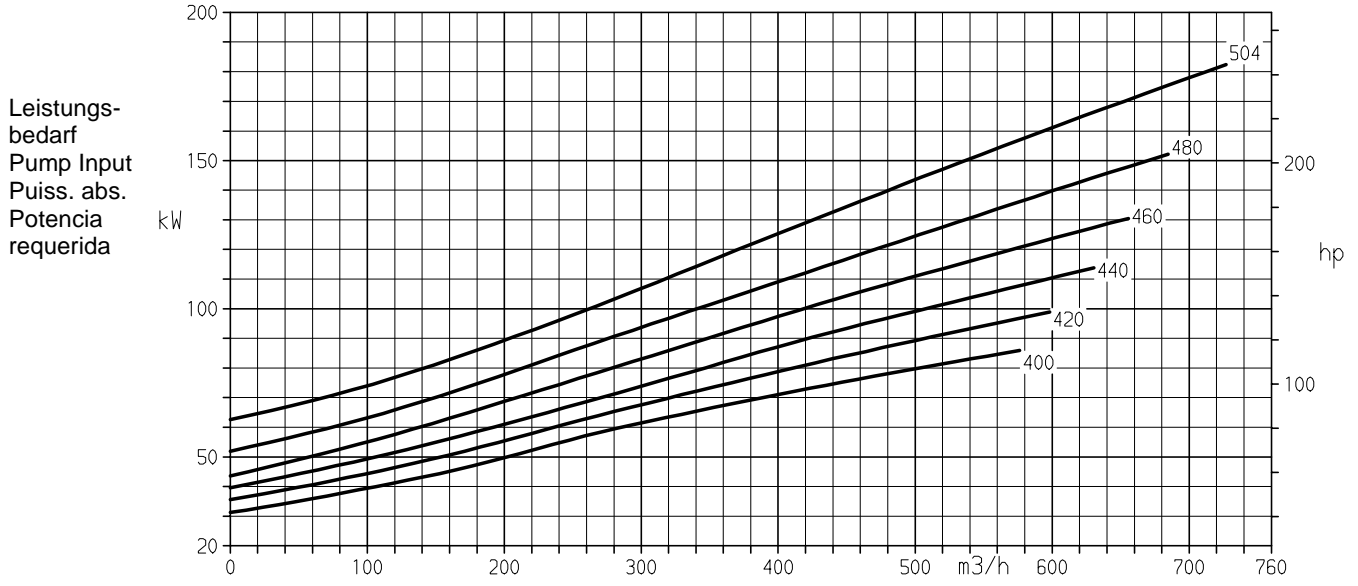
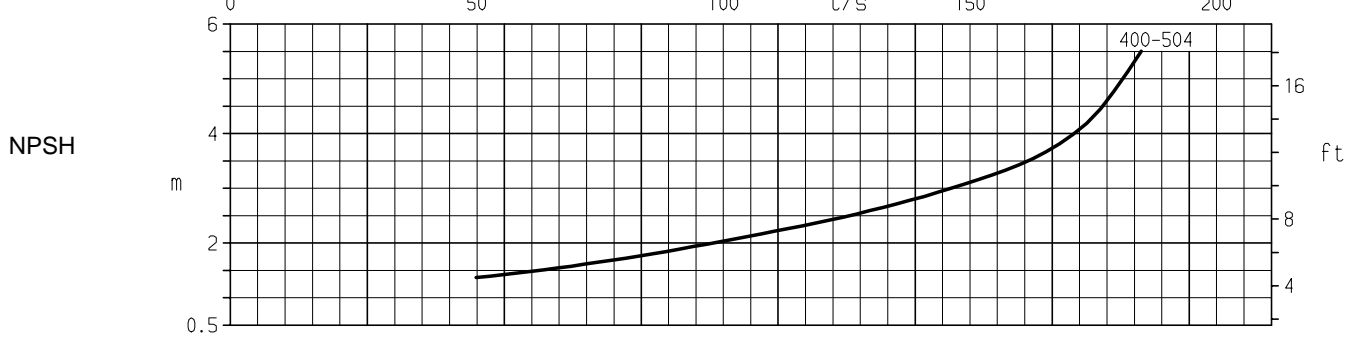
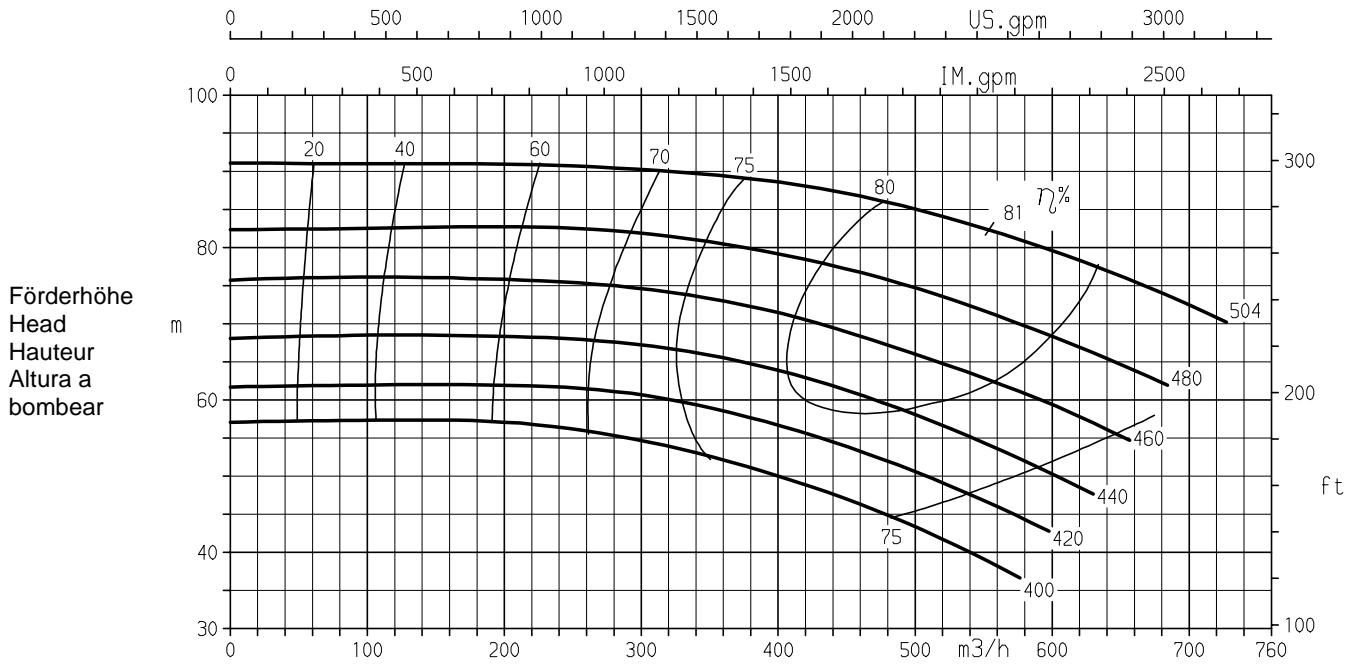

Baureihe Pump type	Modèle Tipo	Nennzahl Nom. speed	Vitesse nom. Revoluciones nom.	 KSB KSB Aktiengesellschaft Pumpen Industrie- und Wassertechnik Postfach 13 60, D-91253 Pegnitz Bahnhofplatz 1, D-91257
CPK/HPK	200-500	1450 1/min		
Angebots-Nr. Project No.	No. de l'offre Oferta-No.	Pos.-Nr. Item No.	No. de pos. No. de pos.	

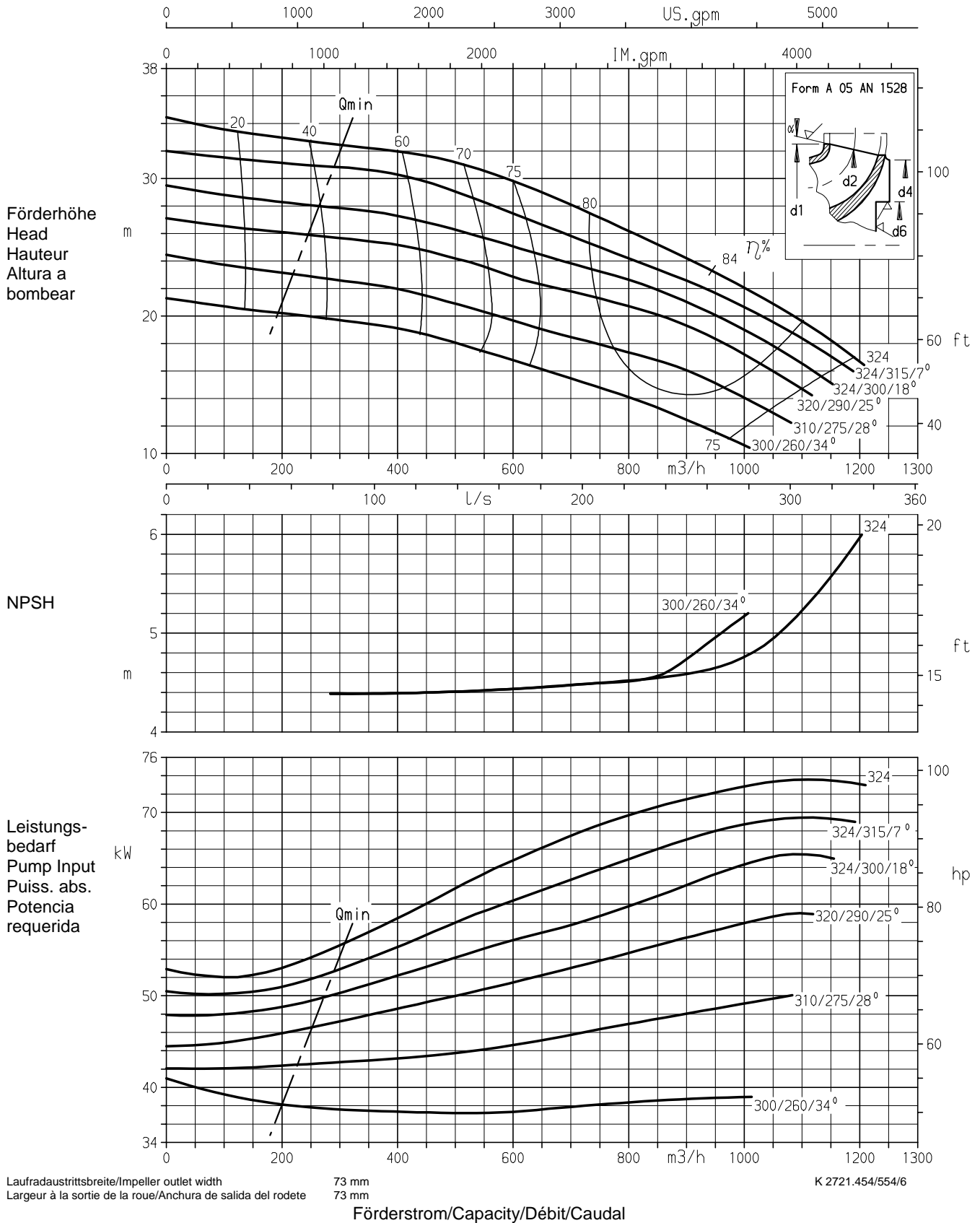

Laufraustrittsbreite/Impeller outlet width 32 mm
 Largeur à la sortie de la roue/Anchura de salida del rodeté 32 mm
 Förderstrom/Capacity/Débit/Caudal K 2721.454/518/5

Baureihe Pump type	Modèle Tipo	Nenn Drehzahl Nom. speed	Vitesse nom. Revoluciones nom.	 KSB KSB Aktiengesellschaft Pumpen Industrie- und Wassertechnik Postfach 13 60, D-91253 Pegnitz Bahnhofplatz 1, D-91257
CPK/HPK	250-315	1450 1/min		
Angebots-Nr. Project No.	No. de l'offre Oferta-No.	Pos.-Nr. Item No.	No. de pos. No. de pos.	



Baureihe Pump type	Modèle Tipo	Neendrehzahl Nom. speed	Vitesse nom. Revoluciones nom.	 KSB KSB Aktiengesellschaft Pumpen Industrie- und Wassertechnik Postfach 13 60, D-91253 Pegnitz Bahnhofplatz 1, D-91257
CPK/HPK	250-400	1450 1/min		
Angebots-Nr. Project No.	No. de l'offre Oferta-No.	Pos.-Nr. Item No.	No. de pos. No. de pos.	

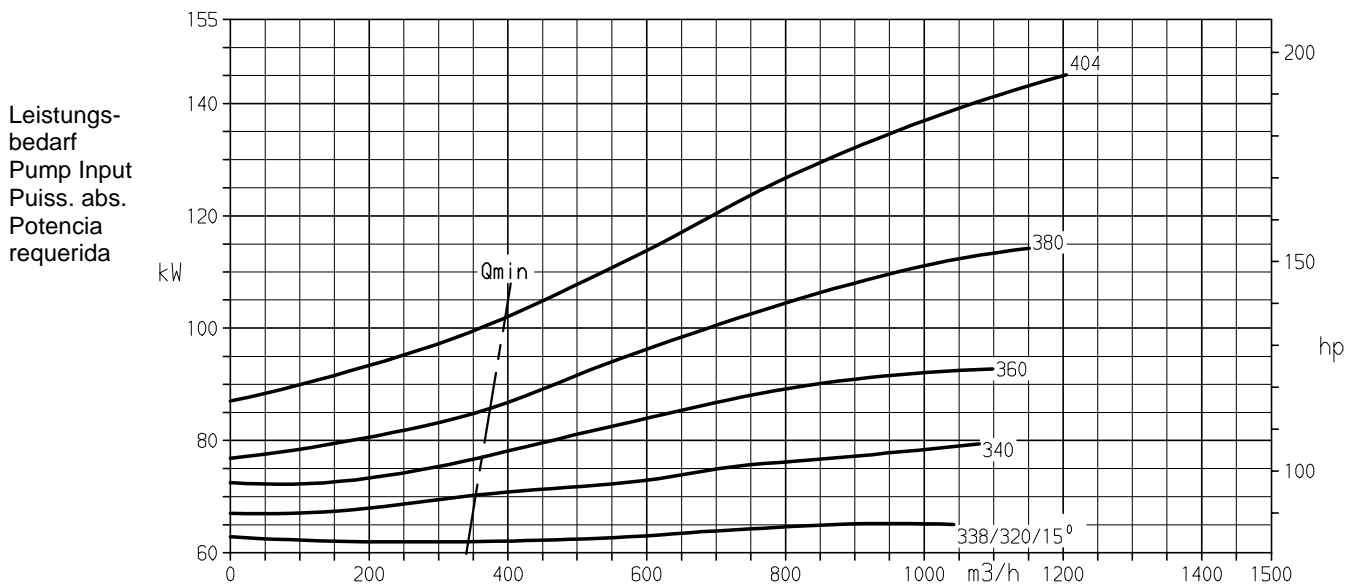
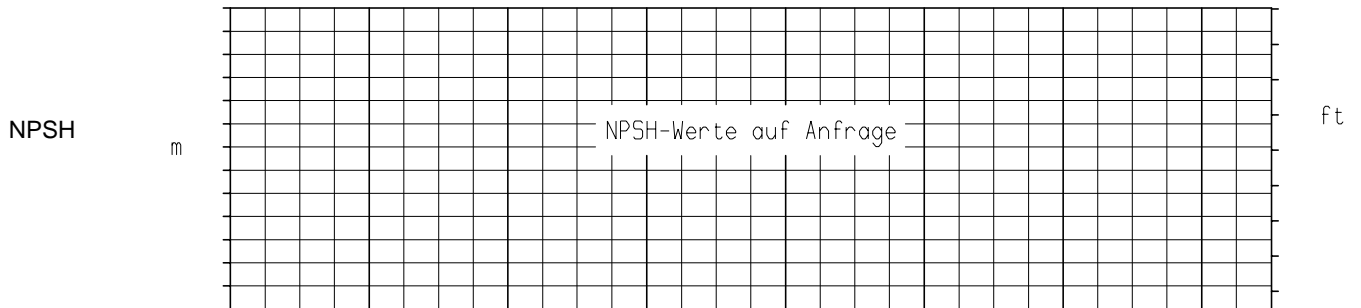
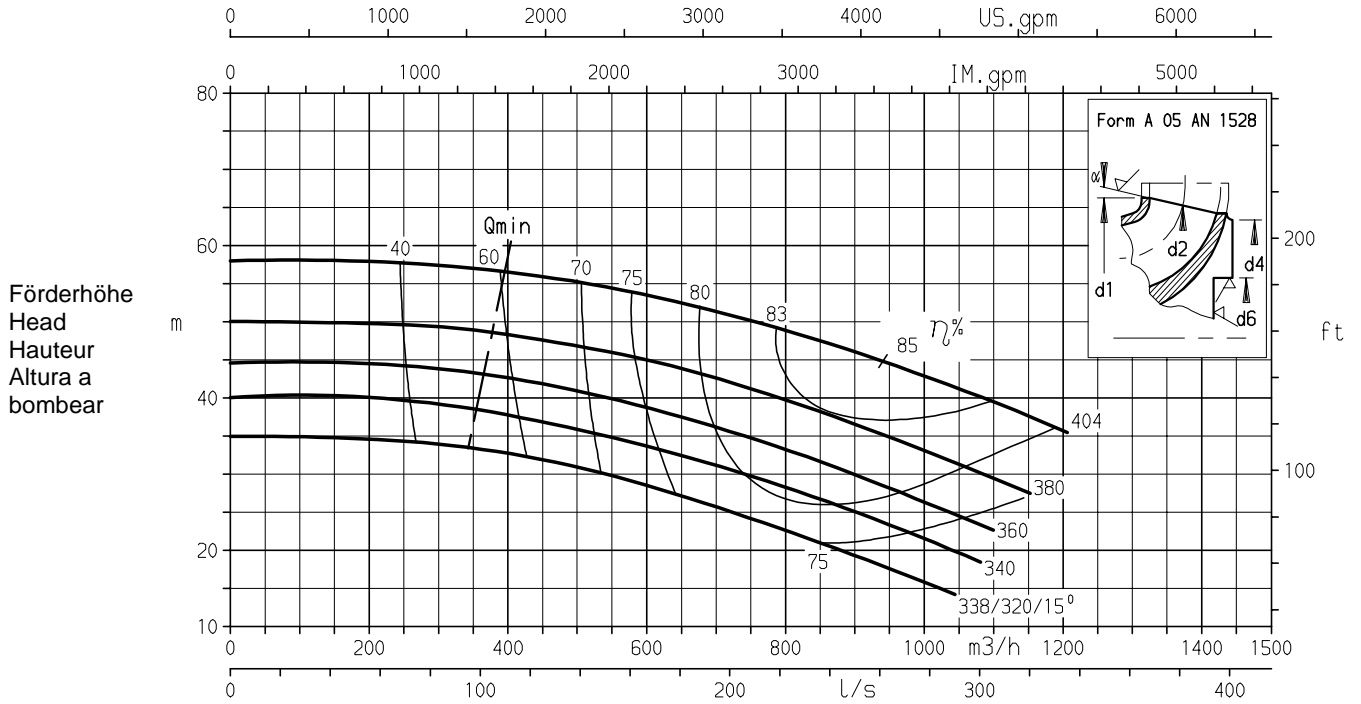

Laufradaustrittsbreite/Impeller outlet width
Largeur à la sortie de la roue/Anchura de salida del rodeté

63 mm
63 mm

K 2721.454/556/6

Förderstrom/Capacity/Débit/Caudal

Baureihe Pump type	Modèle Tipo	Nenn Drehzahl Nom. speed	Vitesse nom. Revoluciones nom.	 KSB KSB Aktiengesellschaft Pumpen Industrie- und Wassertechnik Postfach 13 60, D-91253 Pegnitz Bahnhofplatz 1, D-91257
CPK/HPK	250-500	1450 1/min		
Angebots-Nr. Project No.	No. de l'offre Oferta-No.	Pos.-Nr. Item No.	No. de pos. No. de pos.	

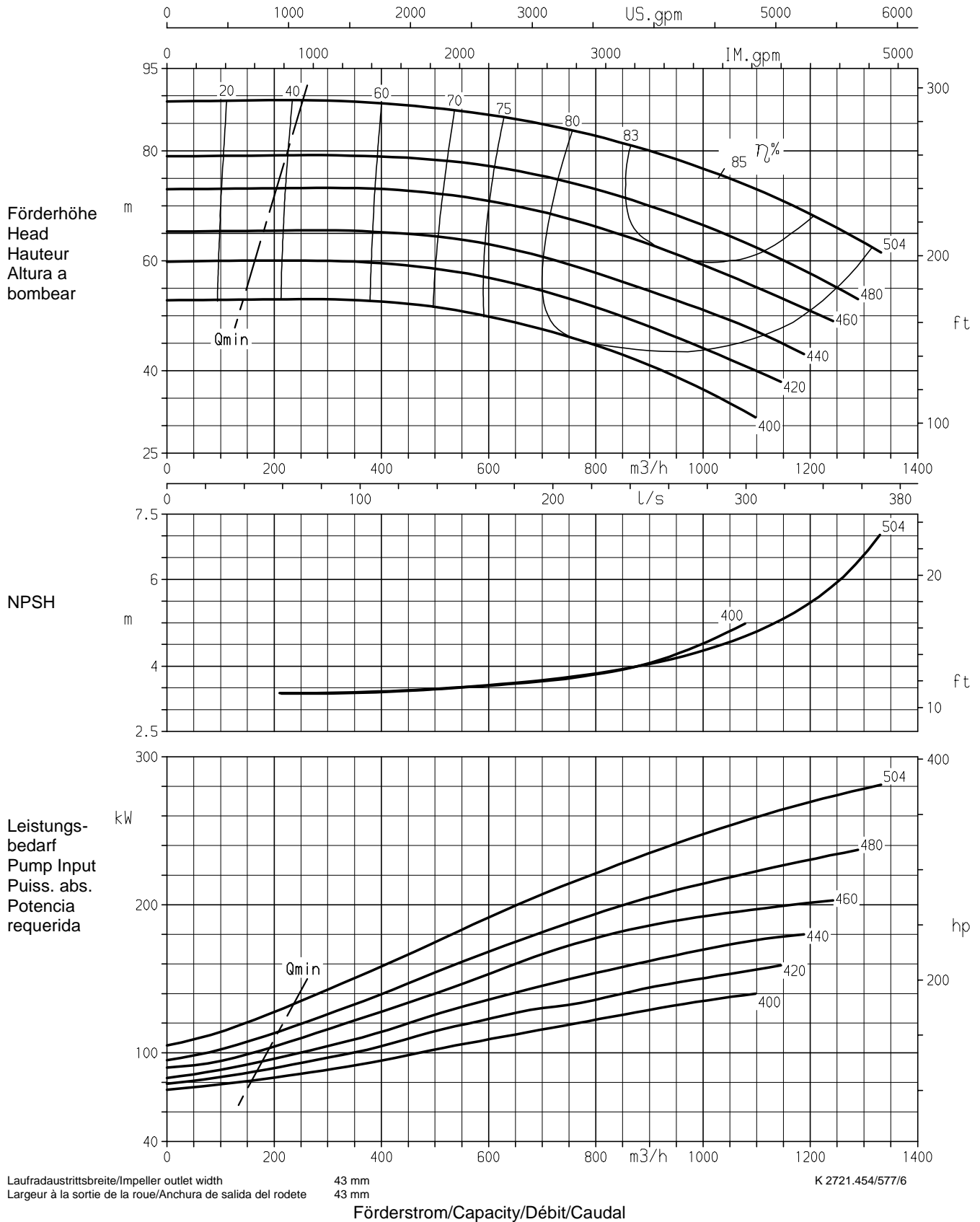

Baureihe Pump type CPK/HPK A-Rad	Modèle Tipo 300-400	Nennndrehzahl Nom. speed 1450 1/min	Vitesse nom. Revoluciones nom.	 KSB KSB Aktiengesellschaft Pumpen Industrie- und Wassertechnik Postfach 13 60, D-91253 Pegnitz Bahnhofplatz 1, D-91257
Angebots-Nr. Project No.	No. de l'offre Oferta-No.	Pos.-Nr. Item No.	No. de pos. No. de pos.	

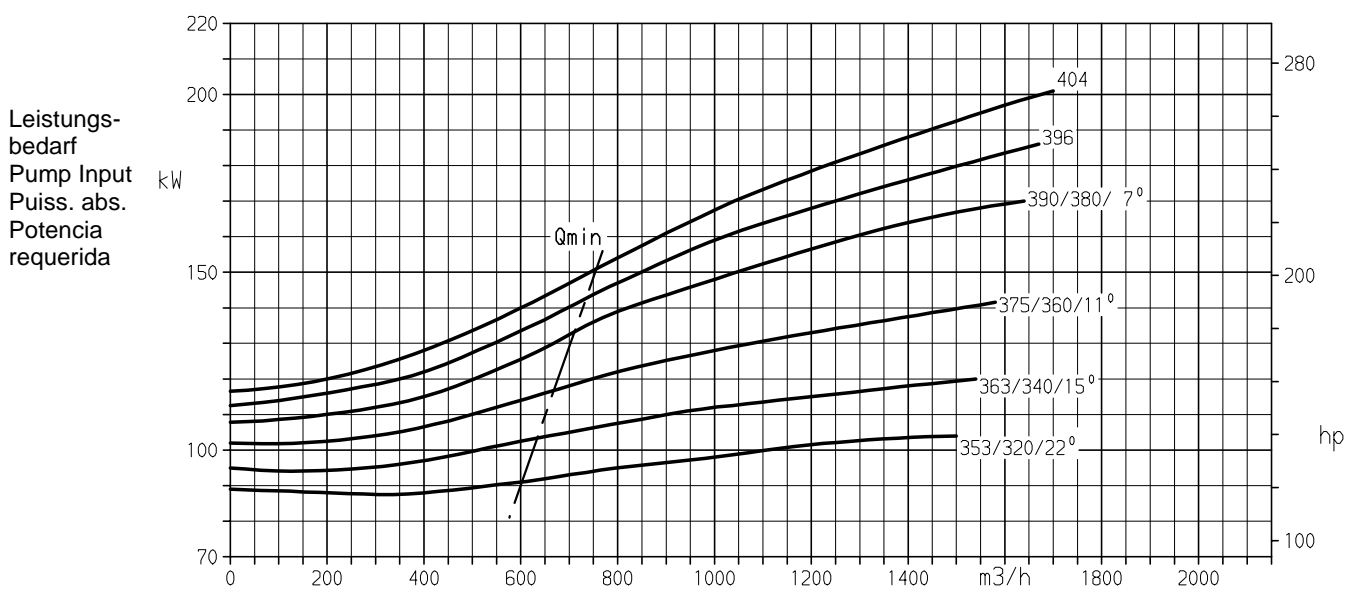
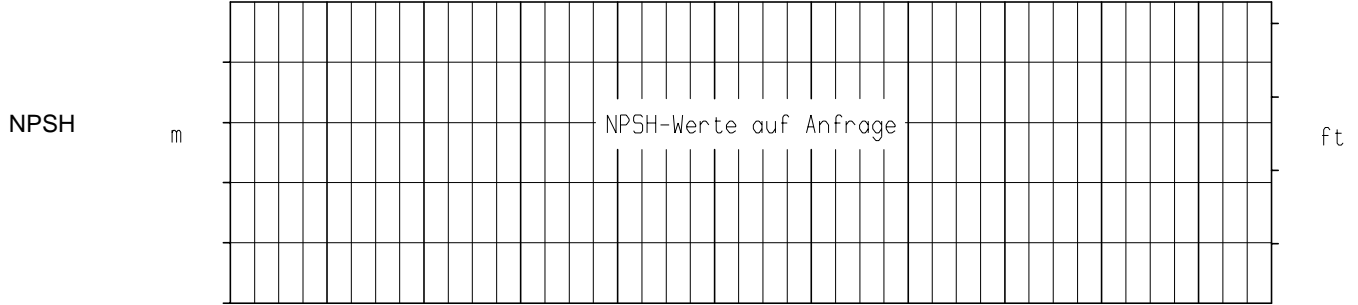
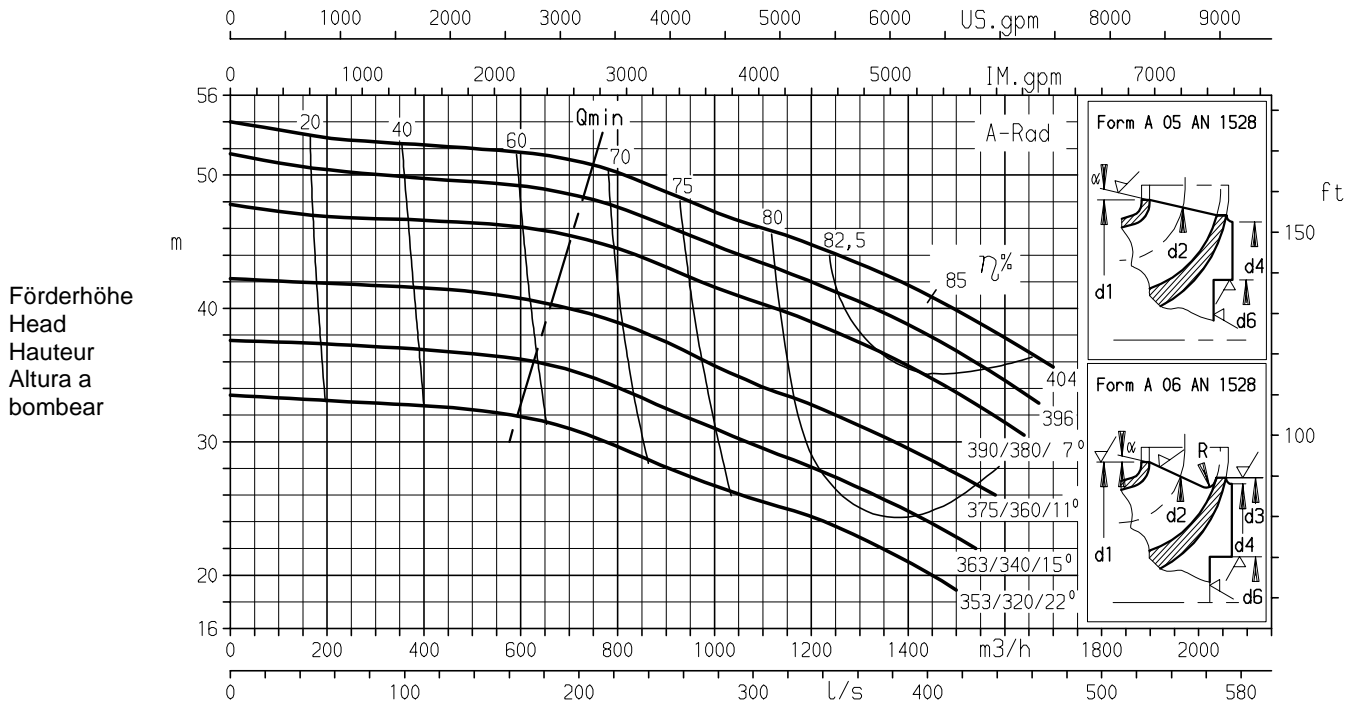



Laufradaustrittsbreite/Impeller outlet width 68 mm
 Largeur à la sortie de la roue/Anchura de salida del rodete 68 mm

Förderstrom/Capacity/Débit/Caudal

K 2721.454/606/6

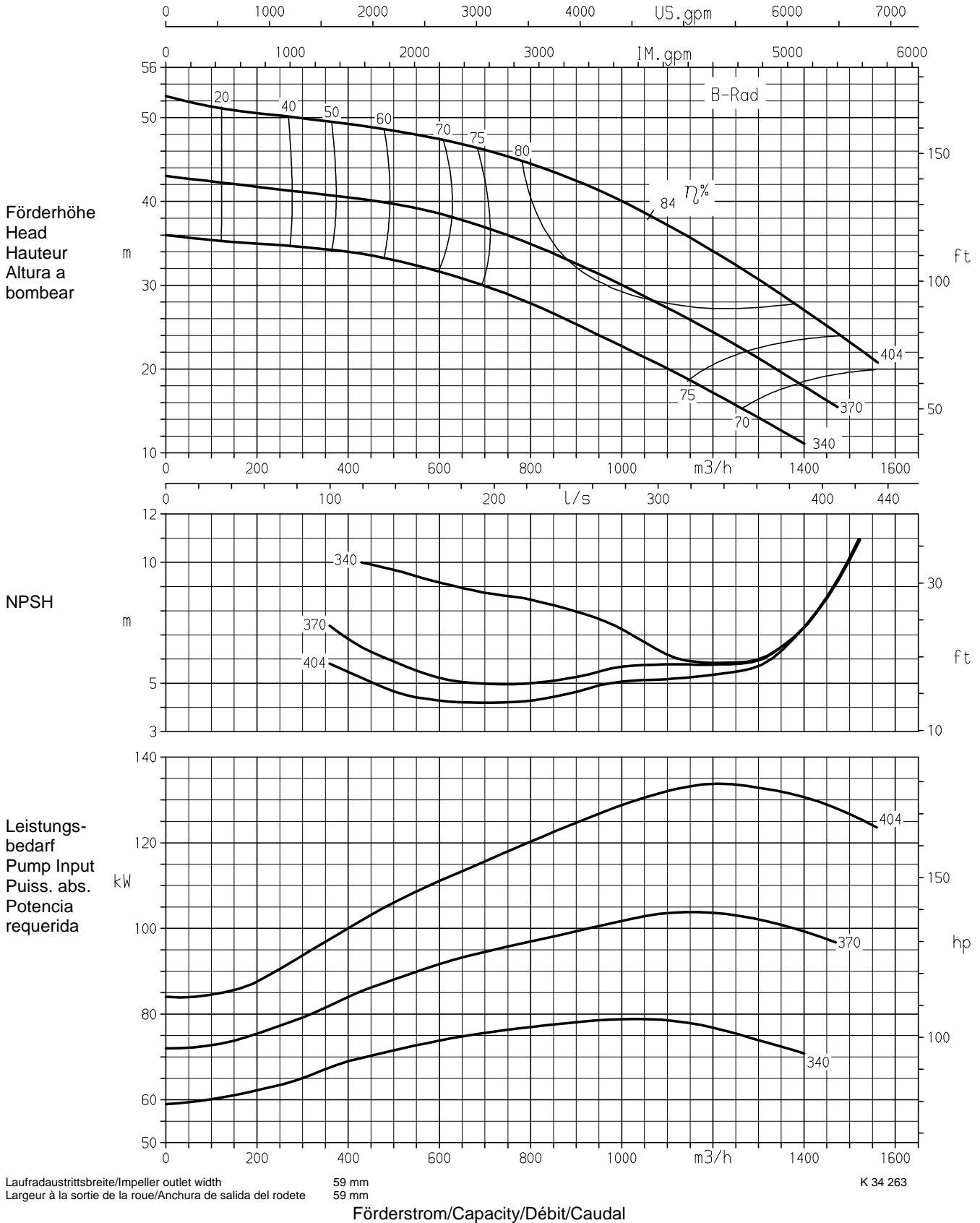
Baureihe Pump type CPK/HPK B-Rad	Modèle Tipo 300-400	Nenndrehzahl Nom. speed 1450 1/min	Vitesse nom. Revoluciones nom.	 KSB Aktiengesellschaft Pumpen Industrie- und Wassertechnik Postfach 13 60, D-91253 Pegnitz Bahnhofplatz 1, D-91257
Angebots-Nr. Project No.	No. de l'offre Oferta-No.	Pos.-Nr. Item No.	No. de pos. No. de pos.	



Baureihe Pump type	Modèle Tipo	Nennzahl Nom. speed	Vitesse nom. Revoluciones nom.	 KSB KSB Aktiengesellschaft Pumpen Industrie- und Wassertechnik Postfach 13 60, D-91253 Pegnitz Bahnhofplatz 1, D-91257
CPK/HPK	300-500	1450 1/min		
Angebots-Nr. Project No.	No. de l'offre Oferta-No.	Pos.-Nr. Item No.	No. de pos. No. de pos.	

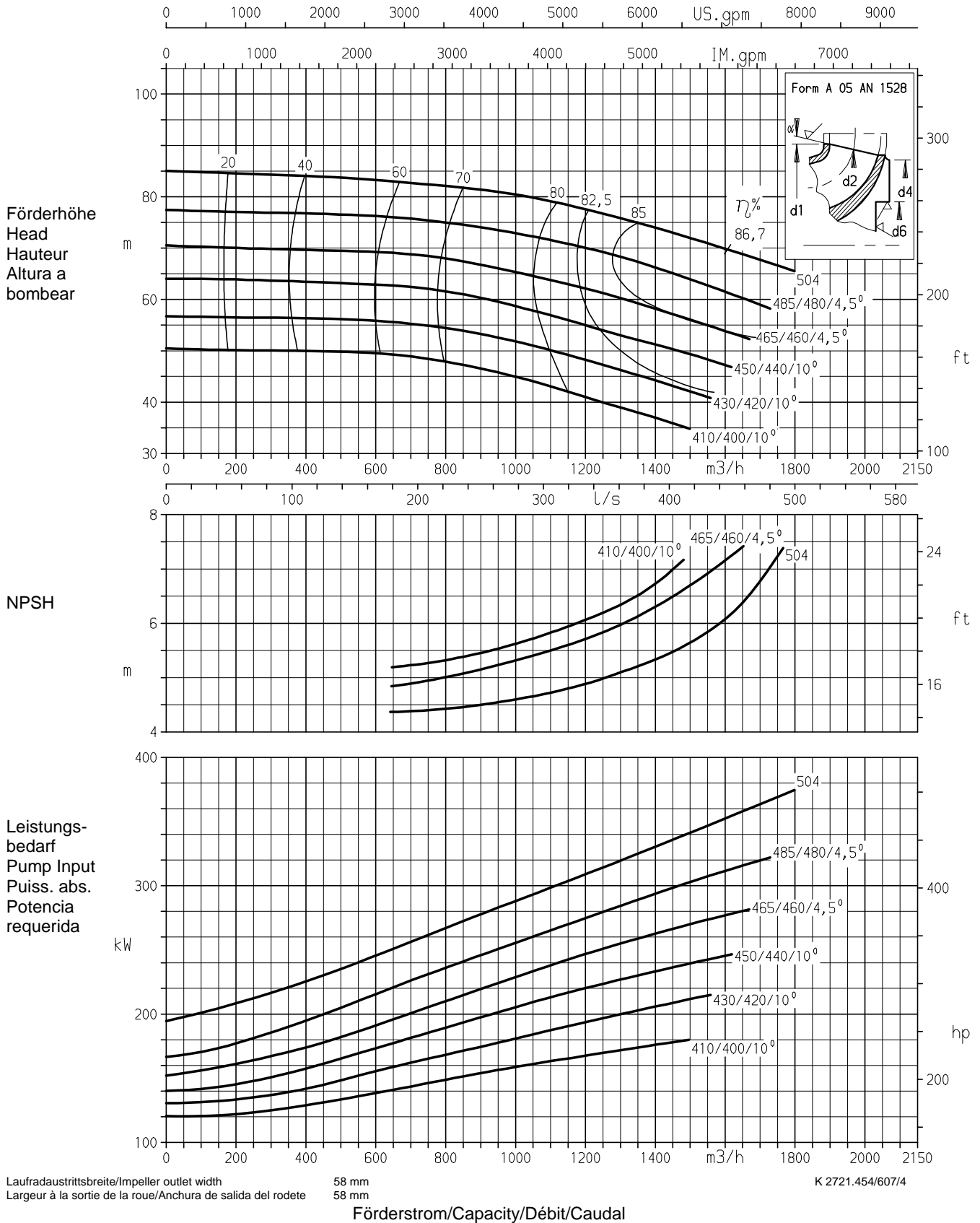

Baureihe Pump type CPK/HPK A-Rad	Modèle Tipo 350-400	Nennrehzahl Nom. speed 1450 1/min	Vitesse nom. Revoluciones nom.	 KSB KSB Aktiengesellschaft Pumpen Industrie- und Wassertechnik Postfach 13 60, D-91253 Pegnitz Bahnhofplatz 1, D-91257
Angebots-Nr. Project No.	No. de l'offre Oferta-No.	Pos.-Nr. Item No.	No. de pos. No. de pos.	

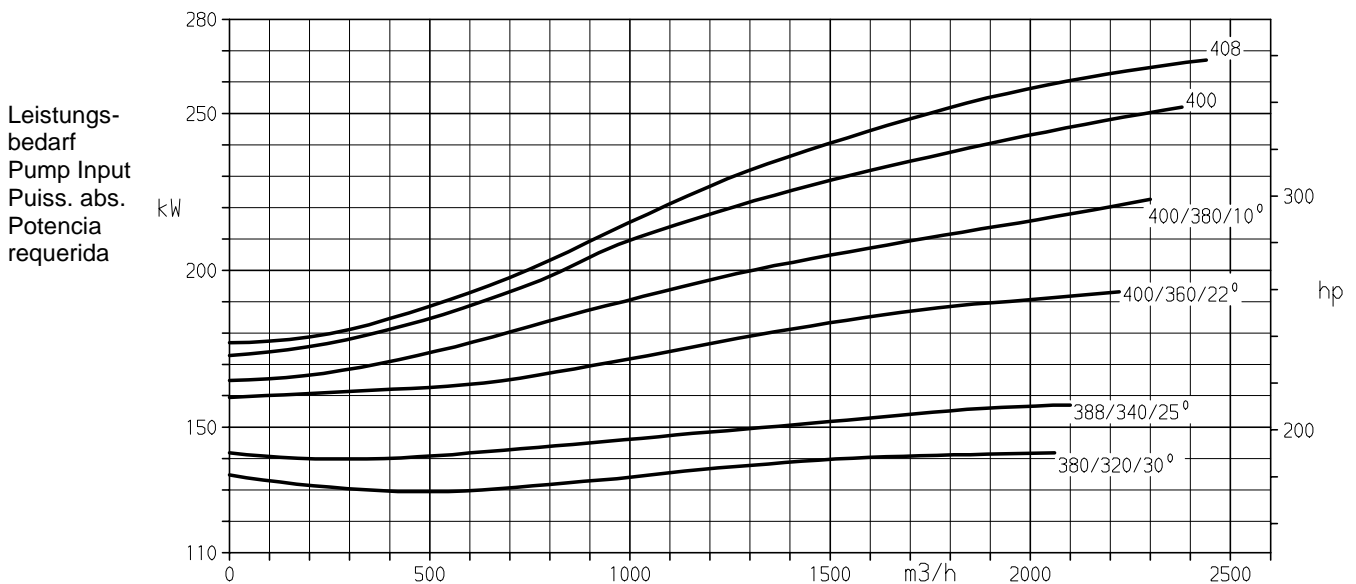
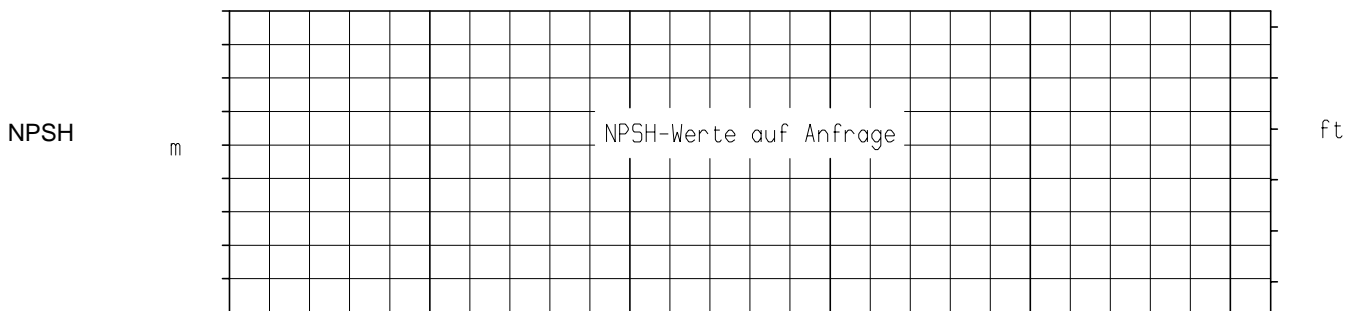
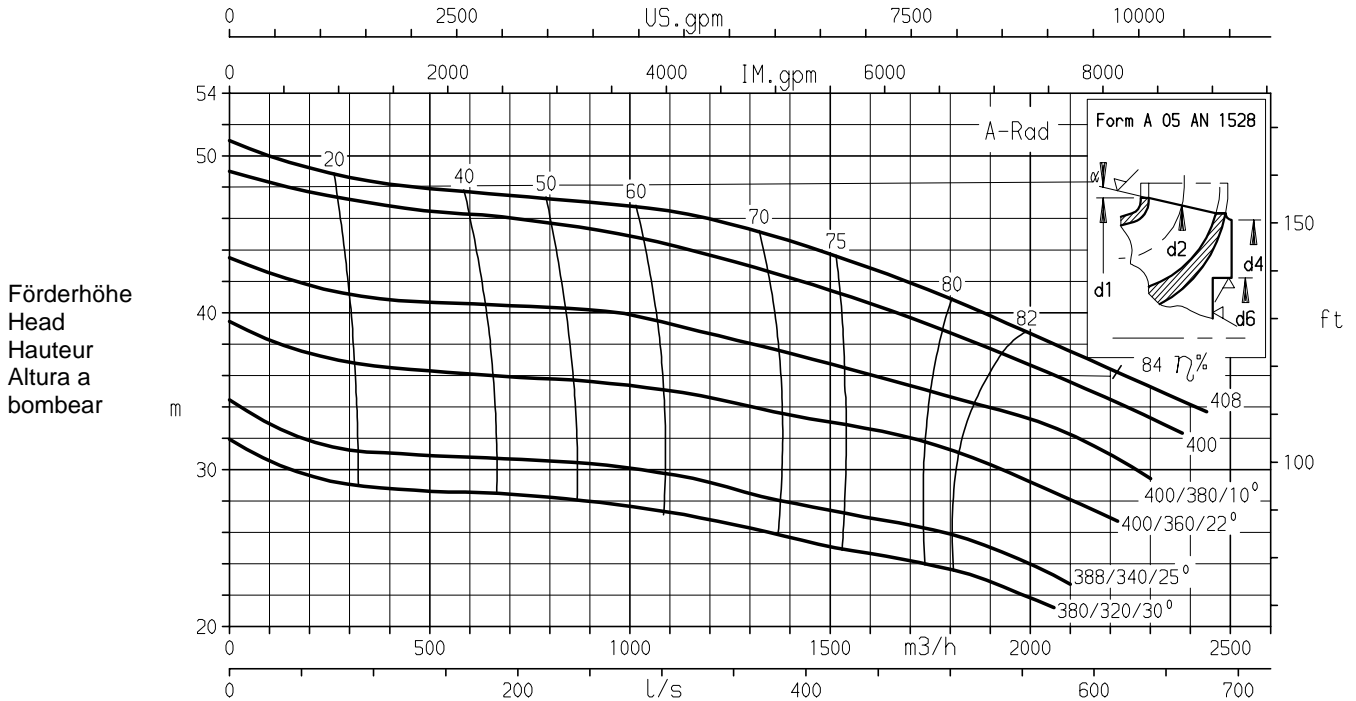

Laufradaustrittsbreite/Impeller outlet width
Largeur à la sortie de la roue/Anchura de salida del rodete

115 mm
115 mm

K 2721.454/625/2

Förderstrom/Capacity/Débit/Caudal

Baureihe Pump type CPK/HPK B-Rad	Modèle Tipo 350-400	Nennrehzahl Nom. speed 1450 1/min	Vitesse nom. Revoluciones nom.	 KSB KSB Aktiengesellschaft Pumpen Industrie- und Wassertechnik Postfach 13 60, D-91253 Pegnitz Bahnhofplatz 1, D-91257
Angebots-Nr. Project No.	No. de l'offre Oferta-No.	Pos.-Nr. Item No.	No. de pos. No. de pos.	

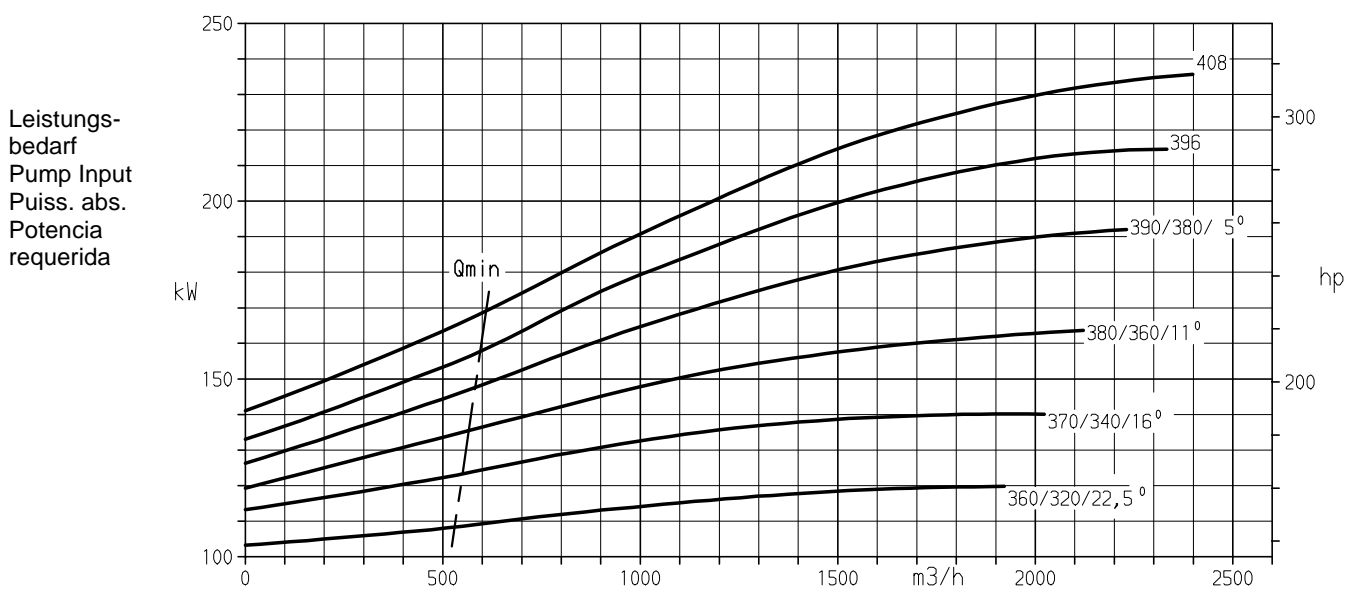
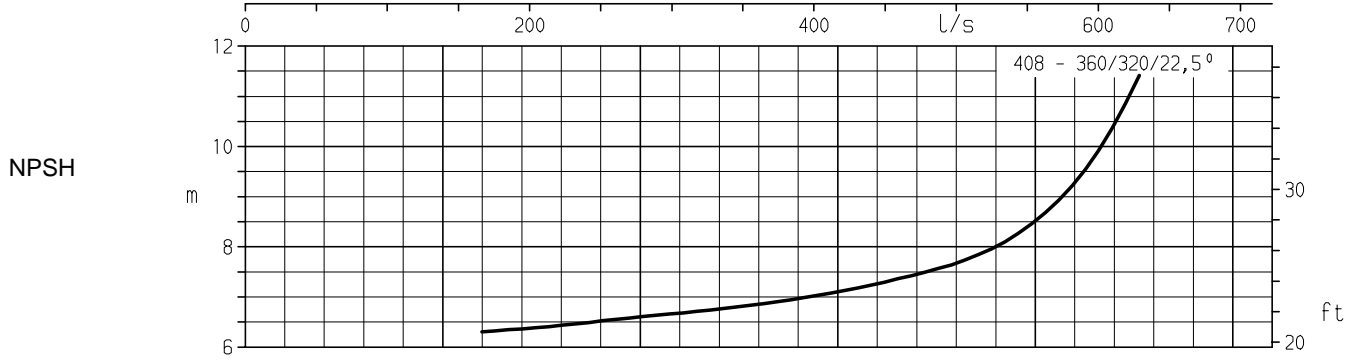
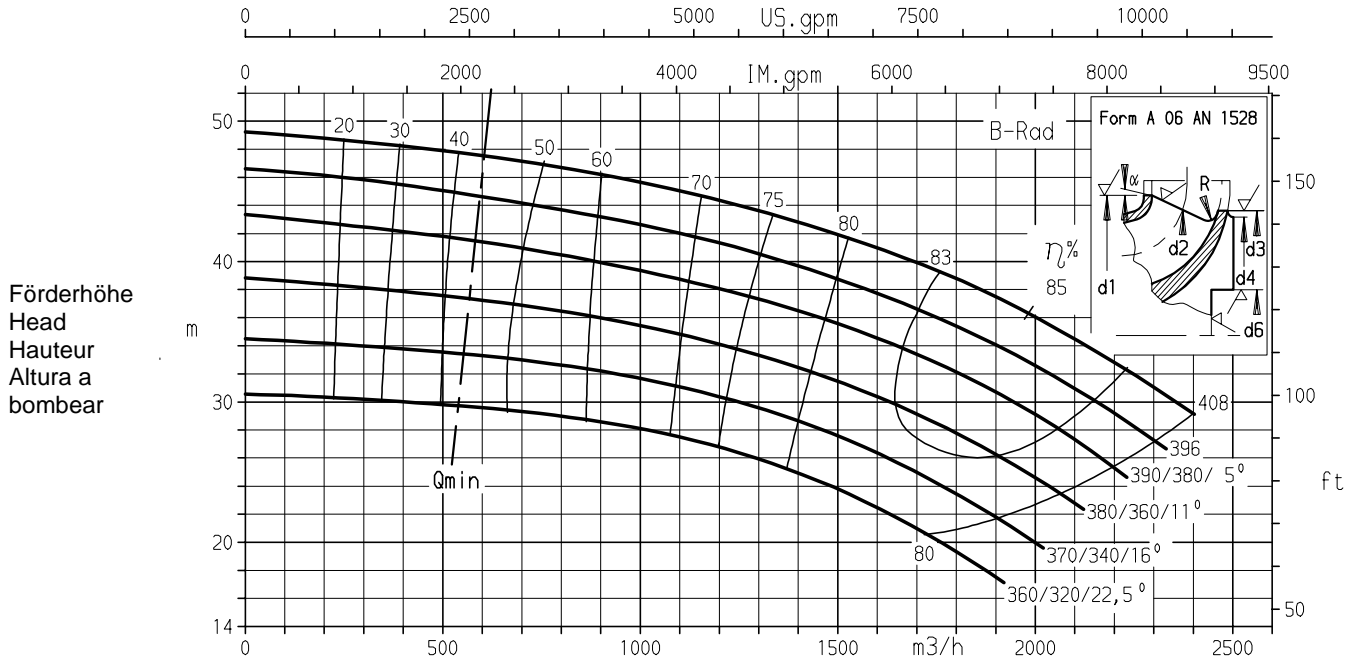

Laufradaustrittsbreite/Impeller outlet width 99 mm
 Largeur à la sortie de la roue/Anchura de salida del rodete 99 mm
 Förderstrom/Capacity/Débit/Caudal K 34 267

Baureihe Pump type	Modèle Tipo	Nenndrehzahl Nom. speed	Vitesse nom. Revoluciones nom.	 KSB KSB Aktiengesellschaft Pumpen Industrie- und Wassertechnik Postfach 13 60, D-91253 Pegnitz Bahnhofplatz 1, D-91257
CPK/HPK	350-500	1450 1/min		
Angebots-Nr. Project No.	No. de l'offre Oferta-No.	Pos.-Nr. Item No.	No. de pos. No. de pos.	

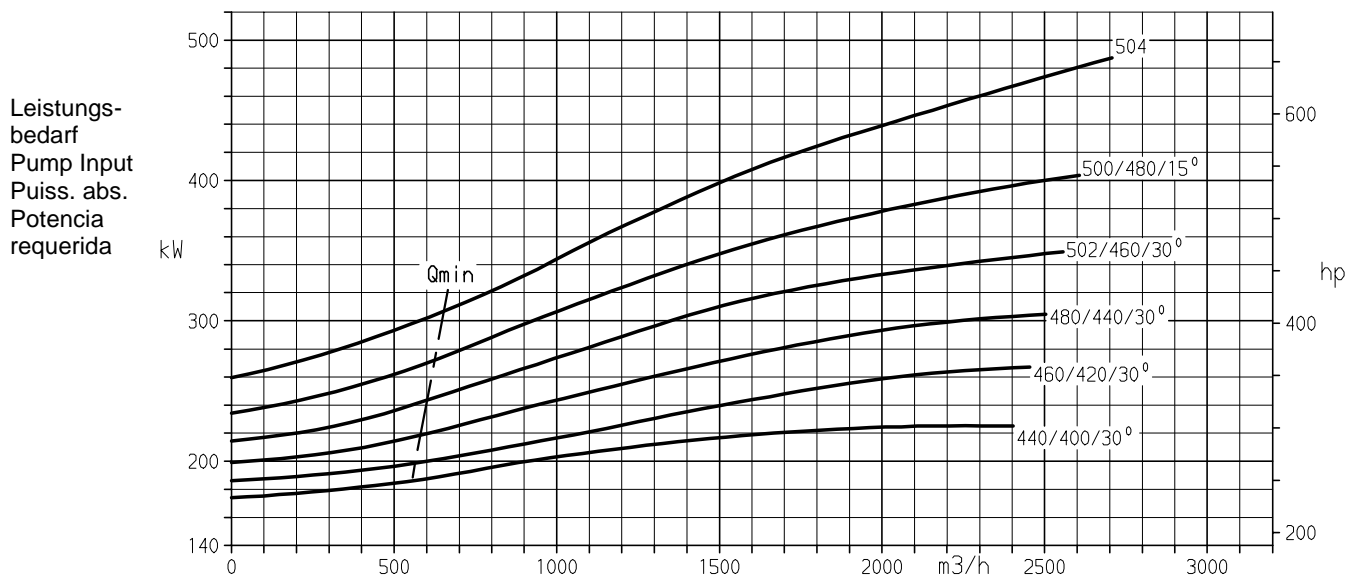
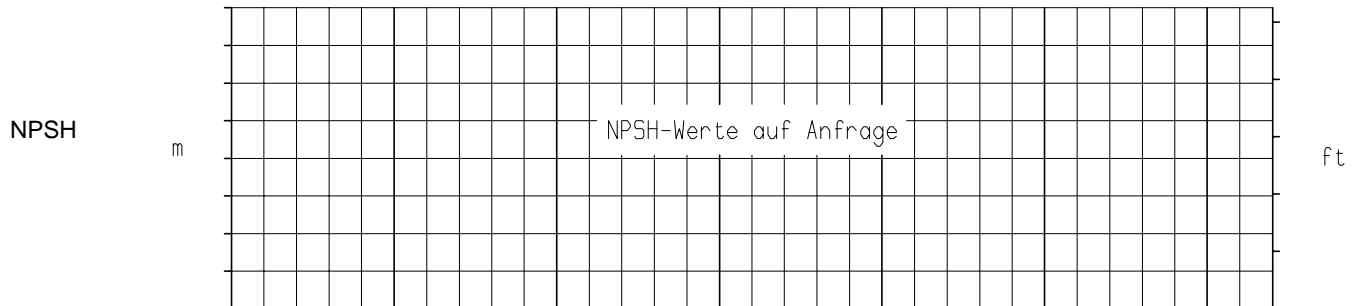
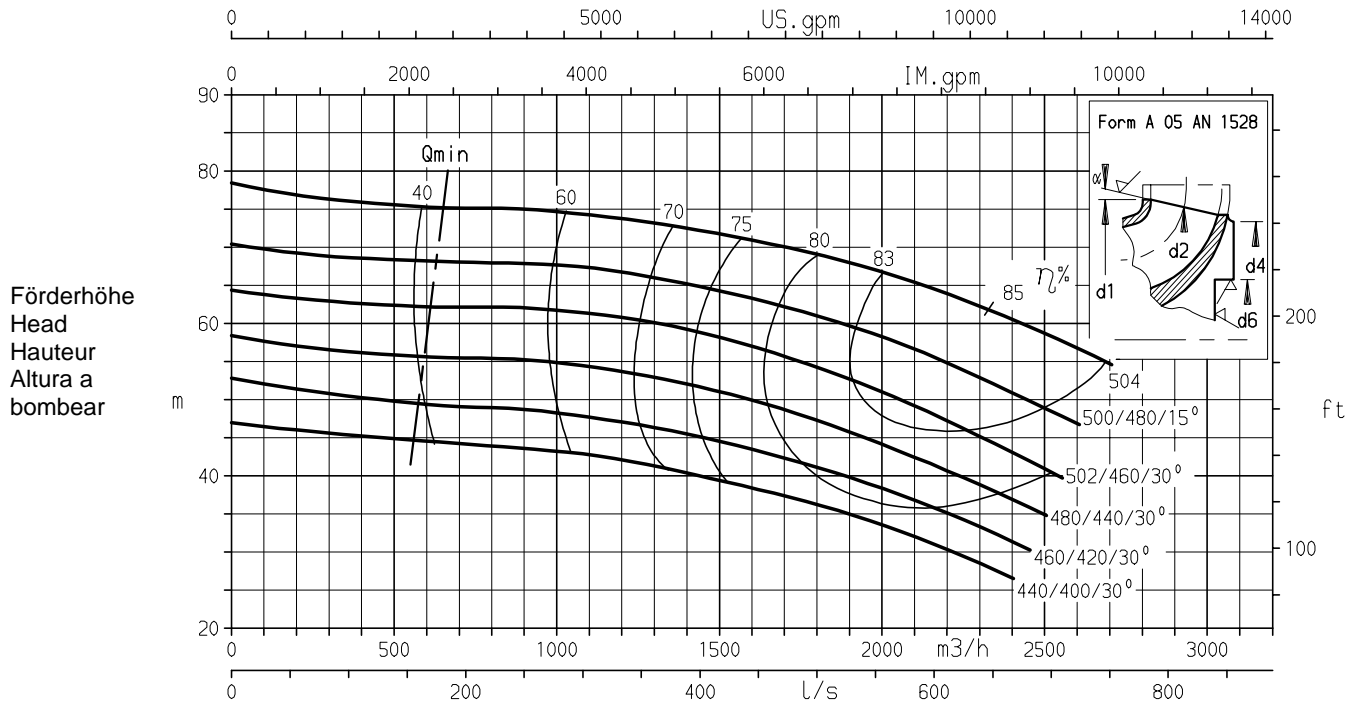

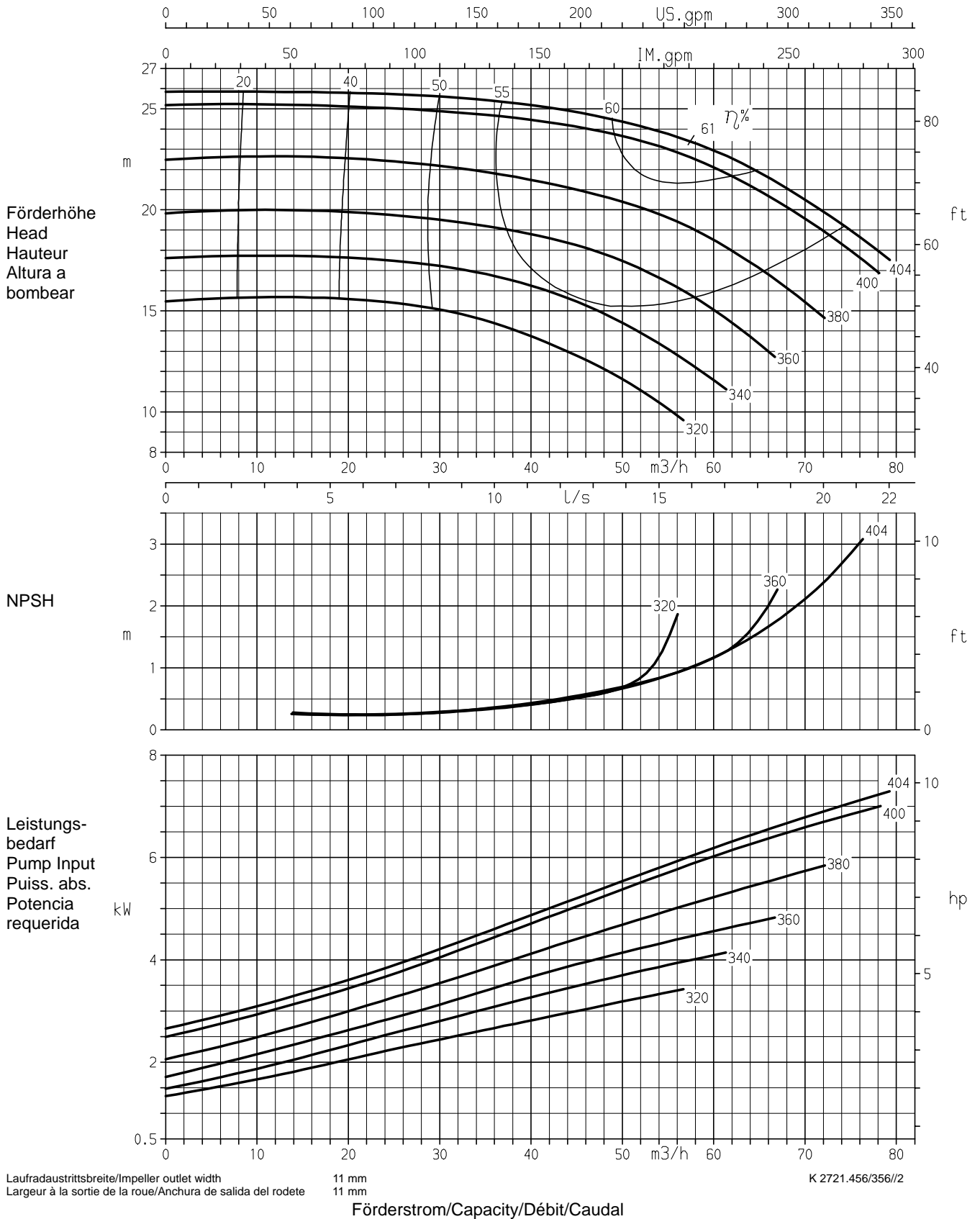

Laufraudausrittsbreite/Impeller outlet width 72 mm 72 mm K 2721.454/608/3
Largeur à la sortie de la roue/Anchura de salida del rodete 72 mm

Baureihe Pump type	Modèle Tipo	Nenn Drehzahl Nom. speed	Vitesse nom. Revoluciones nom.	 KSB KSB Aktiengesellschaft Pumpen Industrie- und Wassertechnik Postfach 13 60, D-91253 Pegnitz Bahnhofplatz 1, D-91257
CPK/HPK	80-400	960 1/min		
Angebots-Nr. Project No.	No. de l'offre Oferta-No.	Pos.-Nr. Item No.	No. de pos. No. de pos.	

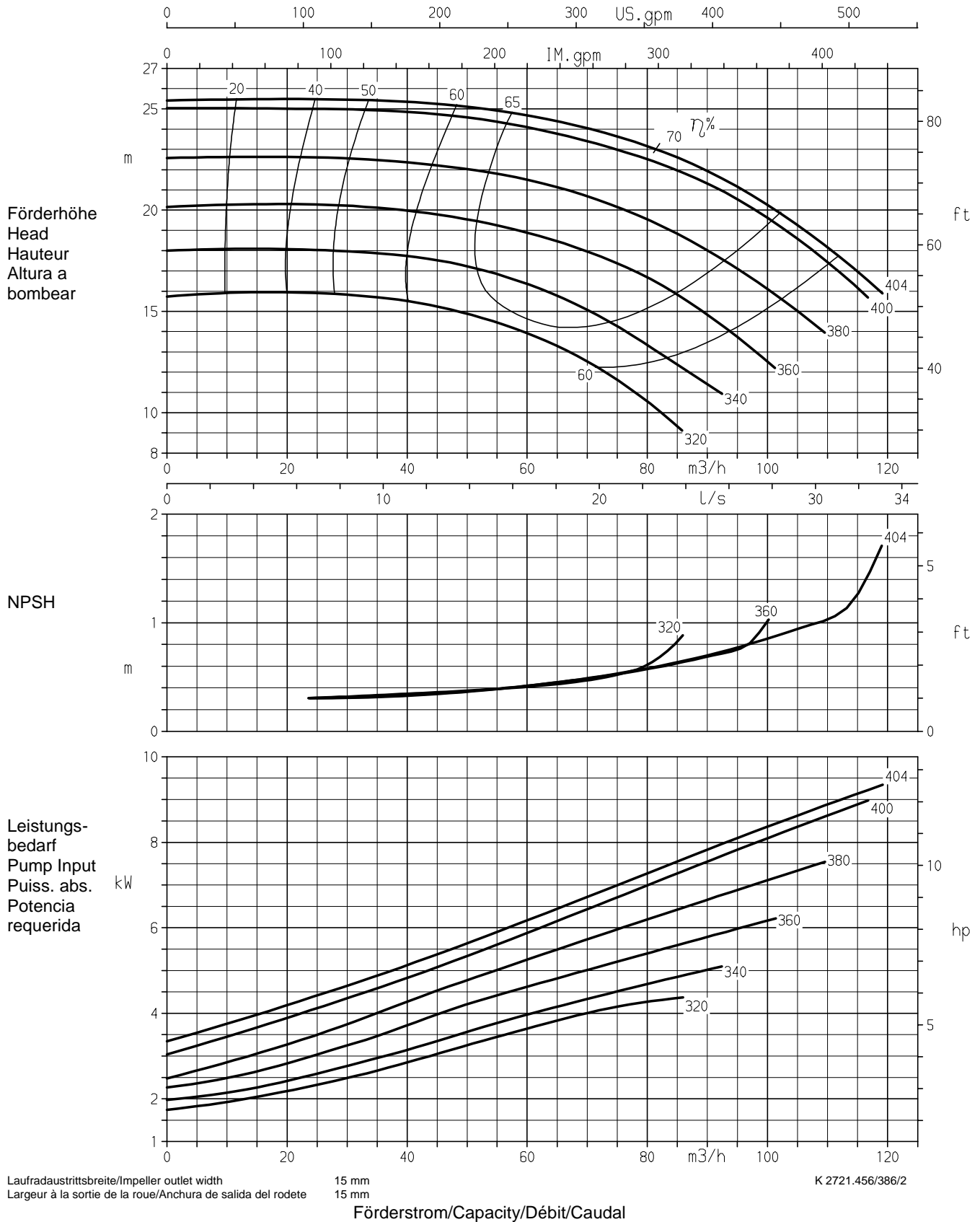

Baureihe Pump type	Modèle Tipo	Nenn Drehzahl Nom. speed	Vitesse nom. Revoluciones nom.	 KSB KSB Aktiengesellschaft Pumpen Industrie- und Wassertechnik Postfach 13 60, D-91253 Pegnitz Bahnhofplatz 1, D-91257
CPK/HPK	100-400	960 1/min		
Angebots-Nr. Project No.	No. de l'offre Oferta-No.	Pos.-Nr. Item No.	No. de pos. No. de pos.	



Baureihe Pump type	Modèle Tipo	Nenn Drehzahl Nom. speed	Vitesse nom. Revoluciones nom.	 KSB KSB Aktiengesellschaft Pumpen Industrie- und Wassertechnik Postfach 13 60, D-91253 Pegnitz Bahnhofplatz 1, D-91257
CPK/HPK	125-400	960 1/min		
Angebots-Nr. Project No.	No. de l'offre Oferta-No.	Pos.-Nr. Item No.	No. de pos. No. de pos.	

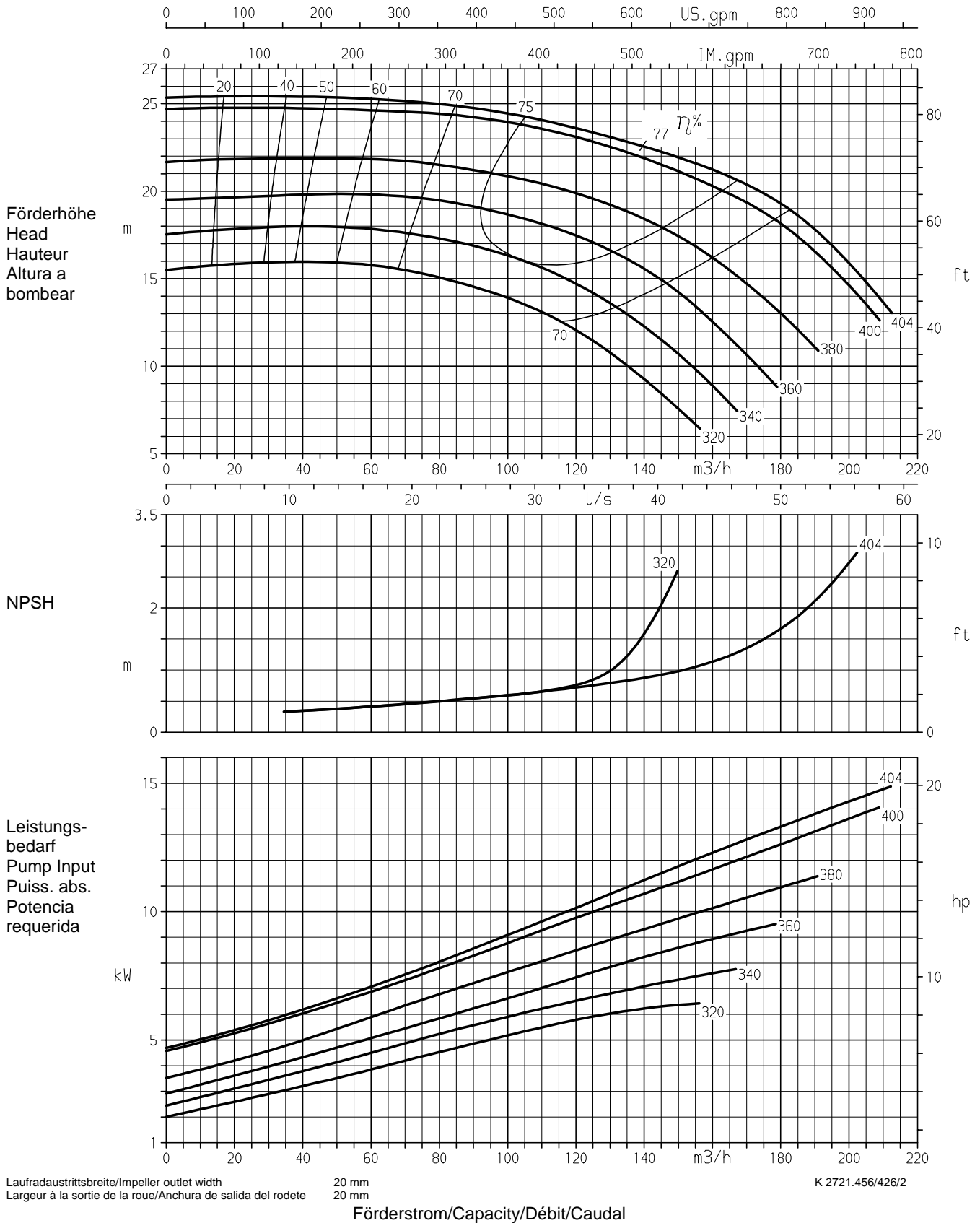

Baureihe Pump type	Modèle Tipo	Nenn Drehzahl Nom. speed	Vitesse nom. Revoluciones nom.	 KSB KSB Aktiengesellschaft Pumpen Industrie- und Wassertechnik Postfach 13 60, D-91253 Pegnitz Bahnhofplatz 1, D-91257
CPK/HPK	150-250	960 1/min		
Angebots-Nr. Project No.	No. de l'offre Oferta-No.	Pos.-Nr. Item No.	No. de pos. No. de pos.	

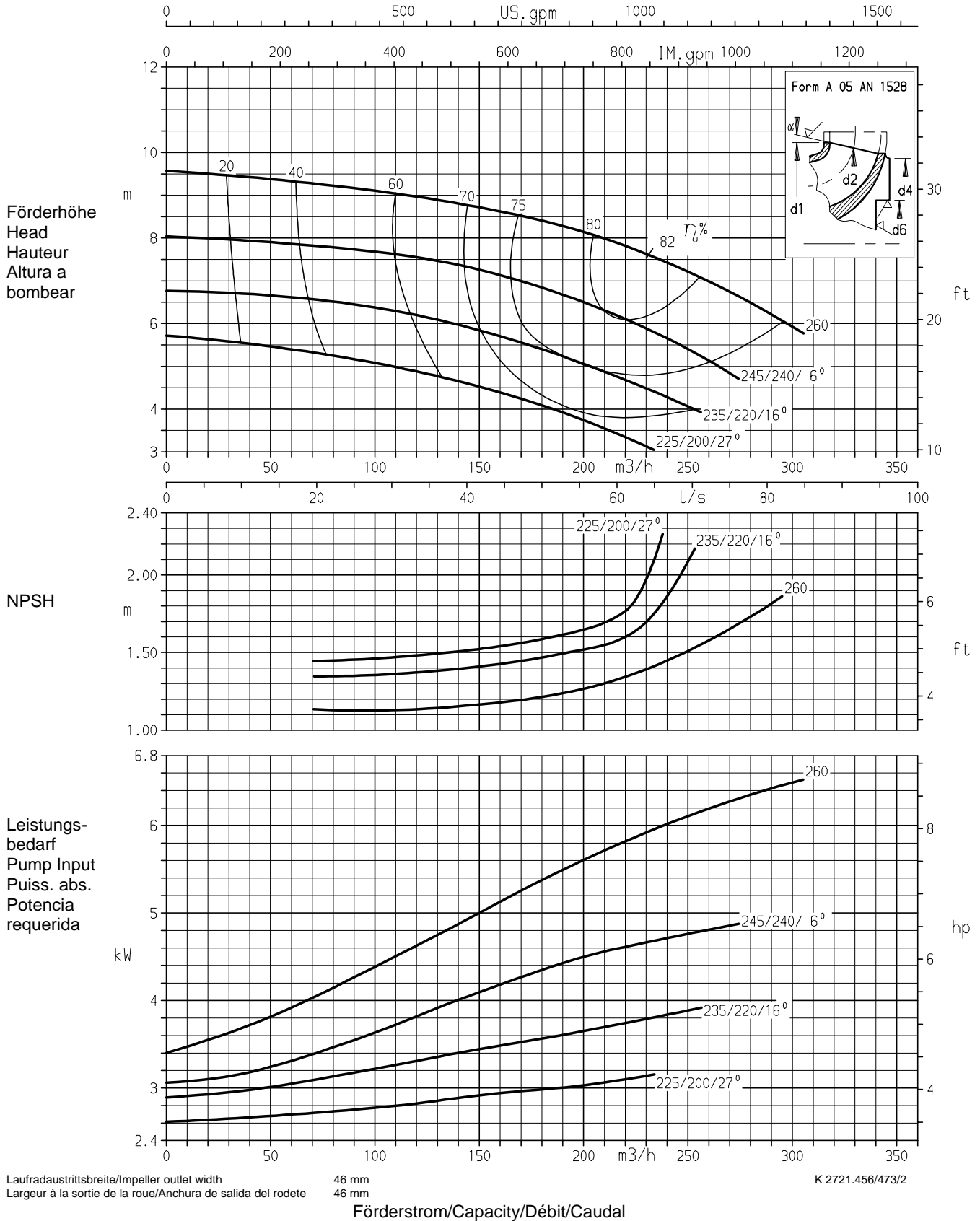

Baureihe Pump type	Modèle Tipo	Nennrehzahl Nom. speed	Vitesse nom. Revoluciones nom.	 KSB KSB Aktiengesellschaft Pumpen Industrie- und Wassertechnik Postfach 13 60, D-91253 Pegnitz Bahnhofplatz 1, D-91257
CPK/HPK	150-315	960 1/min		
Angebots-Nr. Project No.	No. de l'offre Oferta-No.	Pos.-Nr. Item No.	No. de pos. No. de pos.	

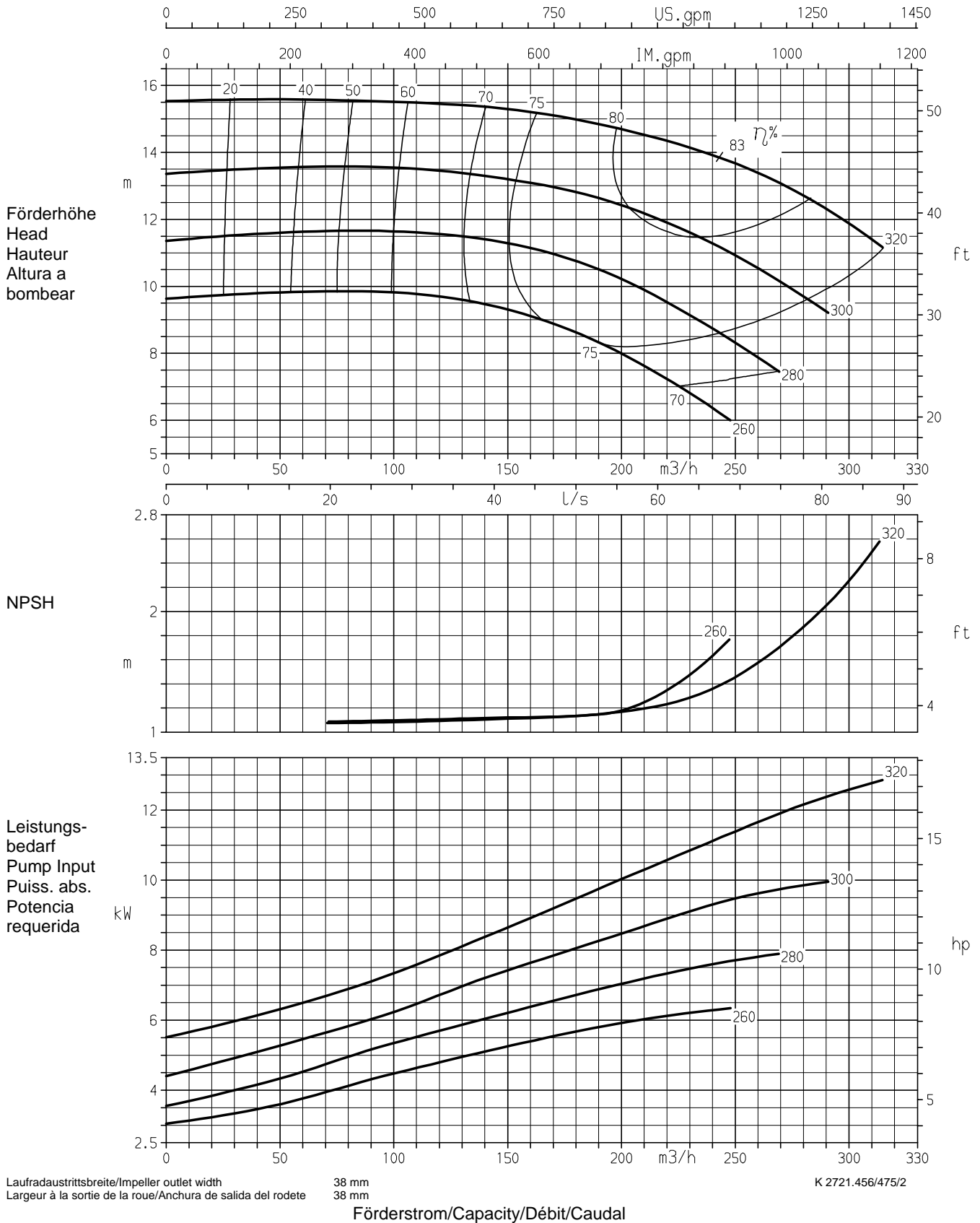

Baureihe Pump type	Modèle Tipo	Nenn Drehzahl Nom. speed	Vitesse nom. Revoluciones nom.	 KSB KSB Aktiengesellschaft Pumpen Industrie- und Wassertechnik Postfach 13 60, D-91253 Pegnitz Bahnhofplatz 1, D-91257
CPK/HPK	150-400	960 1/min		
Angebots-Nr. Project No.	No. de l'offre Oferta-No.	Pos.-Nr. Item No.	No. de pos. No. de pos.	

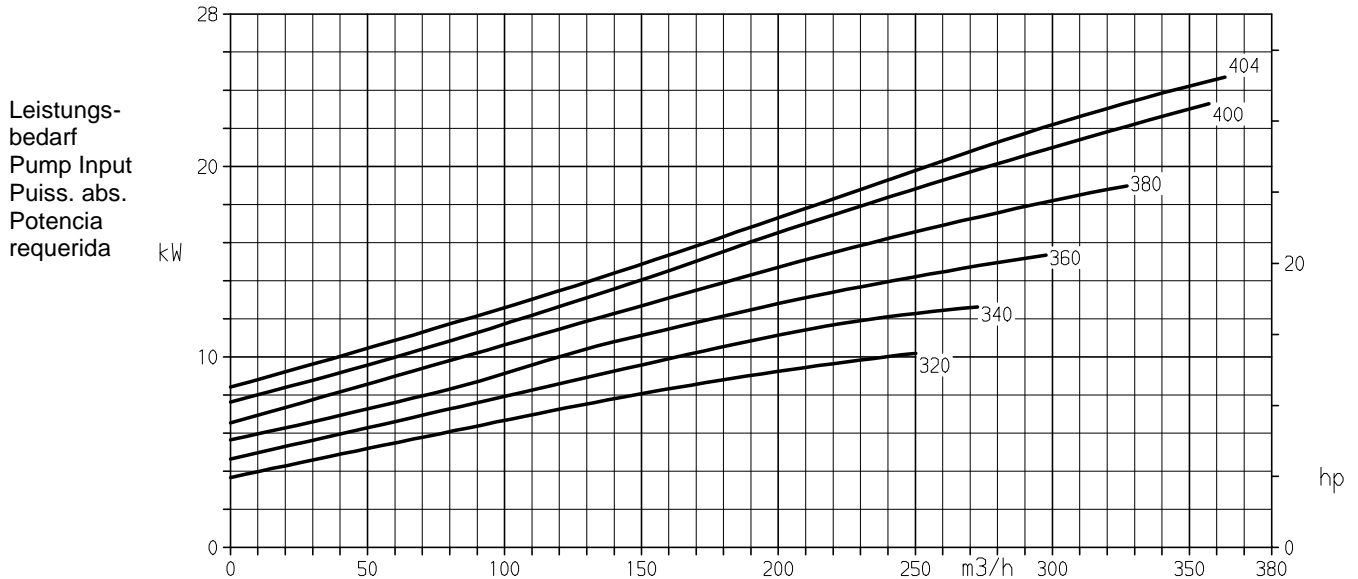
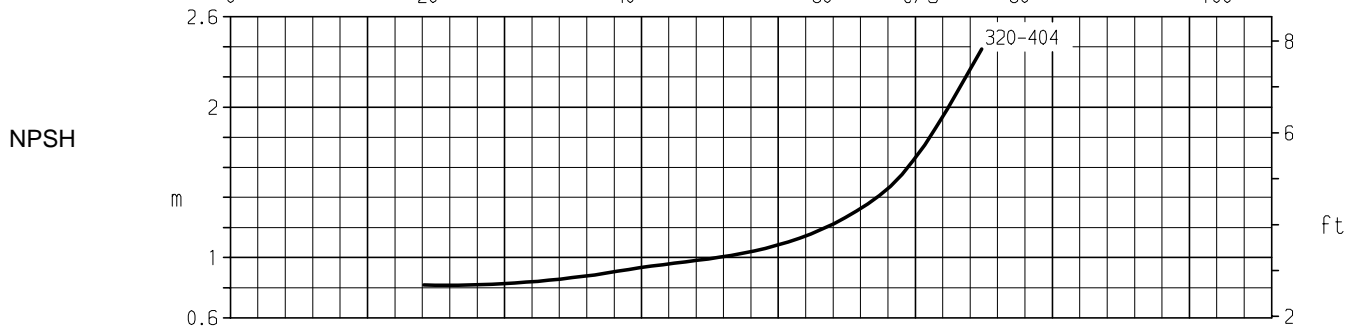
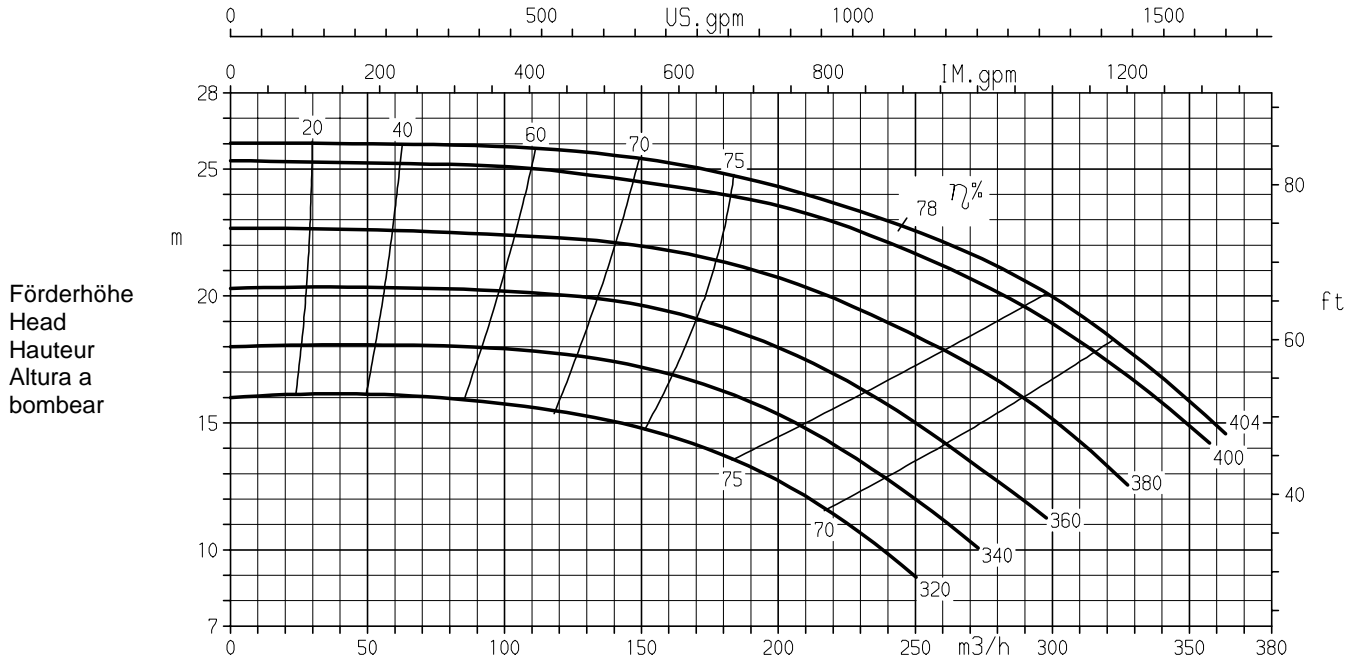

Laufraudaustrittsweite/Impeller outlet width
Largeur à la sortie de la roue/Anchura de salida del rodete

29 mm
29 mm

K 2721.456/476/2

Förderstrom/Capacity/Débit/Caudal

Baureihe Pump type	Modèle Tipo	Nenn Drehzahl Nom. speed	Vitesse nom. Revoluciones nom.	 KSB KSB Aktiengesellschaft Pumpen Industrie- und Wassertechnik Postfach 13 60, D-91253 Pegnitz Bahnhofplatz 1, D-91257
CPK/HPK	150-500	960 1/min		
Angebots-Nr. Project No.	No. de l'offre Oferta-No.	Pos.-Nr. Item No.	No. de pos. No. de pos.	

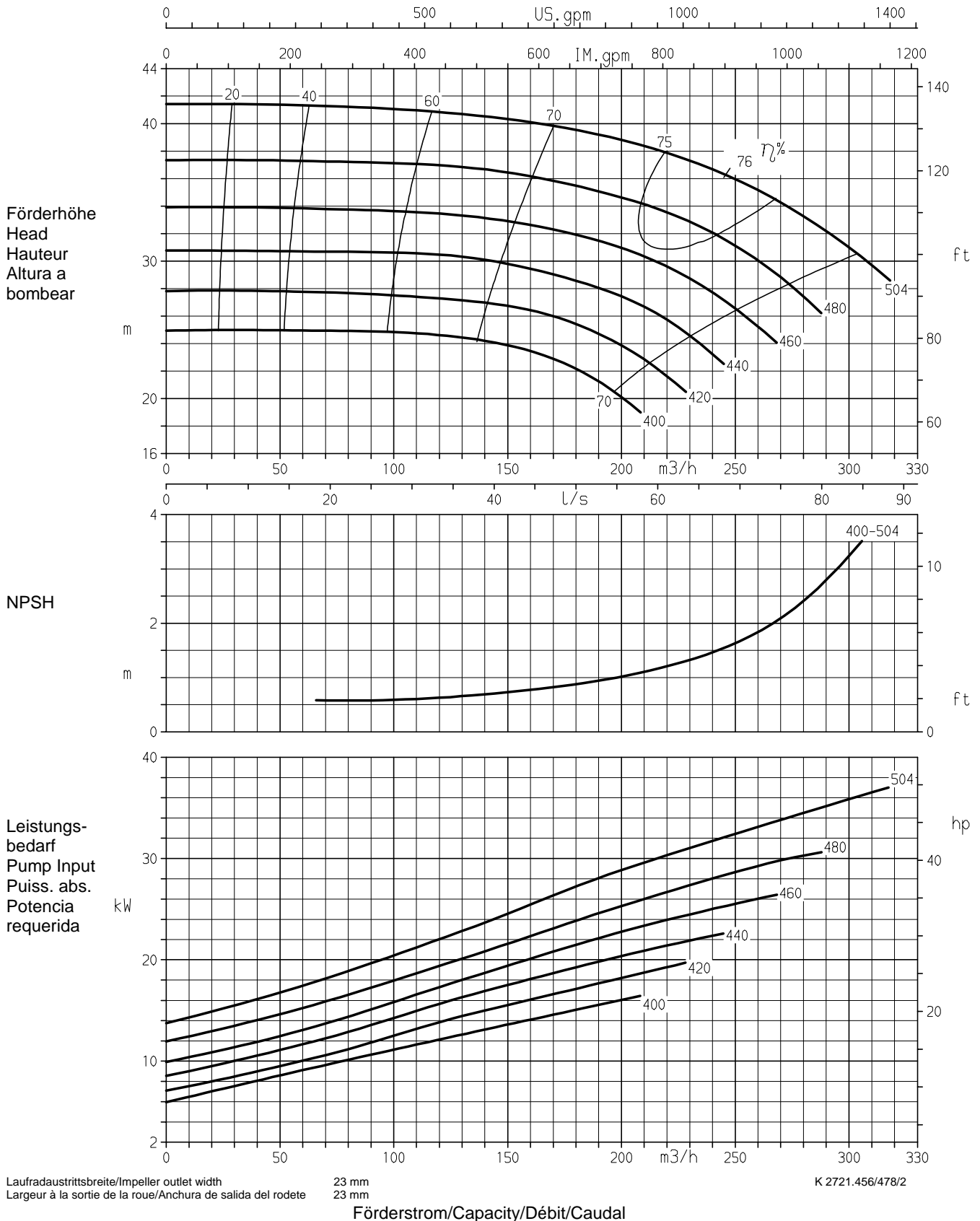

Baureihe Pump type	Modèle Tipo	Nenn Drehzahl Nom. speed	Vitesse nom. Revoluciones nom.	 KSB KSB Aktiengesellschaft Pumpen Industrie- und Wassertechnik Postfach 13 60, D-91253 Pegnitz Bahnhofplatz 1, D-91257
CPK/HPK	200-250	960 1/min		
Angebots-Nr. Project No.	No. de l'offre Oferta-No.	Pos.-Nr. Item No.	No. de pos. No. de pos.	

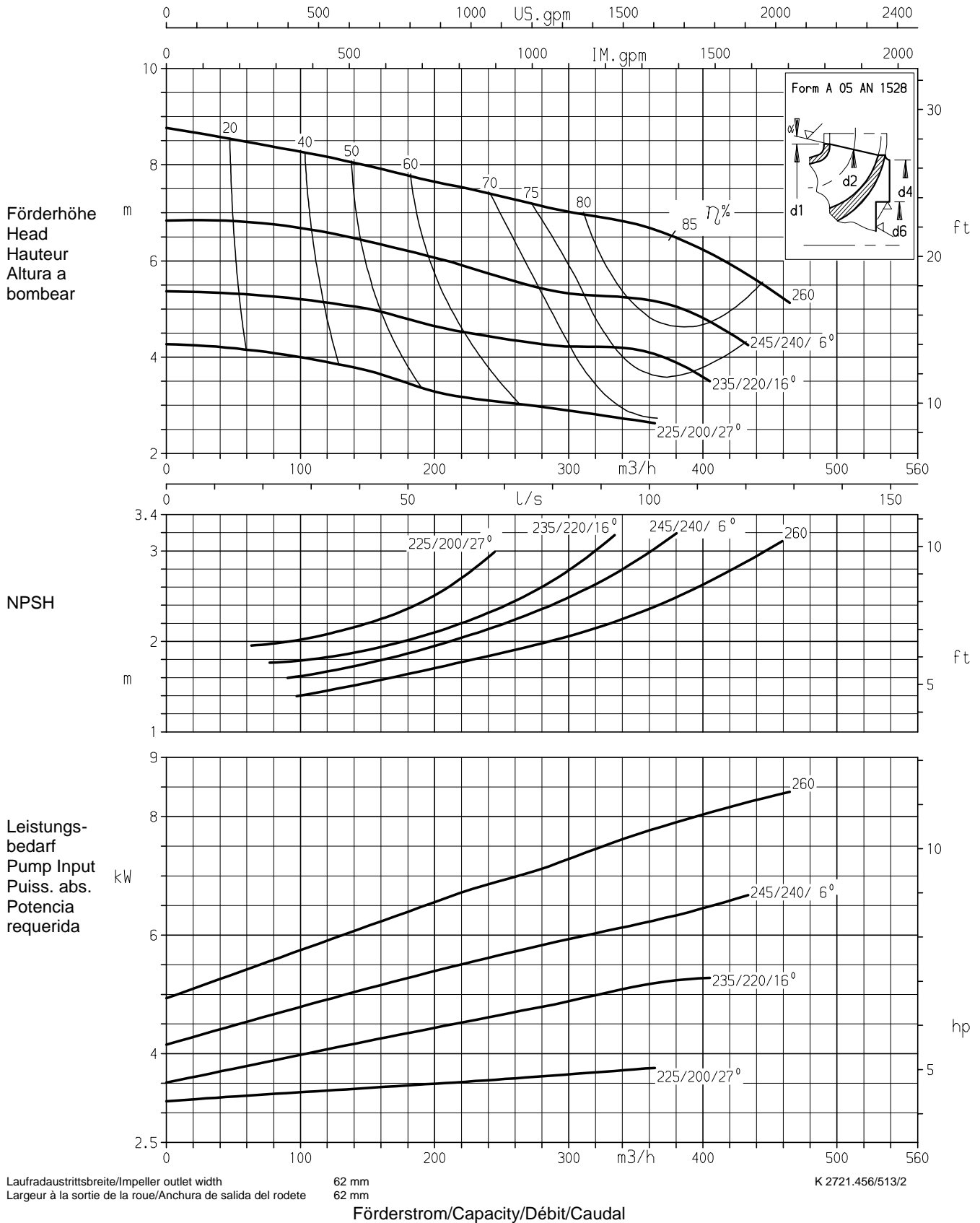

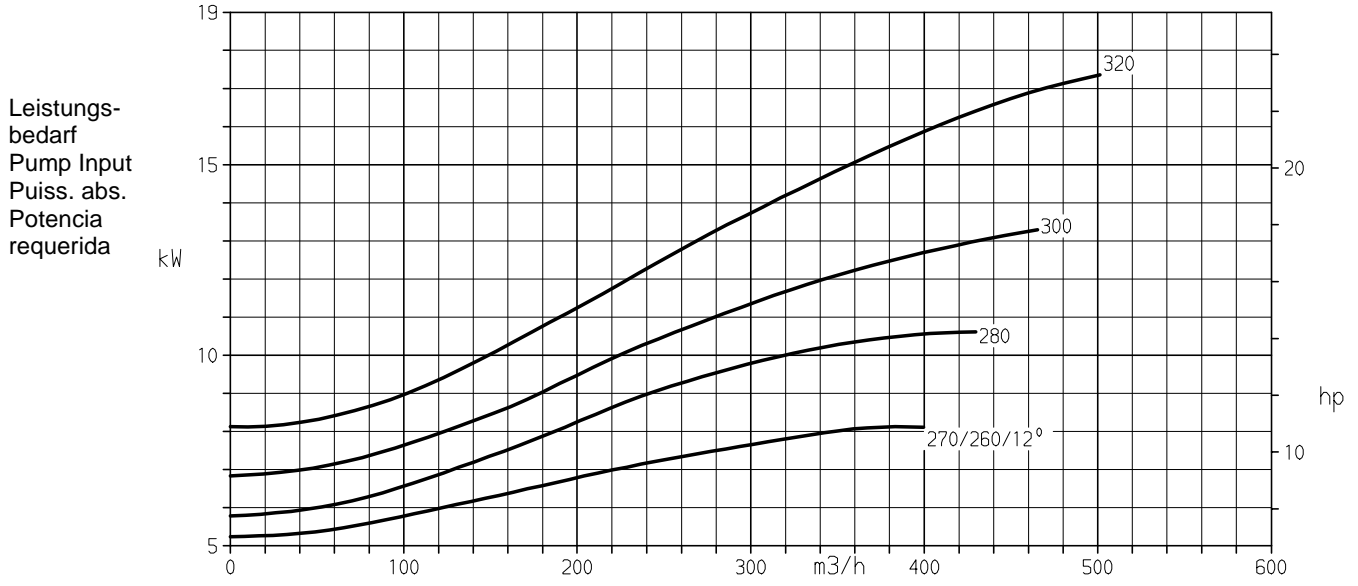
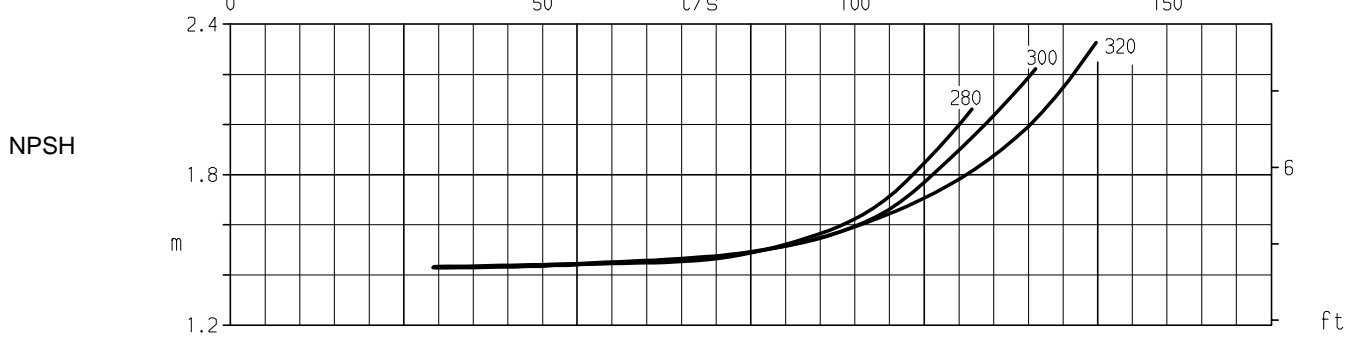
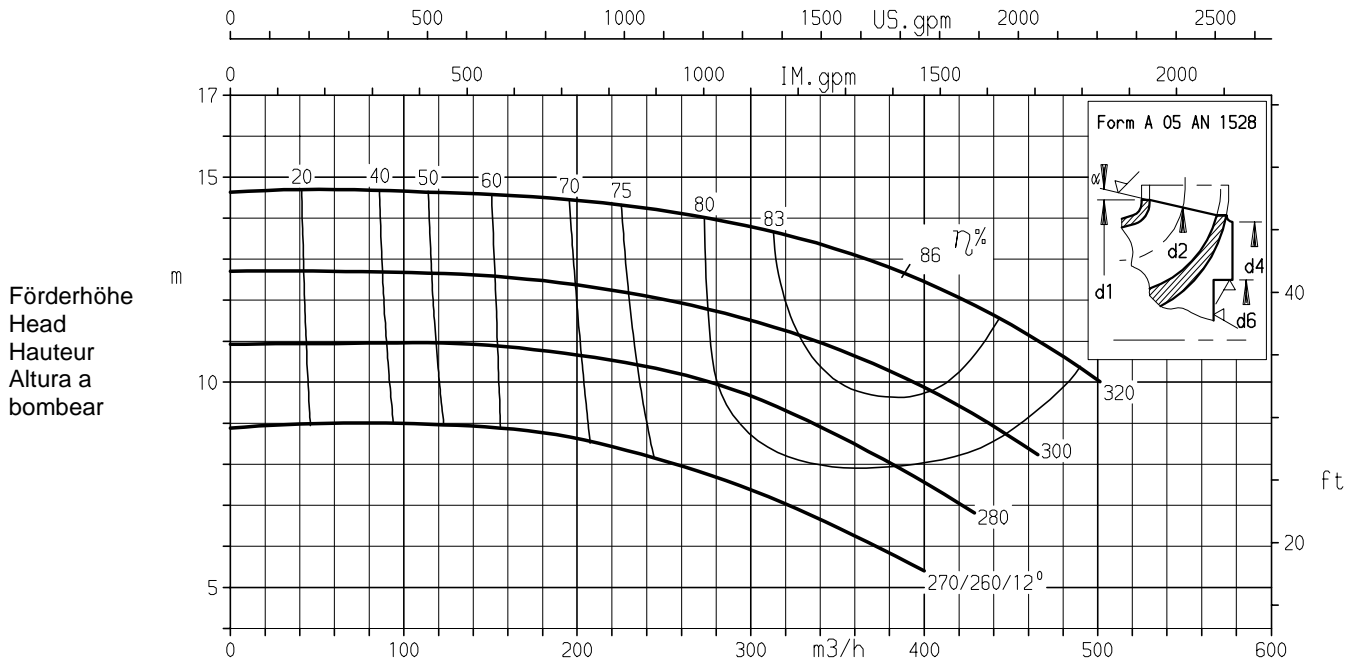

Baureihe Pump type	Modèle Tipo	Nennzahl Nom. speed	Vitesse nom. Revoluciones nom.	 KSB KSB Aktiengesellschaft Pumpen Industrie- und Wassertechnik Postfach 13 60, D-91253 Pegnitz Bahnhofplatz 1, D-91257
CPK/HPK	200-315	960 1/min		
Angebots-Nr. Project No.	No. de l'offre Oferta-No.	Pos.-Nr. Item No.	No. de pos. No. de pos.	



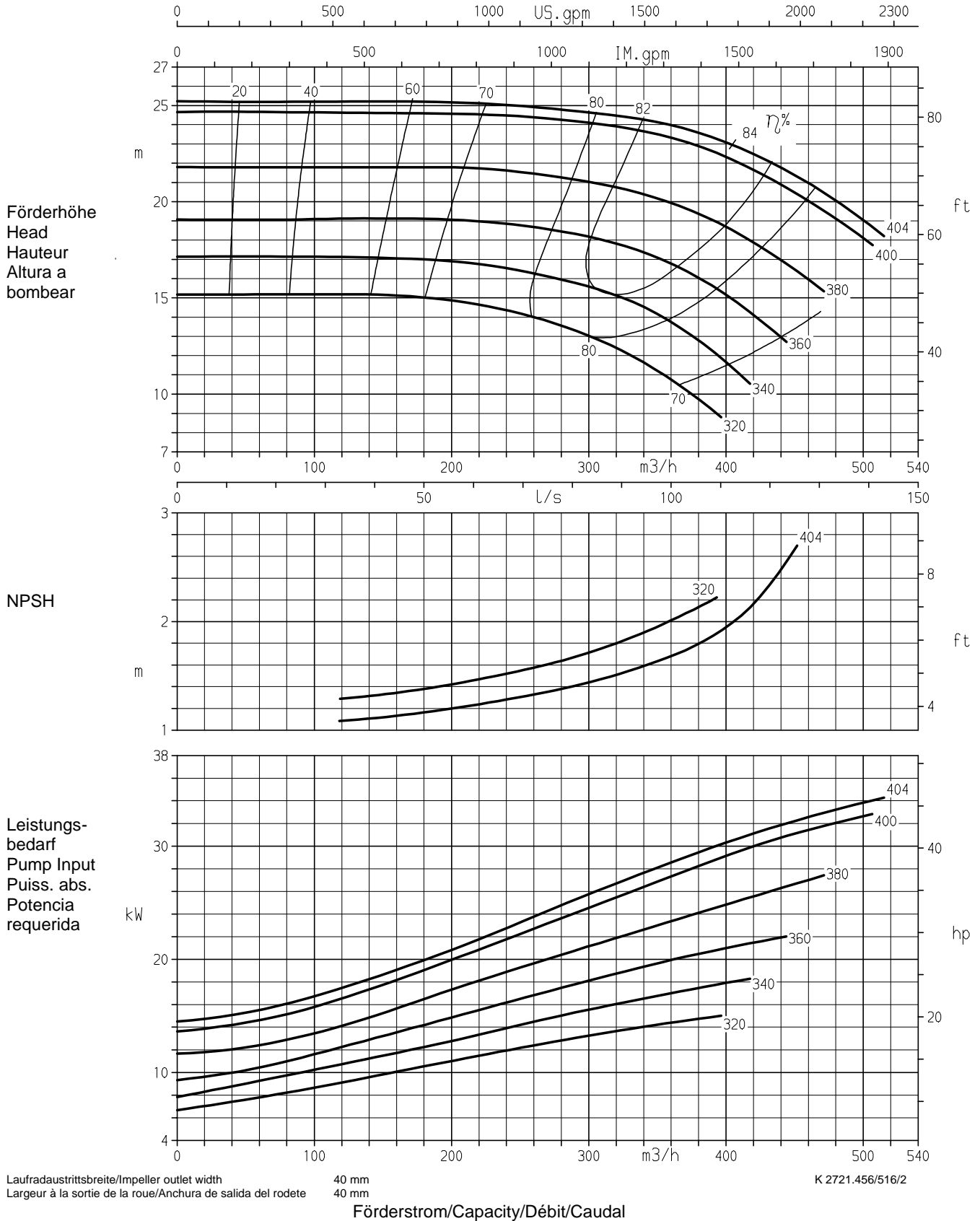

Laufradaustrittsbreite/Impeller outlet width 50 mm
 Largeur à la sortie de la roue/Anchura de salida del rodete 50 mm
 Förderstrom/Capacity/Débit/Caudal K 2721.456/515/2

Baureihe Pump type	Modèle Tipo	Nenn Drehzahl Nom. speed	Vitesse nom. Revoluciones nom.	 KSB KSB Aktiengesellschaft Pumpen Industrie- und Wassertechnik Postfach 13 60, D-91253 Pegnitz Bahnhofplatz 1, D-91257
CPK/HPK	200-400	960 1/min		
Angebots-Nr. Project No.	No. de l'offre Oferta-No.	Pos.-Nr. Item No.	No. de pos. No. de pos.	

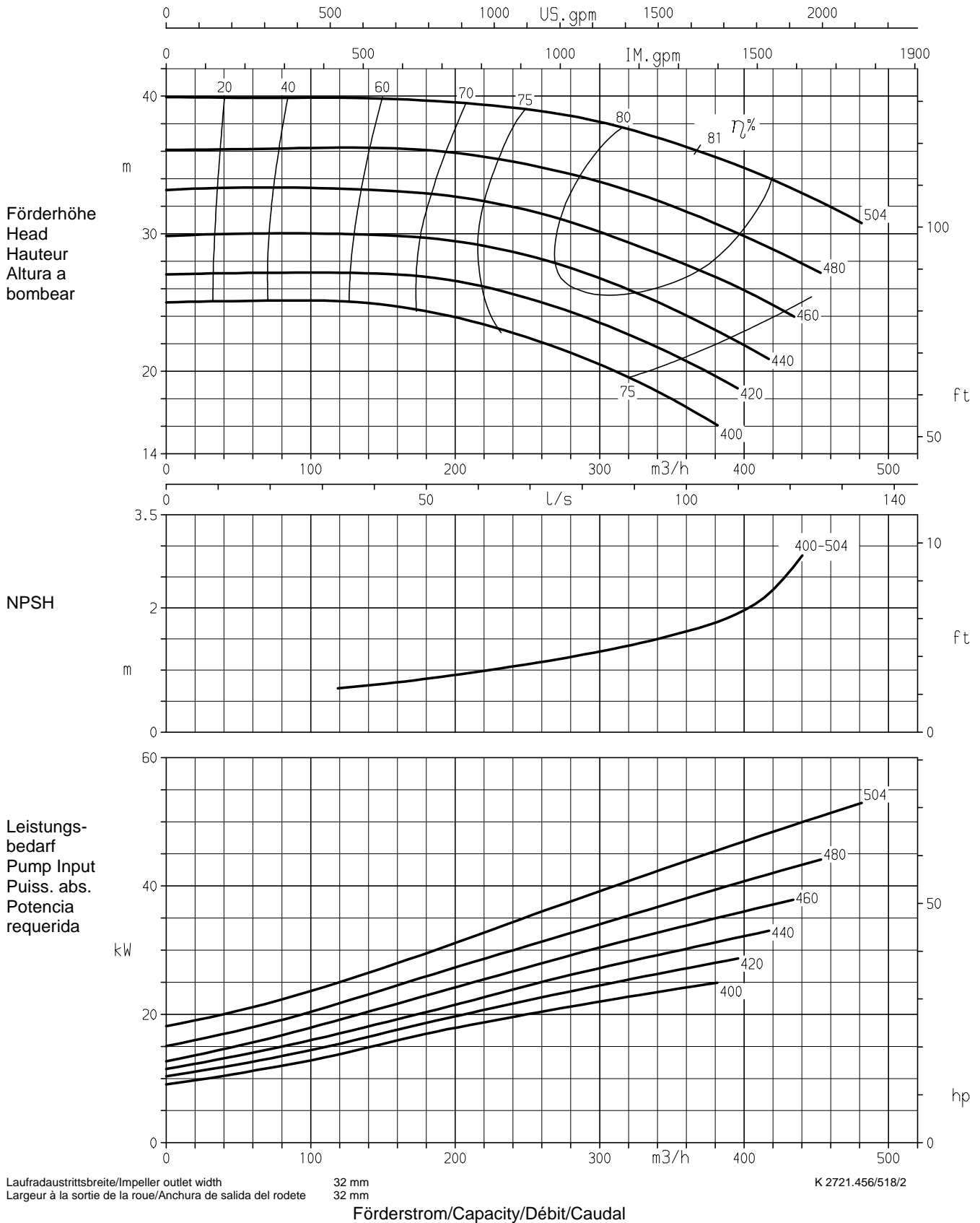

Baureihe Pump type	Modèle Tipo	Nenn Drehzahl Nom. speed	Vitesse nom. Revoluciones nom.	 KSB KSB Aktiengesellschaft Pumpen Industrie- und Wassertechnik Postfach 13 60, D-91253 Pegnitz Bahnhofplatz 1, D-91257
CPK/HPK	200-500	960 1/min		
Angebots-Nr. Project No.	No. de l'offre Oferta-No.	Pos.-Nr. Item No.	No. de pos. No. de pos.	



Baureihe Pump type	Modèle Tipo	Nenn Drehzahl Nom. speed	Vitesse nom. Revoluciones nom.	 KSB KSB Aktiengesellschaft Pumpen Industrie- und Wassertechnik Postfach 13 60, D-91253 Pegnitz Bahnhofplatz 1, D-91257
CPK/HPK	250-315	960 1/min		
Angebots-Nr. Project No.	No. de l'offre Oferta-No.	Pos.-Nr. Item No.	No. de pos. No. de pos.	

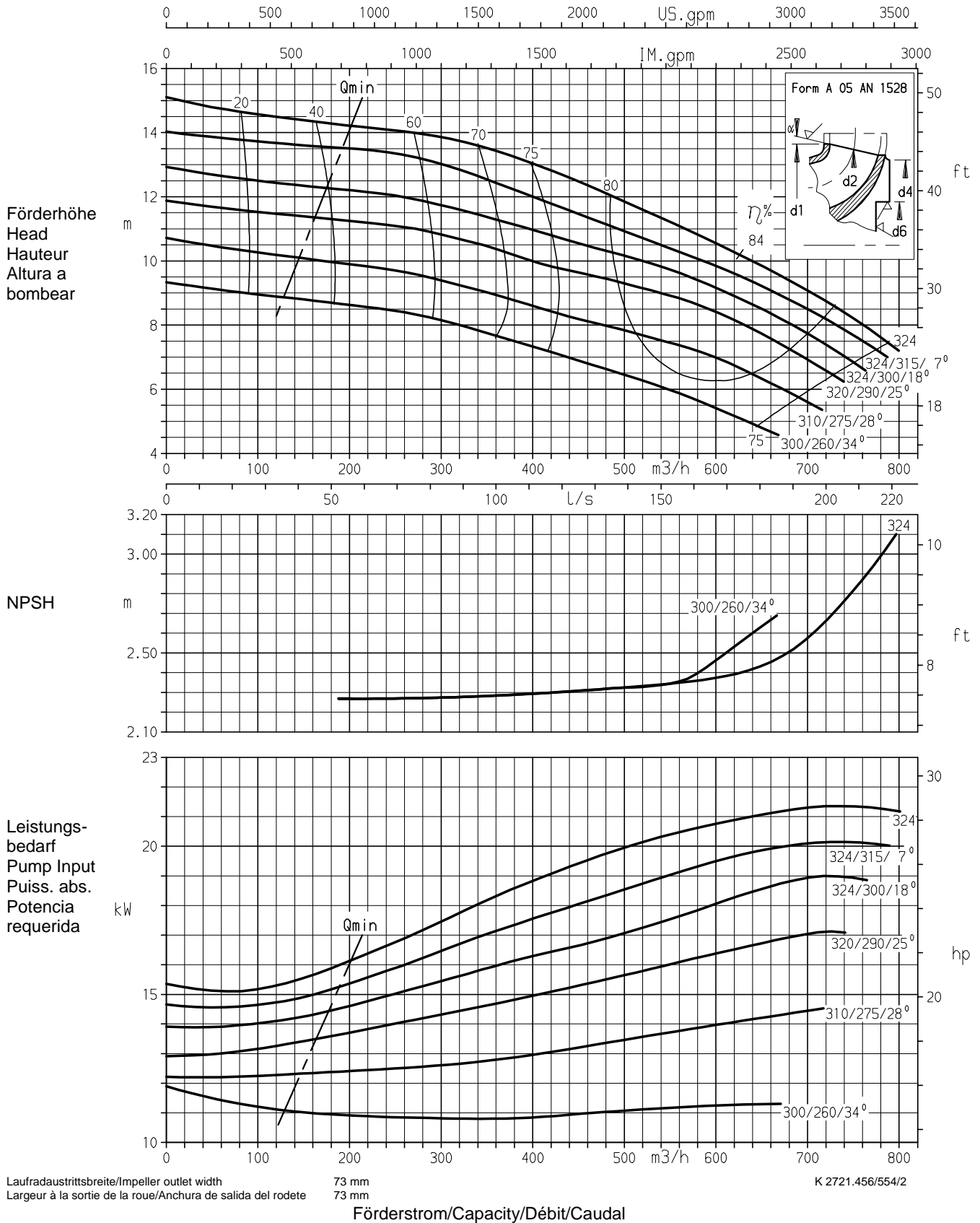

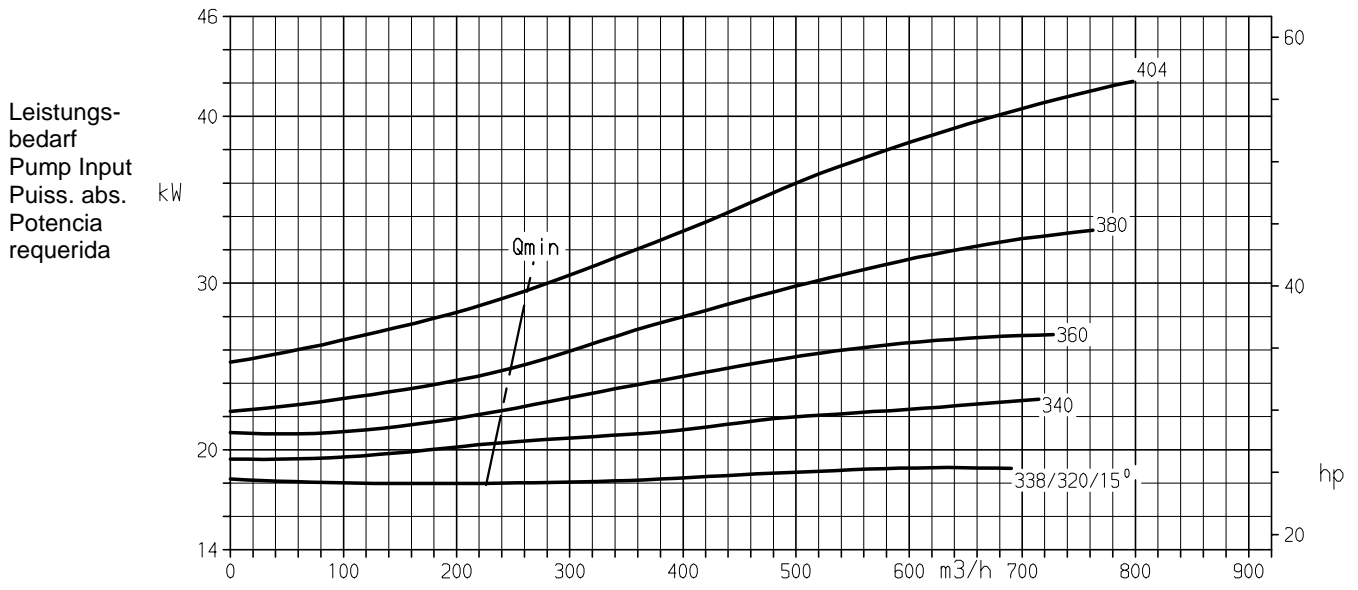
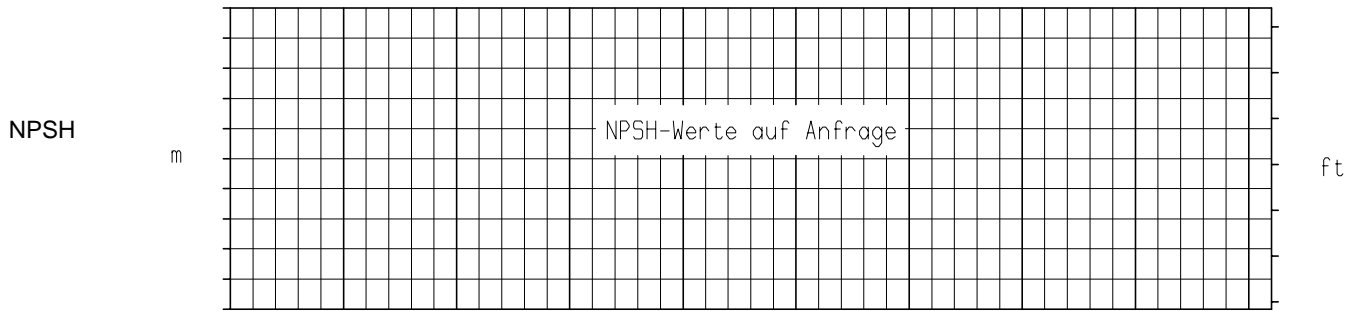
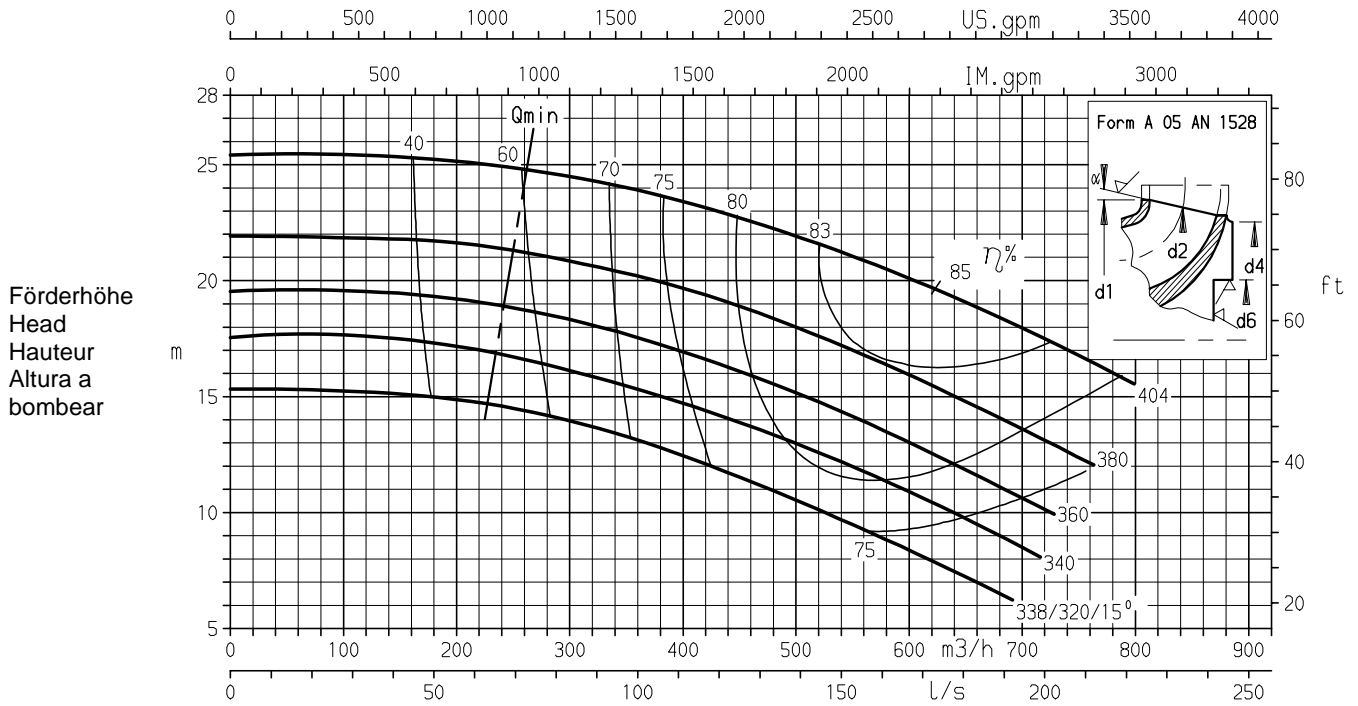

Baureihe Pump type	Modèle Tipo	Neendrehzahl Nom. speed	Vitesse nom. Revoluciones nom.	 KSB KSB Aktiengesellschaft Pumpen Industrie- und Wassertechnik Postfach 13 60, D-91253 Pegnitz Bahnhofplatz 1, D-91257
CPK/HPK	250-400	960 1/min		
Angebots-Nr. Project No.	No. de l'offre Oferta-No.	Pos.-Nr. Item No.	No. de pos. No. de pos.	

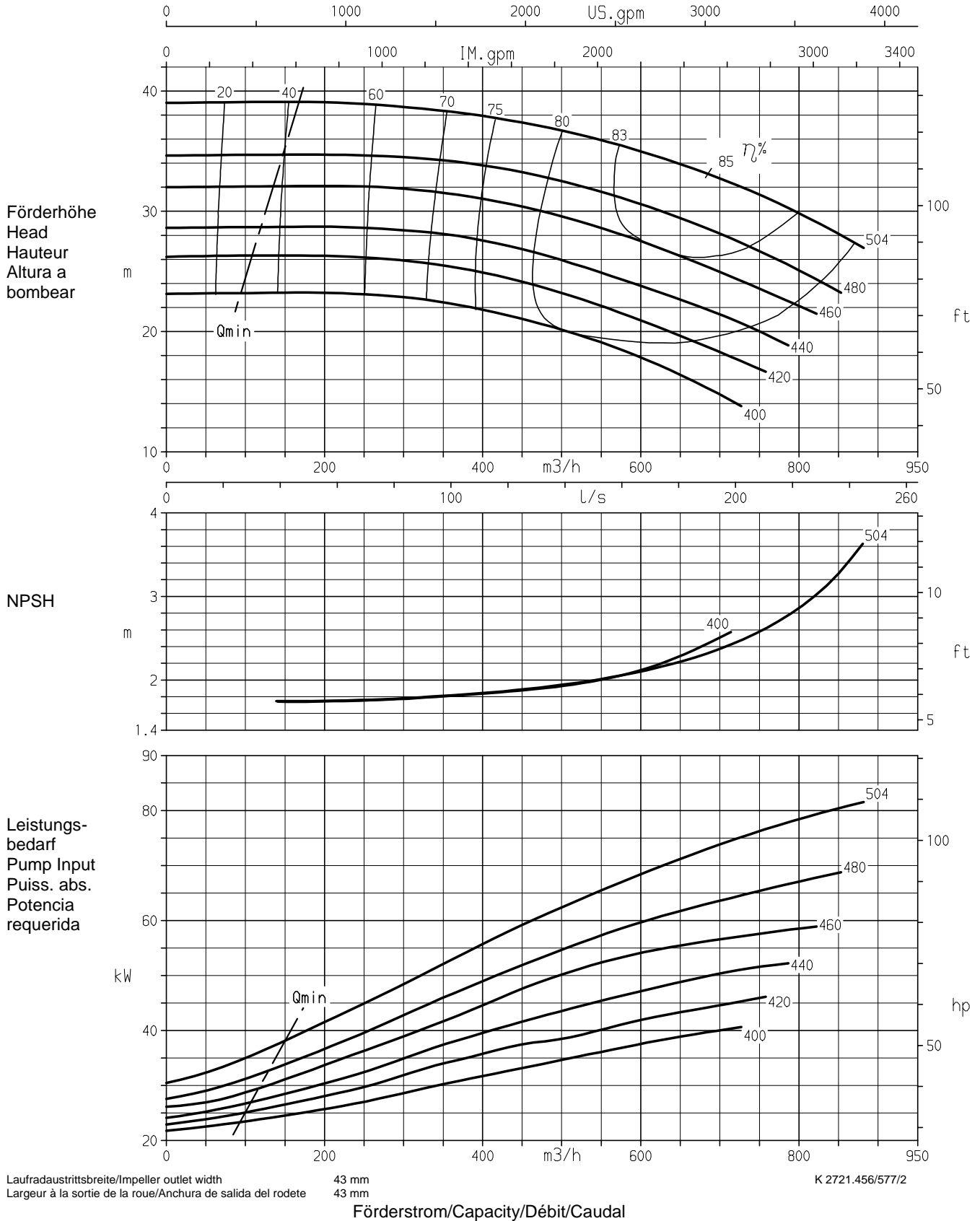

Laufradaustrittsbreite/Impeller outlet width 63 mm
 Largeur à la sortie de la roue/Anchura de salida del rodeté 63 mm
 Förderstrom/Capacity/Débit/Caudal K 2721.456/556/2

Baureihe Pump type	Modèle Tipo	Nennzahl Nom. speed	Vitesse nom. Revoluciones nom.	 KSB KSB Aktiengesellschaft Pumpen Industrie- und Wassertechnik Postfach 13 60, D-91253 Pegnitz Bahnhofplatz 1, D-91257
CPK/HPK	250-500	960 1/min		
Angebots-Nr. Project No.	No. de l'offre Oferta-No.	Pos.-Nr. Item No.	No. de pos. No. de pos.	



Baureihe Pump type CPK/HPK A-Rad	Modèle Tipo 300-400	Nenn Drehzahl Nom. speed 960 1/min	Vitesse nom. Revoluciones nom.	 KSB KSB Aktiengesellschaft Pumpen Industrie- und Wassertechnik Postfach 13 60, D-91253 Pegnitz Bahnhofplatz 1, D-91257
Angebots-Nr. Project No.	No. de l'offre Oferta-No.	Pos.-Nr. Item No.	No. de pos. No. de pos.	

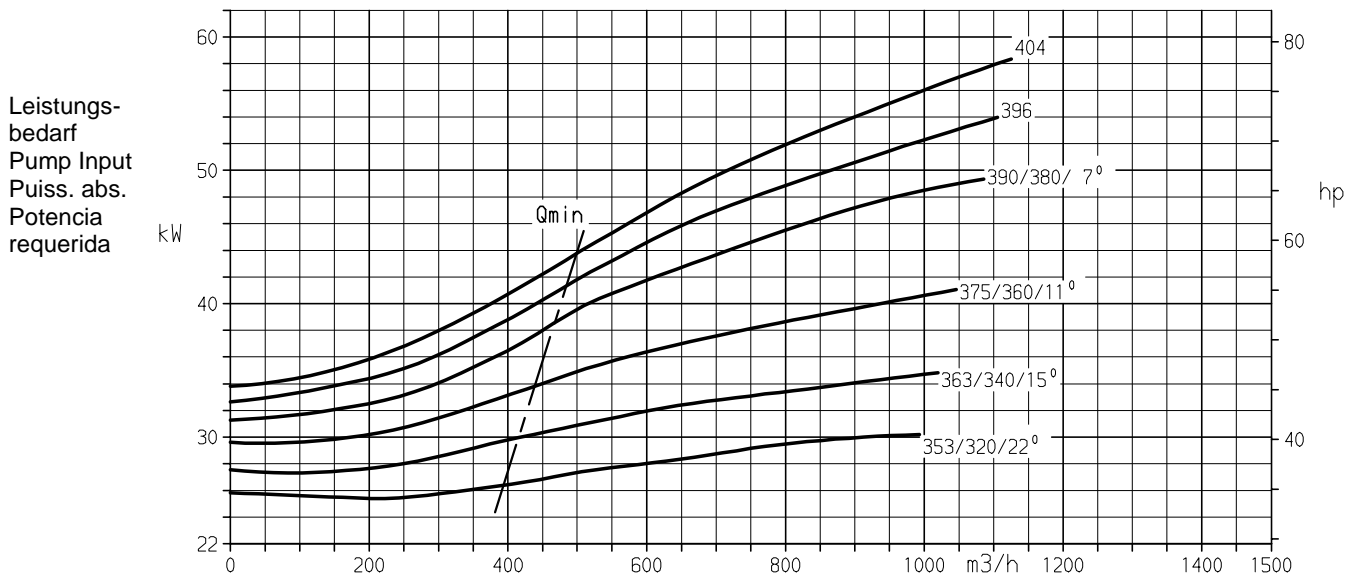
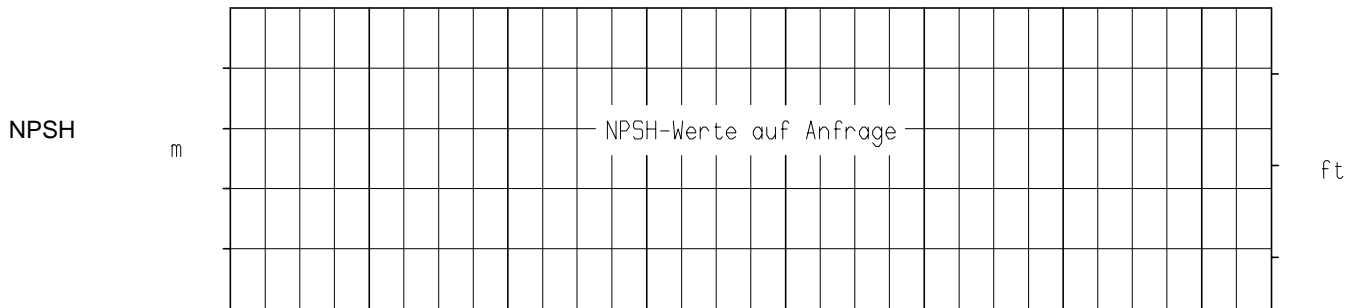
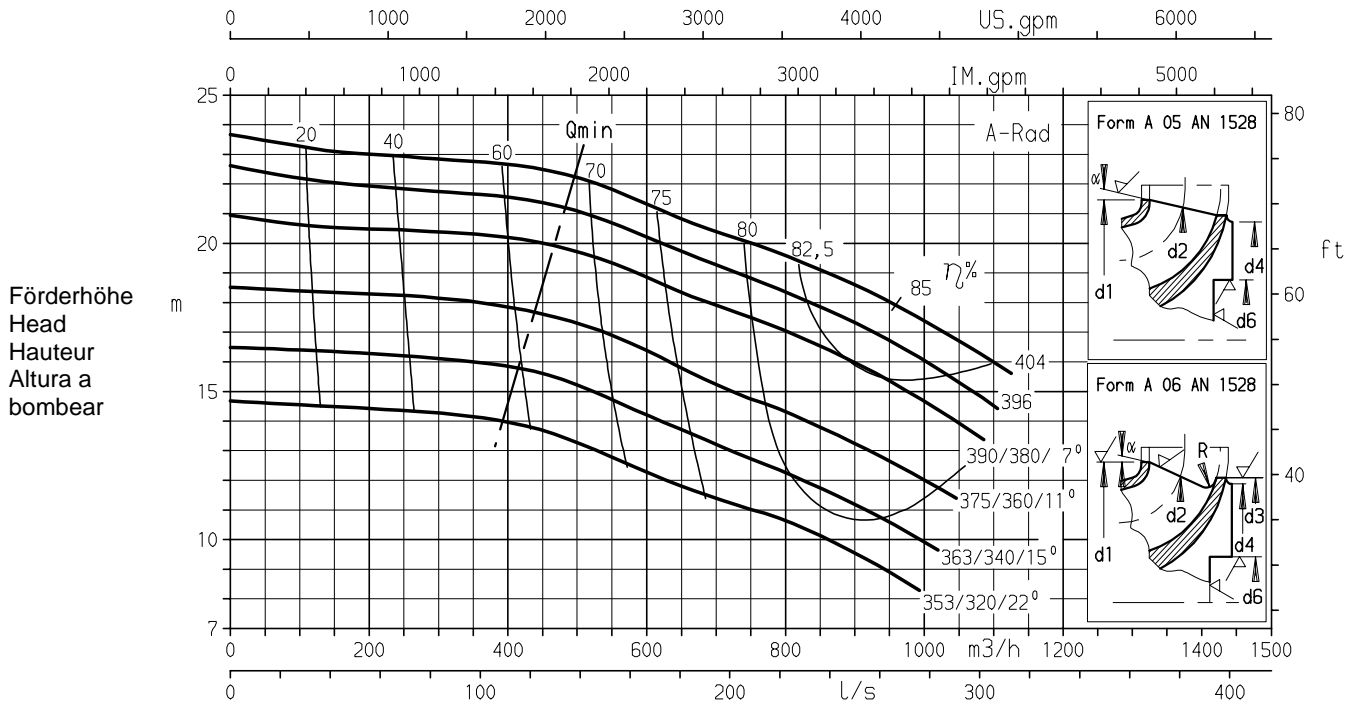



Laufradaustrittsbreite/Impeller outlet width 68 mm
 Largeur à la sortie de la roue/Anchura de salida del rodeté 68 mm

Förderstrom/Capacity/Débit/Caudal

K 2721.456/606/2

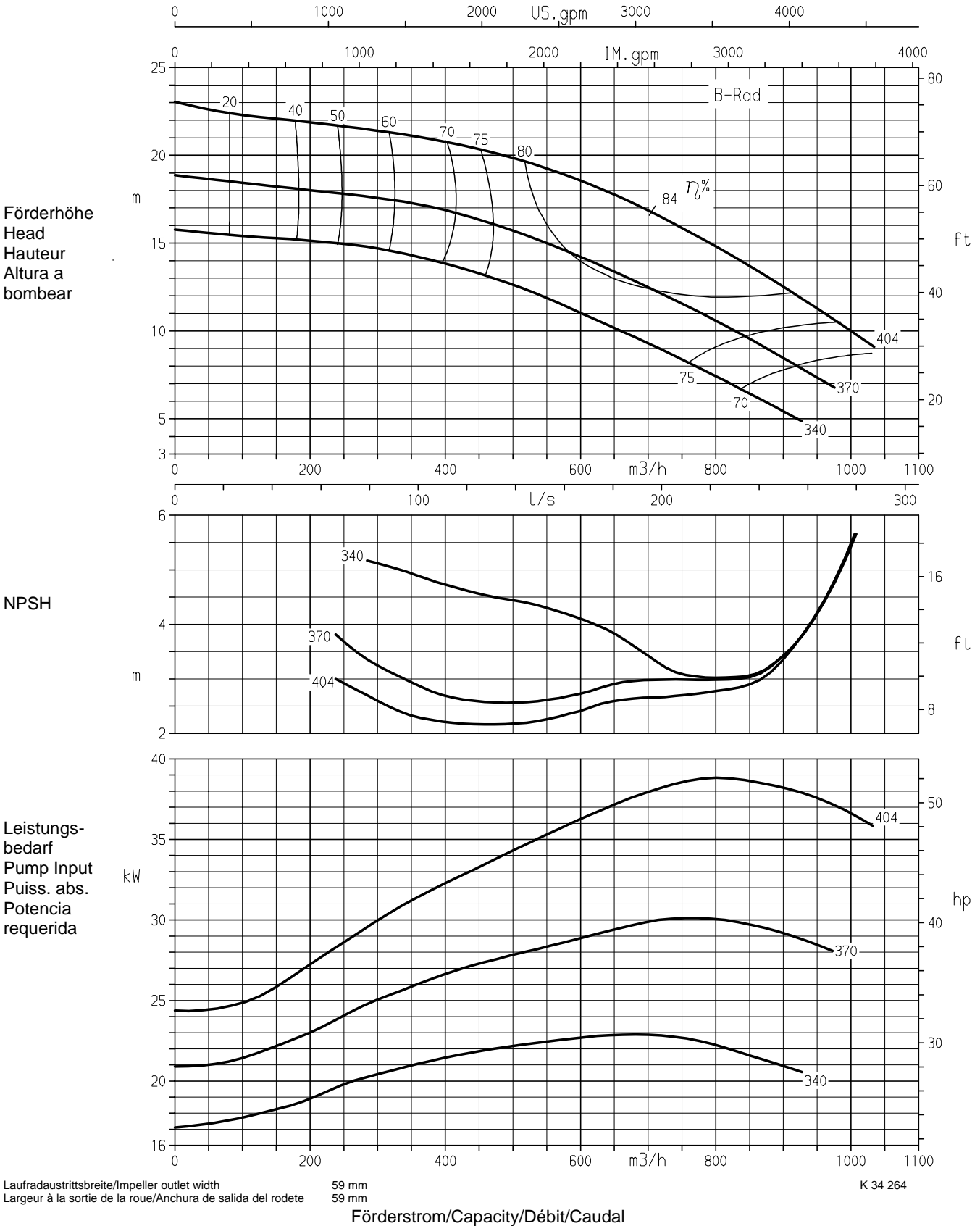
Baureihe Pump type CPK/HPK B-Rad	Modèle Tipo 300-400	Nennzahl Nom. speed 960 1/min	Vitesse nom. Revoluciones nom.	 <p>KSB KSB Aktiengesellschaft Pumpen Industrie- und Wassertechnik Postfach 13 60, D-91253 Pegnitz Bahnhofplatz 1, D-91257</p>
Angebots-Nr. Project No.	No. de l'offre Oferta-No.	Pos.-Nr. Item No.	No. de pos. No. de pos.	



Baureihe Pump type	Modèle Tipo	Nennndrehzahl Nom. speed	Vitesse nom. Revoluciones nom.	 KSB KSB Aktiengesellschaft Pumpen Industrie- und Wassertechnik Postfach 13 60, D-91253 Pegnitz Bahnhofplatz 1, D-91257
CPK/HPK	300-500	960 1/min		
Angebots-Nr. Project No.	No. de l'offre Oferta-No.	Pos.-Nr. Item No.	No. de pos. No. de pos.	

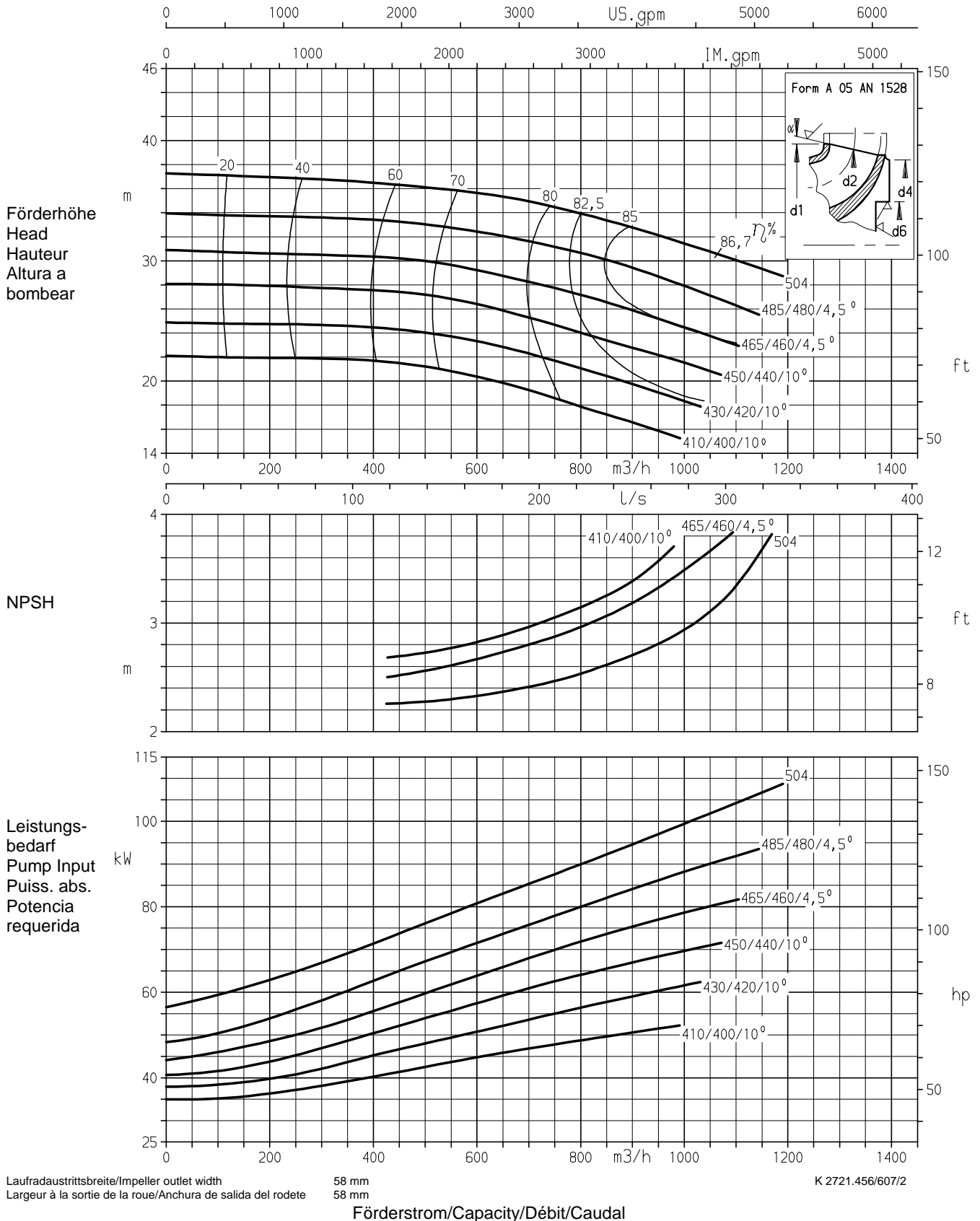

Baureihe Pump type CPK/HPK A-Rad	Modèle Tipo 350-400	Nenndrehzahl Nom. speed 960 1/min	Vitesse nom. Revoluciones nom.	 KSB KSB Aktiengesellschaft Pumpen Industrie- und Wassertechnik Postfach 13 60, D-91253 Pegnitz Bahnhofplatz 1, D-91257
Angebots-Nr. Project No.	No. de l'offre Oferta-No.	Pos.-Nr. Item No.	No. de pos. No. de pos.	

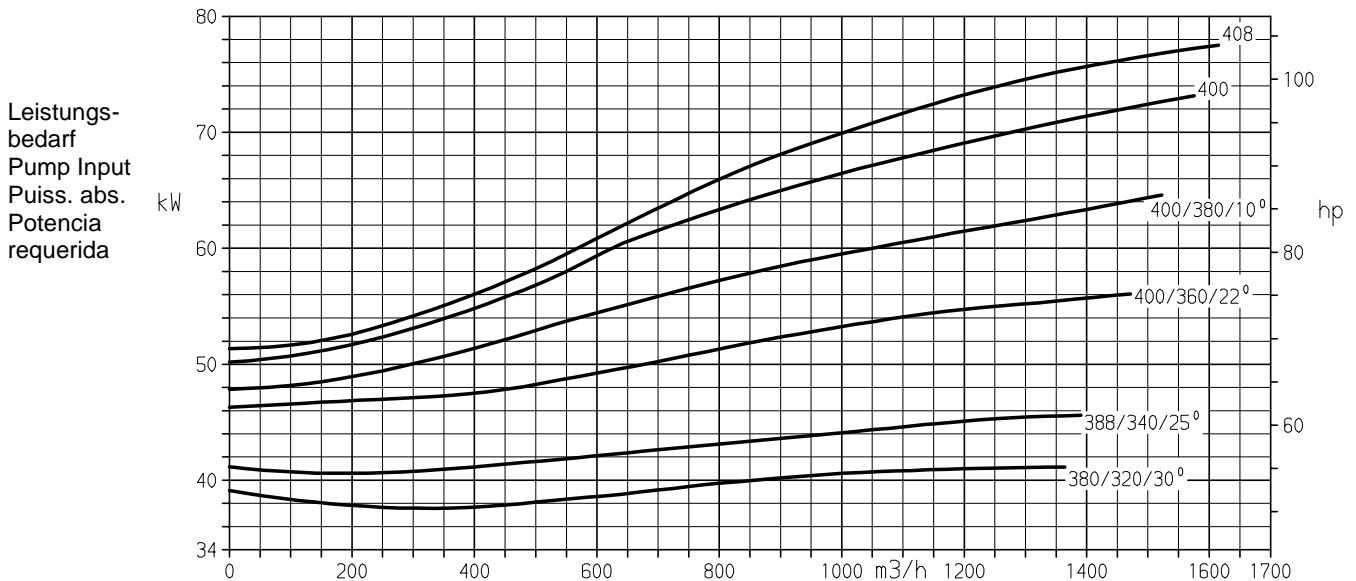
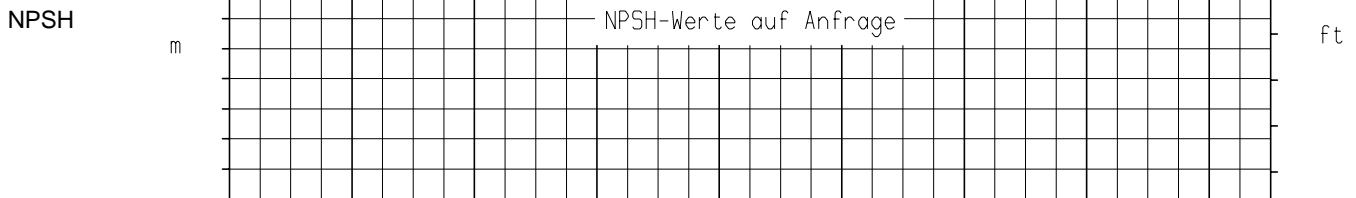
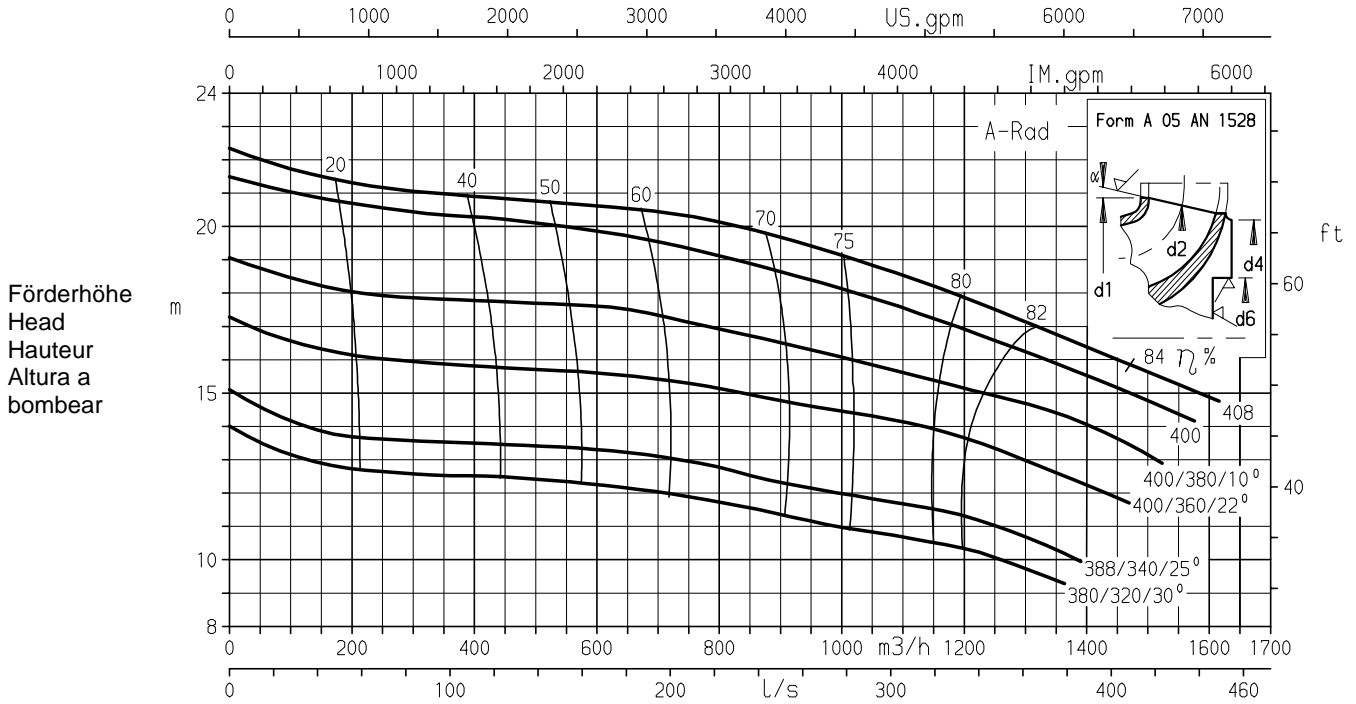

Laufradaustrittsbreite/Impeller outlet width
Largeur à la sortie de la roue/Anchura de salida del rodete

115 mm
115 mm

K 2721.456/625/2

Förderstrom/Capacity/Débit/Caudal

Baureihe Pump type CPK/HPK B-Rad	Modèle Tipo 350-400	Nenn Drehzahl Nom. speed 960 1/min	Vitesse nom. Revoluciones nom.	 KSB KSB Aktiengesellschaft Pumpen Industrie- und Wassertechnik Postfach 13 60, D-91253 Pegnitz Bahnhofplatz 1, D-91257
Angebots-Nr. Project No.	No. de l'offre Oferta-No.	Pos.-Nr. Item No.	No. de pos. No. de pos.	

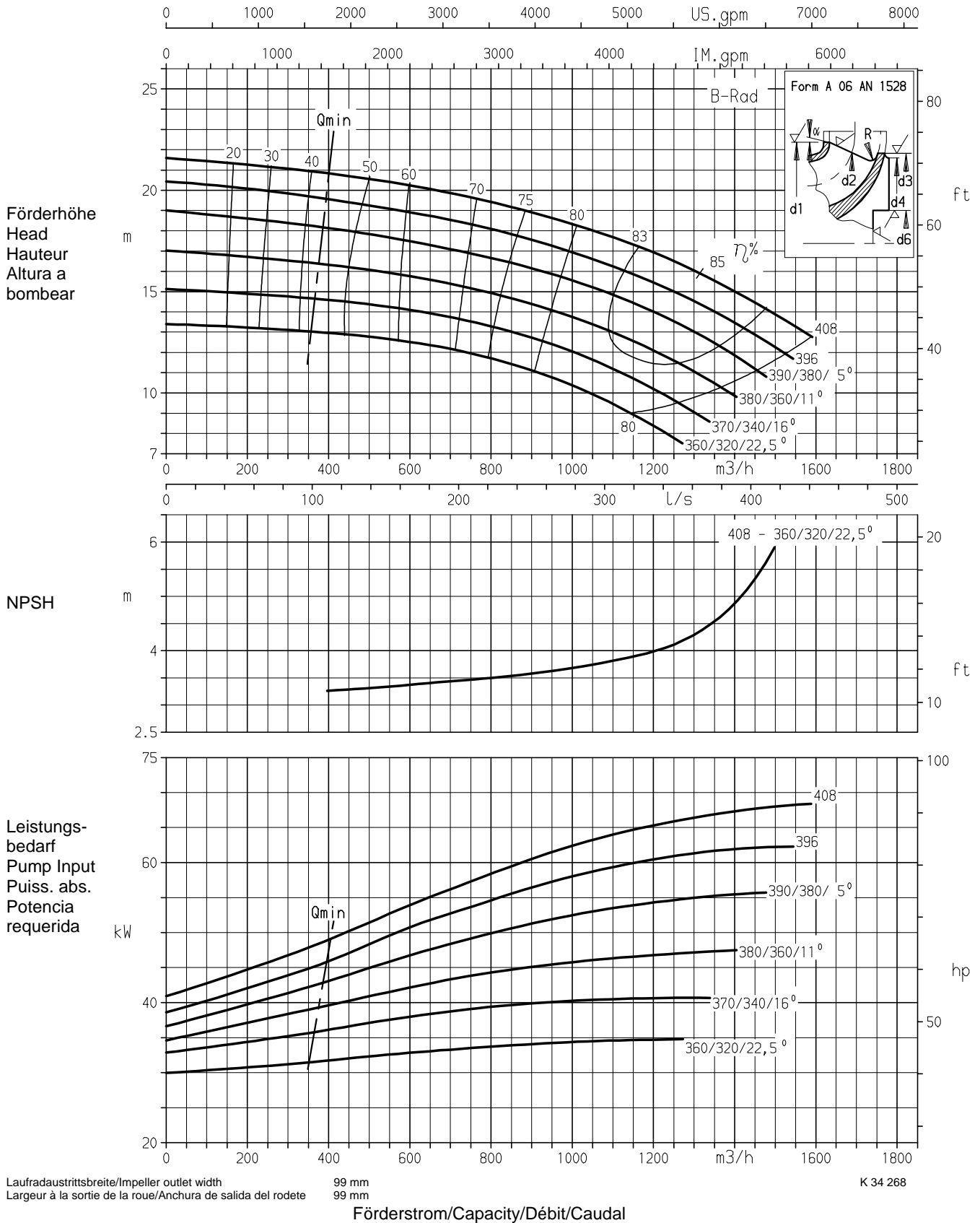

Baureihe Pump type	Modèle Tipo	Nenn Drehzahl Nom. speed	Vitesse nom. Revoluciones nom.	 KSB KSB Aktiengesellschaft Pumpen Industrie- und Wassertechnik Postfach 13 60, D-91253 Pegnitz Bahnhofplatz 1, D-91257
CPK/HPK	350-500	960 1/min		
Angebots-Nr. Project No.	No. de l'offre Oferta-No.	Pos.-Nr. Item No.	No. de pos. No. de pos.	

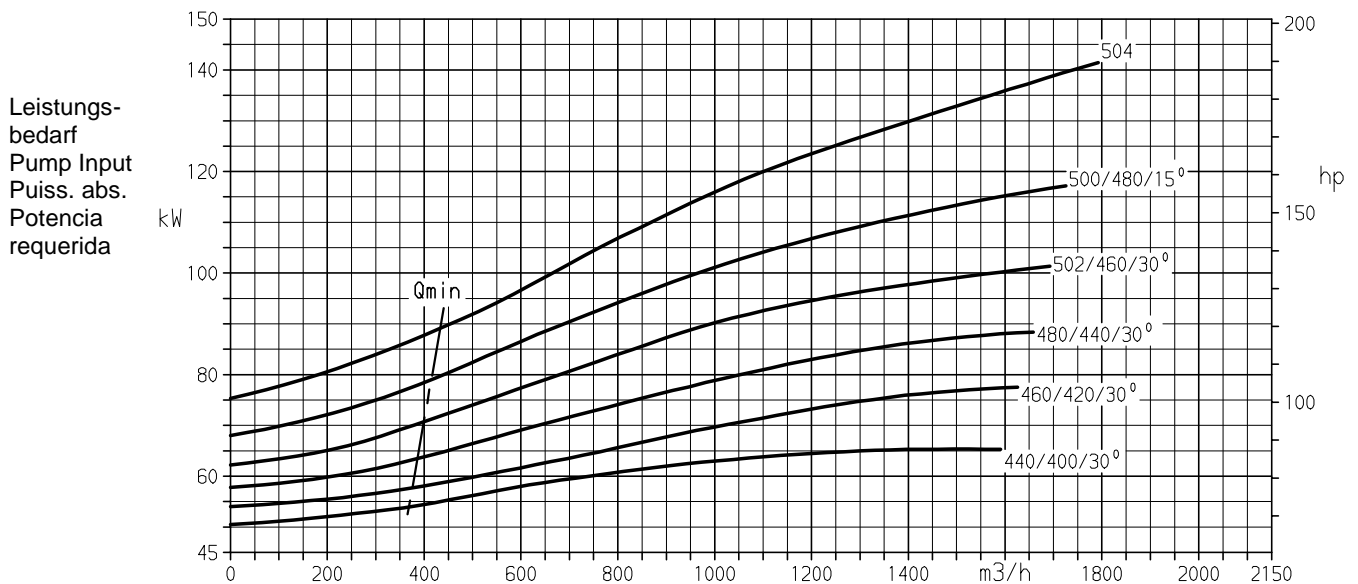
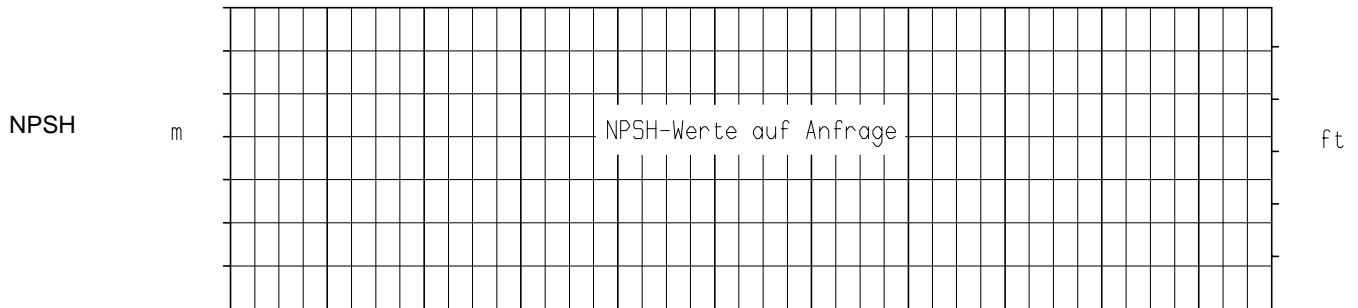
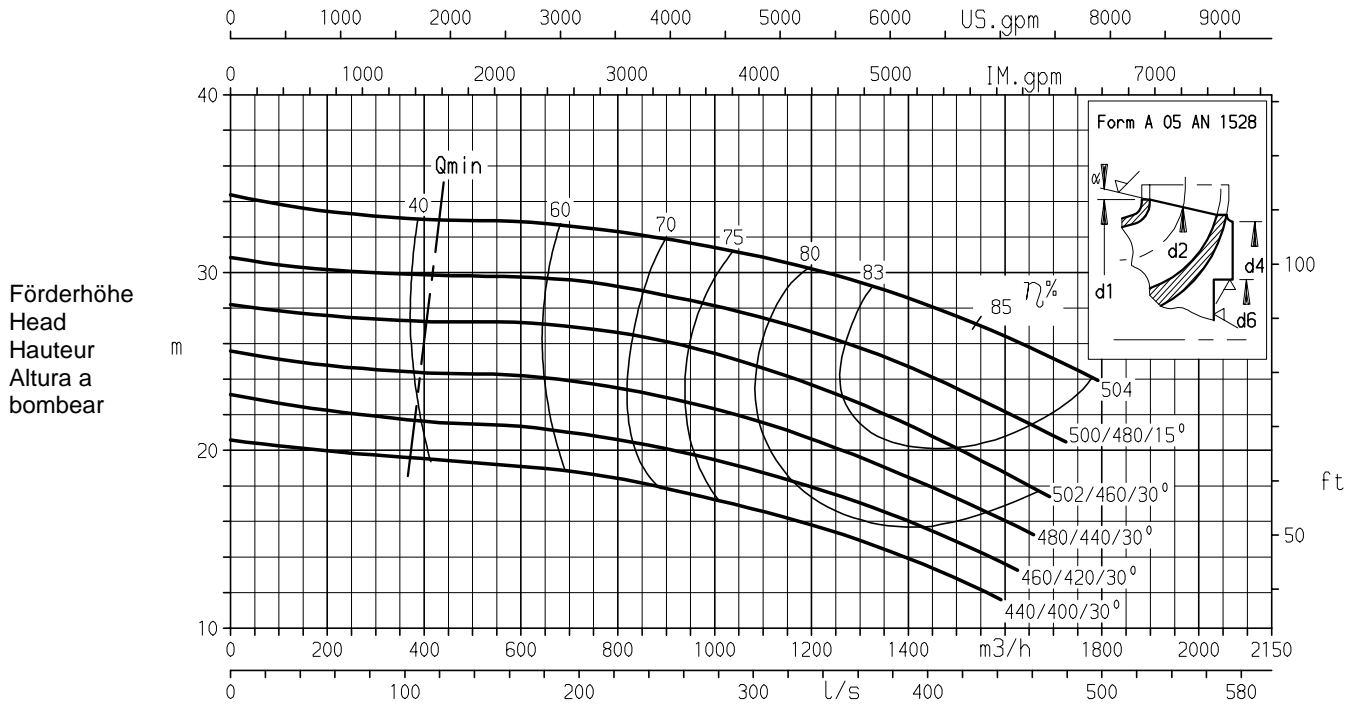

Laufraudausrittsbreite/Impeller outlet width
Largeur à la sortie de la roue/Anchura de salida del rodete

72 mm
72 mm

K 2721.456/608/2

Förderstrom/Capacity/Débit/Caudal

